



**ASRock®**



**970M Pro3**

User Manual

Version 1.0

Published January 2015

Copyright©2015 ASRock INC. All rights reserved.

### Copyright Notice:

No part of this documentation may be reproduced, transcribed, transmitted, or translated in any language, in any form or by any means, except duplication of documentation by the purchaser for backup purpose, without written consent of ASRock Inc.

Products and corporate names appearing in this documentation may or may not be registered trademarks or copyrights of their respective companies, and are used only for identification or explanation and to the owners' benefit, without intent to infringe.

### Disclaimer:

Specifications and information contained in this documentation are furnished for informational use only and subject to change without notice, and should not be constructed as a commitment by ASRock. ASRock assumes no responsibility for any errors or omissions that may appear in this documentation.

With respect to the contents of this documentation, ASRock does not provide warranty of any kind, either expressed or implied, including but not limited to the implied warranties or conditions of merchantability or fitness for a particular purpose.

In no event shall ASRock, its directors, officers, employees, or agents be liable for any indirect, special, incidental, or consequential damages (including damages for loss of profits, loss of business, loss of data, interruption of business and the like), even if ASRock has been advised of the possibility of such damages arising from any defect or error in the documentation or product.



This device complies with Part 15 of the FCC Rules. Operation is subject to the following two conditions:

- (1) this device may not cause harmful interference, and
- (2) this device must accept any interference received, including interference that may cause undesired operation.

### CALIFORNIA, USA ONLY

The Lithium battery adopted on this motherboard contains Perchlorate, a toxic substance controlled in Perchlorate Best Management Practices (BMP) regulations passed by the California Legislature. When you discard the Lithium battery in California, USA, please follow the related regulations in advance.

“Perchlorate Material-special handling may apply, see [www.dtsc.ca.gov/hazardouswaste/perchlorate](http://www.dtsc.ca.gov/hazardouswaste/perchlorate)”

**ASRock Website: <http://www.asrock.com>**

# Contents

<b>Chapter 1 Introduction</b>	<b>1</b>
1.1 Package Contents	1
1.2 Specifications	2
1.3 Motherboard Layout	6
1.4 I/O Panel	8
<b>Chapter 2 Installation</b>	<b>10</b>
2.1 Installing the CPU	11
2.2 Installing the CPU Fan and Heatsink	13
2.3 Installing Memory Modules (DIMM)	14
2.4 Expansion Slots (PCI and PCI Express Slots)	16
2.5 Jumpers Setup	17
2.6 Onboard Headers and Connectors	18
2.7 CrossFireX™ and Quad CrossFireX™ Operation Guide	22
2.7.1 Installing Two CrossFireX™-Ready Graphics Cards	22
2.7.2 Driver Installation and Setup	24
<b>Chapter 3 Software and Utilities Operation</b>	<b>25</b>
3.1 Installing Drivers	25
3.2 ASRock EXTREME TUNING UTILITY	26
3.3 ASRock APP Shop	31
3.3.1 UI Overview	31
3.3.2 Apps	32
3.3.3 BIOS & Drivers	35

3.3.4	Setting	36
3.4	Start8	37
<b>Chapter 4 UEFI SETUP UTILITY</b>		<b>40</b>
4.1	Introduction	40
4.1.1	UEFI Menu Bar	40
4.1.2	Navigation Keys	41
4.2	Main Screen	42
4.3	OC Tweaker Screen	43
4.4	Advanced Screen	47
4.4.1	CPU Configuration	48
4.4.2	North Bridge Configuration	50
4.4.3	South Bridge Configuration	51
4.4.4	Storage Configuration	52
4.4.5	Super IO Configuration	54
4.4.6	ACPI Configuration	55
4.4.7	USB Configuration	57
4.4.8	Trusted Computing	58
4.5	Tools	59
4.6	Hardware Health Event Monitoring Screen	62
4.7	Boot Screen	63
4.8	Security Screen	66
4.9	Exit Screen	67

# Chapter 1 Introduction

Thank you for purchasing ASRock 970M Pro3 motherboard, a reliable motherboard produced under ASRock's consistently stringent quality control. It delivers excellent performance with robust design conforming to ASRock's commitment to quality and endurance.

In this manual, Chapter 1 and 2 contains the introduction of the motherboard and step-by-step installation guides. Chapter 3 contains the operation guide of the software and utilities. Chapter 4 contains the configuration guide of the BIOS setup.



*Because the motherboard specifications and the BIOS software might be updated, the content of this manual will be subject to change without notice. In case any modifications of this manual occur, the updated version will be available on ASRock's website without further notice. If you require technical support related to this motherboard, please visit our website for specific information about the model you are using. You may find the latest VGA cards and CPU support list on ASRock's website as well. ASRock website <http://www.asrock.com>.*

## 1.1 Package Contents

- ASRock 970M Pro3 Motherboard (Micro ATX Form Factor)
- ASRock 970M Pro3 Quick Installation Guide
- ASRock 970M Pro3 Support CD
- 2 x Serial ATA (SATA) Data Cables (Optional)
- 1 x I/O Panel Shield

## 1.2 Specifications

- Platform**
- Micro ATX Form Factor
  - Solid Capacitor design
  - High Density Glass Fabric PCB

- CPU**
- Supports Socket AM3+ processors
  - Supports Socket AM3 processors: AMD Phenom™ II X6 / X4 / X3 / X2 (except 920 / 940) / Athlon II X4 / X3 / X2 / Sempron processors
  - Supports 8-Core CPU
  - Supports UCC feature (Unlock CPU Core)
  - 4 + 1 Power Phase design
  - Supports CPU up to 140W
  - Supports AMD's Cool 'n' Quiet Technology
  - FSB 2400 MHz (4.8 GT/s)
  - Supports Untied Overclocking Technology
  - Supports Hyper-Transport 3.0 (HT 3.0) Technology

- Chipset**
- Northbridge: AMD 970
  - Southbridge: AMD SB950

- Memory**
- Dual Channel DDR3 Memory Technology
  - 4 x DDR3 DIMM Slots
  - Supports DDR3 2400+(OC)/2100(OC)/1866(OC)/1800(OC)/1600(OC)/1333/1066 non-ECC, un-buffered memory (see CAUTION1)
  - Max. capacity of system memory: 64GB (see CAUTION2)
  - Supports Intel® Extreme Memory Profile (XMP) 1.3 / 1.2
  - Supports AMD Memory Profile Technology (AMP) up to AMP 2400

- Expansion Slot**
- 2 x PCI Express 2.0 x16 Slots (PCIe2: x16 mode; PCIe3: x4 mode)
  - 1 x PCI Express 2.0 x1 Slot
  - 1 x PCI Slot
  - Supports AMD Quad CrossFireX™ and CrossFireX™

**Audio**

- 7.1 CH HD Audio with Content Protection (Realtek ALC892 Audio Codec)

\*To configure 7.1 CH HD Audio, it is required to use an HD front panel audio module and enable the multi-channel audio feature through the audio driver.

- Premium Blu-ray Audio support
- Supports Surge Protection (ASRock Full Spike Protection)
- ELNA Audio Caps

**LAN**

- PCIE x1 Gigabit LAN 10/100/1000 Mb/s
- Realtek RTL8111E
- Supports Wake-On-LAN
- Supports Lightning/ESD Protection (ASRock Full Spike Protection)
- Supports LAN Cable Detection
- Supports Energy Efficient Ethernet 802.3az
- Supports PXE

**Rear Panel I/O**

- 1 x PS/2 Mouse Port
- 1 x PS/2 Keyboard Port
- 6 x USB 2.0 Ports (Supports ESD Protection (ASRock Full Spike Protection))
- 2 x USB 3.0 Ports (Etron EJ188H) (Supports ESD Protection (ASRock Full Spike Protection))
- 1 x RJ-45 LAN Port with LED (ACT/LINK LED and SPEED LED)
- HD Audio Jacks: Line in / Front Speaker / Microphone

**Storage**

- 6 x SATA3 6.0 Gb/s Connectors, support RAID (RAID 0, RAID 1, RAID 5 and RAID 10), NCQ, AHCI and Hot Plug

**Connector**

- 1 x IR Header
- 1 x TPM Header
- 1 x Power LED Header
- 1 x CPU Fan Connector (4-pin)
- 1 x Chassis Fan Connector (4-pin)
- 1 x Power Fan Connector (3-pin)
- 1 x 24 pin ATX Power Connector

- 1 x 8 pin 12V Power Connector
- 1 x Front Panel Audio Connector
- 2 x USB 2.0 Headers (Support 4 USB 2.0 ports) (Supports ESD Protection (ASRock Full Spike Protection))
- 1 x USB 3.0 Header by Etron EJ188H (Supports 2 USB 3.0 ports) (Supports ESD Protection (ASRock Full Spike Protection))

**BIOS  
Feature**

- 32Mb AMI UEFI Legal BIOS with with GUI support
- Supports “Plug and Play”
- ACPI 1.1 Compliant wake up events
- Supports jumperfree
- SMBIOS 2.3.1 support
- CPU, VCCM, NB Voltage multi-adjustment

**Hardware  
Monitor**

- CPU/Chassis temperature sensing
- CPU/Chassis/Power Fan Tachometer
- CPU/Chassis Quiet Fan (Auto adjust fan speed by CPU temperature)
- CPU/Chassis Fan multi-speed control
- Voltage monitoring: +12V, +5V, +3.3V, CPU Vcore Voltage

**OS**

- Microsoft® Windows® 8.1 32-bit / 8.1 64-bit / 8 32-bit / 8 64-bit / 7 32-bit / 7 64-bit / Vista™ 32-bit / Vista™ 64-bit / XP 32-bit / XP 64-bit

**Certifica-  
tions**

- FCC, CE, WHQL
- ErP/EuP ready (ErP/EuP ready power supply is required)

\* For detailed product information, please visit our website: <http://www.asrock.com>





*Please realize that there is a certain risk involved with overclocking, including adjusting the setting in the BIOS, applying Untied Overclocking Technology, or using third-party overclocking tools. Overclocking may affect your system's stability, or even cause damage to the components and devices of your system. It should be done at your own risk and expense. We are not responsible for possible damage caused by overclocking.*



- 1. Whether 2400/2100MHz memory speed is supported depends on the AM3/AM3+ CPU you adopt. If you want to adopt DDR3 2400/2100 memory module on this motherboard, please refer to the memory support list on our website for the compatible memory modules. ASRock website: <http://www.asrock.com>*
- 2. Due to the operating system limitation, the actual memory size may be less than 4GB for the reservation for system usage under Windows® 32-bit OS. For Windows® 64-bit OS with 64-bit CPU, there is no such limitation. You can use ASRock XFast RAM to utilize the memory that Windows® cannot use.*

# 1.3 Motherboard Layout

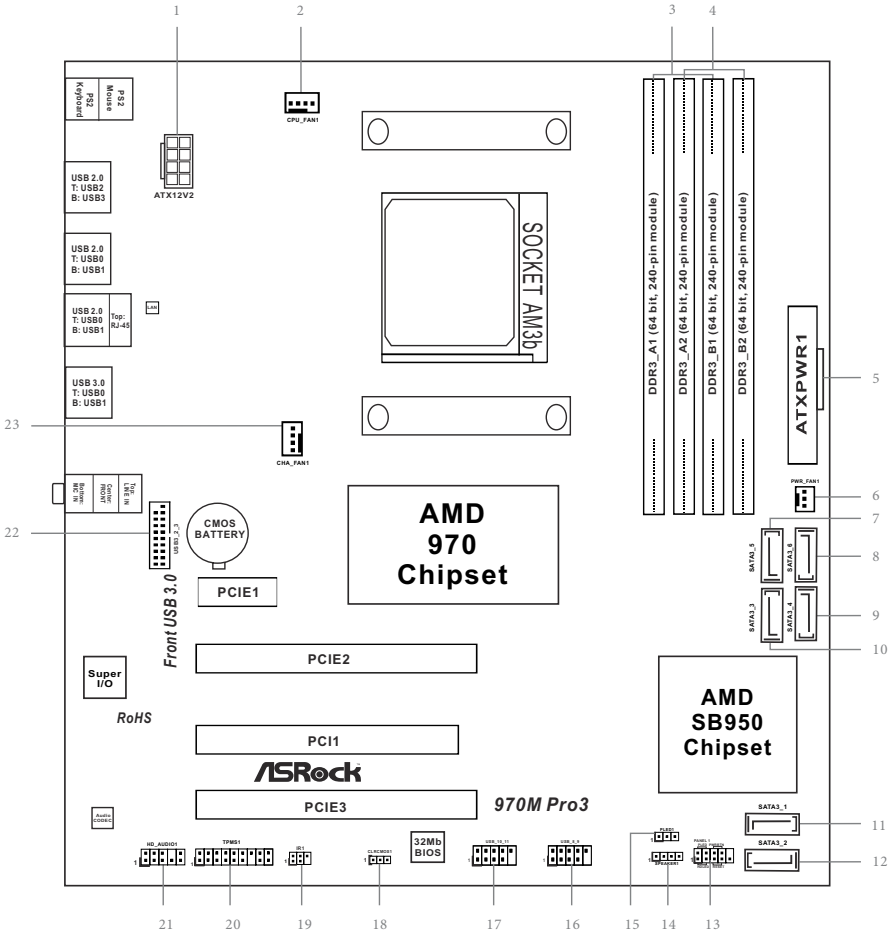

No.	Description
1	ATX 12V Power Connector (ATX12V2)
2	CPU Fan Connector (CPU_FAN1)
3	2 x 240-pin DDR3 DIMM Slots (DDR3_A1, DDR3_B1)
4	2 x 240-pin DDR3 DIMM Slots (DDR3_A2, DDR3_B2)
5	ATX Power Connector (ATXPWR1)
6	Power Fan Connector (PWR_FAN1)
7	SATA3 Connector (SATA3_5)
8	SATA3 Connector (SATA3_6)
9	SATA3 Connector (SATA3_4)
10	SATA3 Connector (SATA3_3)
11	SATA3 Connector (SATA3_1)
12	SATA3 Connector (SATA3_2)
13	System Panel Header (PANEL1)
14	Chassis Speaker Header (SPEAKER1)
15	Power LED Header (PLED1)
16	USB 2.0 Header (USB_8_9)
17	USB 2.0 Header (USB_10_11)
18	Clear CMOS Jumper (CLRCMOS1)
19	Infrared Module Header (IR1)
20	TPM Header (TPMS1)
21	Front Panel Audio Header (HD_AUDIO1)
22	USB 3.0 Header (USB3_2_3)
23	Chassis Fan Connector (CHA_FAN1)

## 1.4 I/O Panel

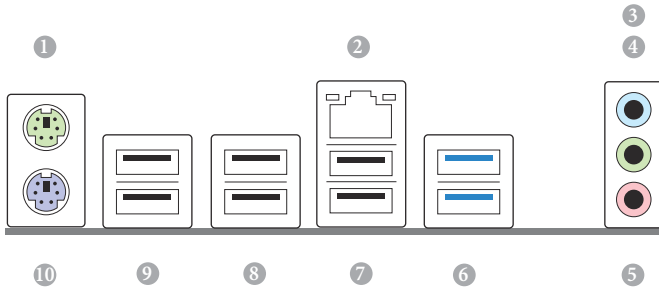

No.	Description	No.	Description
1	PS/2 Mouse Port	8	USB 3.0 Ports (USB3_0_1)
2	LAN RJ-45 Port*	9	USB 2.0 Ports (USB01)
3	Line In (Light Blue)	10	USB 2.0 Ports (USB_0_1)
4	Front Speaker (Lime)**	11	USB 2.0 Ports (USB_2_3)
5	Microphone (Pink)	12	PS/2 Keyboard Port

\* There are two LEDs on each LAN port. Please refer to the table below for the LAN port LED indications.

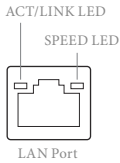

Activity / Link LED		Speed LED	
Status	Description	Status	Description
Off	No Link	Off	10Mbps connection
Blinking	Data Activity	Orange	100Mbps connection
On	Link	Green	1Gbps connection

\*\* If you use a 2-channel speaker, please connect the speaker's plug into "Front Speaker Jack". See the table below for connection details in accordance with the type of speaker you use.

Audio Output Channels	Front Speaker (No. 4)	Line in (No. 3)	Microphone (No. 5)	Front Panel Headphone
2	V	--	--	--
4	V	V	--	--
6	V	V	V	--
8	V	V	V	V



To enable Multi-Streaming, you need to connect a front panel audio cable to the front panel audio header. After restarting your computer, you will find the "Mixer" tool on your system. Please select "Mixer Toolbox" , click "Enable playback multi-streaming", and click "ok". Choose "2CH", "4CH", or "6CH" and then you are allowed to select "Realtek HDA Primary output" to use the Rear Speaker, Central/Bass, and Front Speaker, or select "Realtek HDA Audio 2nd output" to use the front panel audio.

## Chapter 2 Installation

This is a Micro ATX form factor motherboard. Before you install the motherboard, study the configuration of your chassis to ensure that the motherboard fits into it.

### Pre-installation Precautions

Take note of the following precautions before you install motherboard components or change any motherboard settings.

- Make sure to unplug the power cord before installing or removing the motherboard. Failure to do so may cause physical injuries to you and damages to motherboard components.
- In order to avoid damage from static electricity to the motherboard's components, NEVER place your motherboard directly on a carpet. Also remember to use a grounded wrist strap or touch a safety grounded object before you handle the components.
- Hold components by the edges and do not touch the ICs.
- Whenever you uninstall any components, place them on a grounded anti-static pad or in the bag that comes with the components.
- When placing screws to secure the motherboard to the chassis, please do not over-tighten the screws! Doing so may damage the motherboard.

## 2.1 Installing the CPU



*Unplug all power cables before installing the CPU.*



3

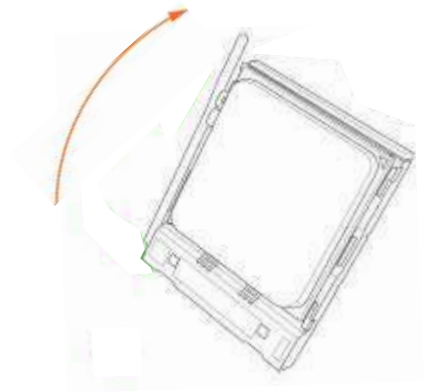



## 2.2 Installing the CPU Fan and Heatsink

After you install the CPU into this motherboard, it is necessary to install a larger heatsink and cooling fan to dissipate heat. You also need to spray thermal grease between the CPU and the heatsink to improve heat dissipation. Make sure that the CPU and the heatsink are securely fastened and in good contact with each other. Then connect the CPU fan to the CPU FAN connector. For proper installation, please kindly refer to the instruction manuals of the CPU fan and the heatsink.

## 2.3 Installing Memory Modules (DIMM)

This motherboard provides four 240-pin DDR3 (Double Data Rate 3) DIMM slots, and supports Dual Channel Memory Technology.



1. For dual channel configuration, you always need to install identical (the same brand, speed, size and chip-type) DDR3 DIMM pairs.
2. It is unable to activate Dual Channel Memory Technology with only one or three memory module installed.
3. It is not allowed to install a DDR or DDR2 memory module into a DDR3 slot; otherwise, this motherboard and DIMM may be damaged.
4. Please install the memory module into DDR3\_A2 and DDR3\_B2 slots for the first priority.
5. If you adopt DDR3 2400/2100 memory modules on this motherboard, it is recommended to install them on DDR3\_A2 and DDR3\_B2 slots.

### Dual Channel Memory Configuration

Priority	DDR3_A1	DDR3_A2	DDR3_B1	DDR3_B2
1		Populated		Populated
2	Populated		Populated	
3	Populated	Populated	Populated	Populated



*The DIMM only fits in one correct orientation. It will cause permanent damage to the motherboard and the DIMM if you force the DIMM into the slot at incorrect orientation.*

1

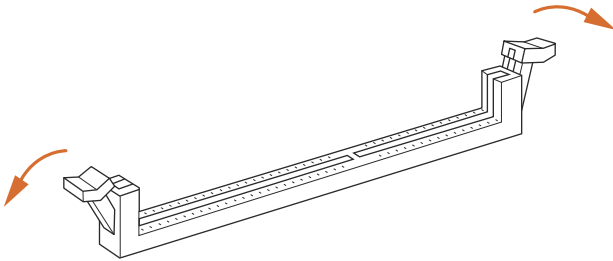

2

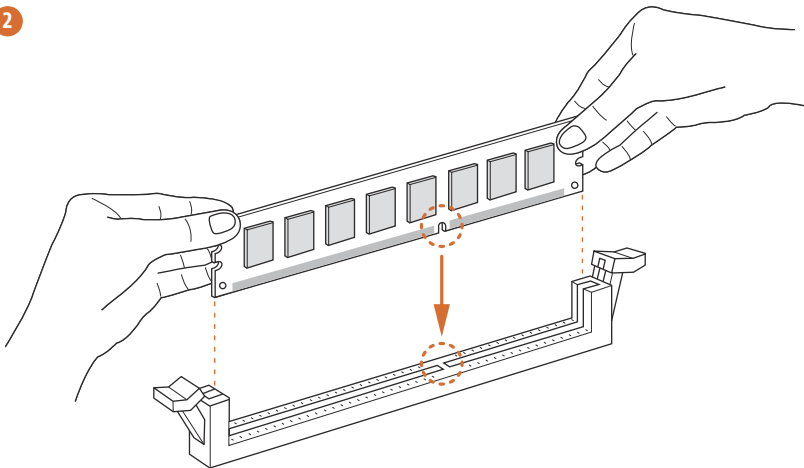

3

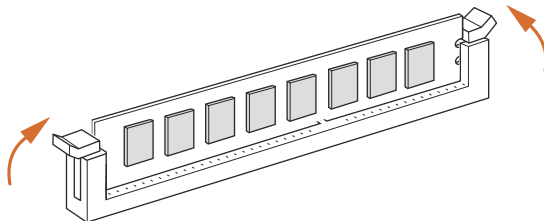

## 2.4 Expansion Slots (PCI and PCI Express Slots)

There is 1 PCI slot and 3 PCI Express slots on the motherboard.



*Before installing an expansion card, please make sure that the power supply is switched off or the power cord is unplugged. Please read the documentation of the expansion card and make necessary hardware settings for the card before you start the installation.*

### PCI slot:

The PCI slot is used to install expansion cards that have 32-bit PCI interface.

### PCIe slots:

PCIe1 (PCIe 2.0 x1 slot) is used for PCI Express x1 lane width cards.

PCIe2 (PCIe 2.0 x16 slot) is used for PCI Express x16 lane width graphics cards.

PCIe3 (PCIe 2.0 x16 slot) is used for PCI Express x4 lane width cards.

### PCIe Slot Configurations

	PCIe2	PCIe3
<b>Single Graphics Card</b>	x16	N/A
<b>Two Graphics Cards in CrossFire™ Mode</b>	x16	x4



*For a better thermal environment, please connect a chassis fan to the motherboard's chassis fan connector (CHA\_FAN1) when using multiple graphics cards.*

## 2.5 Jumpers Setup

The illustration shows how jumpers are setup. When the jumper cap is placed on the pins, the jumper is “Short”. If no jumper cap is placed on the pins, the jumper is “Open”. The illustration shows a 3-pin jumper whose pin1 and pin2 are “Short” when a jumper cap is placed on these 2 pins.



Clear CMOS Jumper  
(CLR CMOS1)  
(see p.6, No. 18)

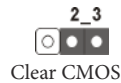

CLR CMOS1 allows you to clear the data in CMOS. To clear and reset the system parameters to default setup, please turn off the computer and unplug the power cord from the power supply. After waiting for 15 seconds, use a jumper cap to short pin2 and pin3 on CLR CMOS1 for 5 seconds. However, please do not clear the CMOS right after you update the BIOS. If you need to clear the CMOS when you just finish updating the BIOS, you must boot up the system first, and then shut it down before you do the clear-CMOS action. Please be noted that the password, date, time, and user default profile will be cleared only if the CMOS battery is removed.

## 2.6 Onboard Headers and Connectors



Onboard headers and connectors are **NOT** jumpers. Do **NOT** place jumper caps over these headers and connectors. Placing jumper caps over the headers and connectors will cause permanent damage to the motherboard.

System Panel Header  
(9-pin PANEL1)  
(see p.6, No. 13)

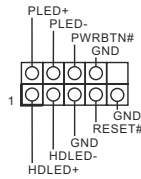

Connect the power switch, reset switch and system status indicator on the chassis to this header according to the pin assignments below. Note the positive and negative pins before connecting the cables.



**PWRBTN (Power Switch):**

Connect to the power switch on the chassis front panel. You may configure the way to turn off your system using the power switch.

**RESET (Reset Switch):**

Connect to the reset switch on the chassis front panel. Press the reset switch to restart the computer if the computer freezes and fails to perform a normal restart.

**PLED (System Power LED):**

Connect to the power status indicator on the chassis front panel. The LED is on when the system is operating. The LED keeps blinking when the system is in S1/S3 sleep state. The LED is off when the system is in S4 sleep state or powered off (S5).

**HDLED (Hard Drive Activity LED):**

Connect to the hard drive activity LED on the chassis front panel. The LED is on when the hard drive is reading or writing data.

The front panel design may differ by chassis. A front panel module mainly consists of power switch, reset switch, power LED, hard drive activity LED, speaker and etc. When connecting your chassis front panel module to this header, make sure the wire assignments and the pin assignments are matched correctly.

Power LED Header  
(3-pin PLED1)  
(see p.6, No. 15)

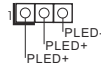

Please connect the chassis power LED to this header to indicate the system's power status.

Serial ATA3 Connectors  
(SATA3\_1:  
see p.6, No. 11)  
(SATA3\_2:  
see p.6, No. 12)  
(SATA3\_3:  
see p.6, No. 10)  
(SATA3\_4:  
see p.6, No. 9)  
(SATA3\_5:  
see p.6, No. 7)  
(SATA3\_6:  
see p.6, No. 8)



These six SATA3 connectors support SATA data cables for internal storage devices with up to 6.0 Gb/s data transfer rate.

USB 2.0 Headers  
(9-pin USB\_8\_9)  
(see p.6, No. 16)  
(9-pin USB\_10\_11)  
(see p.6, No. 17)

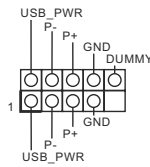

Besides six USB 2.0 ports on the I/O panel, there are two headers on this motherboard. Each USB 2.0 header can support two ports.

USB 3.0 Header  
(19-pin USB3\_2\_3)  
(see p.6, No. 22)

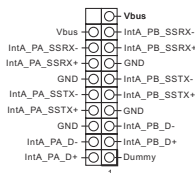

Besides two USB 3.0 ports on the I/O panel, there is one header on this motherboard. This USB 3.0 header can support two ports.

**Front Panel Audio Header**  
 (9-pin HD\_AUDIO1)  
 (see p.6, No. 21)

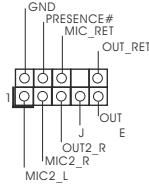

This header is for connecting audio devices to the front audio panel.



1. High Definition Audio supports Jack Sensing, but the panel wire on the chassis must support HDA to function correctly. Please follow the instructions in our manual and chassis manual to install your system.
2. If you use an AC'97 audio panel, please install it to the front panel audio header by the steps below:
  - A. Connect Mic\_IN (MIC) to MIC2\_L.
  - B. Connect Audio\_R (RIN) to OUT2\_R and Audio\_L (LIN) to OUT2\_L.
  - C. Connect Ground (GND) to Ground (GND).
  - D. MIC\_RET and OUT\_RET are for the HD audio panel only. You don't need to connect them for the AC'97 audio panel.
  - E. To activate the front mic, go to the "FrontMic" Tab in the Realtek Control panel and adjust "Recording Volume".

**Chassis Speaker Header**  
 (4-pin SPEAKER1)  
 (see p.6, No. 14)

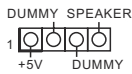

Please connect the chassis speaker to this header.

**Chassis and Power Fan Connectors**  
 (4-pin CHA\_FAN1)  
 (see p.6, No. 23)

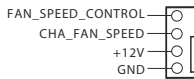

Please connect fan cables to the fan connectors and match the black wire to the ground pin.

(3-pin PWR\_FAN1)  
 (see p.6, No. 6)

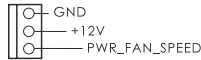

**CPU Fan Connector**  
 (4-pin CPU\_FAN1)  
 (see p.6, No. 2)

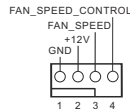

This motherboard provides a 4-Pin CPU fan (Quiet Fan) connector. If you plan to connect a 3-Pin CPU fan, please connect it to Pin 1-3.



ATX Power Connector  
(24-pin ATXPWR1)  
(see p.6, No. 5)

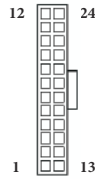

This motherboard provides a 24-pin ATX power connector. To use a 20-pin ATX power supply, please plug it along Pin 1 and Pin 13.

ATX 12V Power Connector  
(8-pin ATX12V2)  
(see p.6, No. 1)

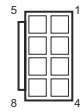

This motherboard provides an 8-pin ATX 12V power connector. To use a 4-pin ATX power supply, please plug it along Pin 1 and Pin 5.

Infrared Module Header  
(5-pin IR1)  
(see p.6, No. 19)

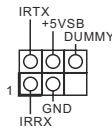

This header supports an optional wireless transmitting and receiving infrared module.

TPM Header  
(17-pin TPMS1)  
(see p.6, No. 20)

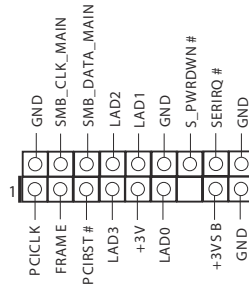

This connector supports Trusted Platform Module (TPM) system, which can securely store keys, digital certificates, passwords, and data. A TPM system also helps enhance network security, protects digital identities, and ensures platform integrity.

## 2.7 CrossFireX™ and Quad CrossFireX™ Operation Guide

This motherboard supports CrossFireX™ and Quad CrossFireX™ that allows you to install up to three identical PCI Express x16 graphics cards. Currently CrossFireX™, 3-way CrossFireX™ and Quad CrossFireX™ are supported with Windows® 7 / 7 64-bit / 8 / 8 64-bit / 8.1 / 8.1 64-bit OS.



1. You should only use identical CrossFireX™-ready graphics cards that are AMD certified.
2. Make sure that your graphics card driver supports AMD CrossFireX™ technology. Download the drivers from the AMD's website: [www.amd.com](http://www.amd.com)
3. Make sure that your power supply unit (PSU) can provide at least the minimum power your system requires. It is recommended to use a AMD certified PSU. Please refer to the AMD's website for details.
4. If you pair a 12-pipe CrossFireX™ Edition card with a 16-pipe card, both cards will operate as 12-pipe cards while in CrossFireX™ mode.
5. Different CrossFireX™ cards may require different methods to enable CrossFireX™. Please refer to AMD graphics card manuals for detailed installation guide.

### 2.7.1 Installing Two CrossFireX™-Ready Graphics Cards

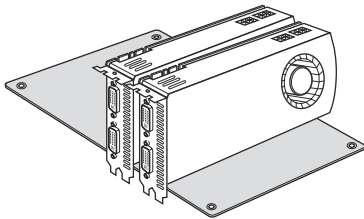

#### Step 1

Insert one graphics card into PCI E2 slot and the other graphics card to PCI E3 slot. Make sure that the cards are properly seated on the slots.



CrossFire Bridge

#### Step 2

Connect two graphics cards by installing a CrossFire Bridge on the CrossFire Bridge Interconnects on the top of the graphics cards. (The CrossFire Bridge is provided with the graphics card you purchase, not bundled with this motherboard. Please refer to your graphics card vendor for details.)

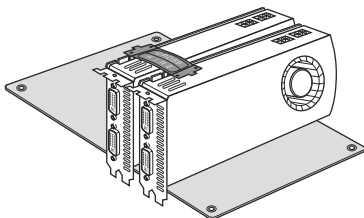

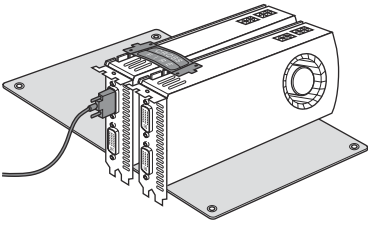
**Step 3**

Connect a VGA cable or a DVI cable to the monitor connector or the DVI connector of the graphics card that is inserted to PCIE2 slot.

## 2.7.2 Driver Installation and Setup

### Step 1

Power on your computer and boot into OS.

### Step 2

Remove the AMD drivers if you have any VGA drivers installed in your system.



*The Catalyst Uninstaller is an optional download. We recommend using this utility to uninstall any previously installed Catalyst drivers prior to installation. Please check AMD's website for AMD driver updates.*

### Step 3

Install the required drivers and CATALYST Control Center then restart your computer. Please check AMD's website for details.



AMD Catalyst Control Center

### Step 4

Double-click the **AMD Catalyst Control Center** icon in the Windows' system tray.

### Step 5

In the left pane, click **Performance** and then **AMD CrossFire™**. Then select **Enable AMD CrossFireX** and click **Apply**. Select the GPU number according to your graphics card and click **Apply**.



## Chapter 3 Software and Utilities Operation

### 3.1 Installing Drivers

The Support CD that comes with the motherboard contains necessary drivers and useful utilities that enhance the motherboard's features.

#### Running The Support CD

To begin using the support CD, insert the CD into your CD-ROM drive. The CD automatically displays the Main Menu if "AUTORUN" is enabled in your computer. If the Main Menu does not appear automatically, locate and double click on the file "ASRSETUP.EXE" in the Support CD to display the menu.

#### Drivers Menu

The drivers compatible to your system will be auto-detected and listed on the support CD driver page. Please click **Install All** or follow the order from top to bottom to install those required drivers. Therefore, the drivers you install can work properly.

#### Utilities Menu

The Utilities Menu shows the application software that the motherboard supports. Click on a specific item then follow the installation wizard to install it.

## 3.2 ASRock EXTREME TUNING UTILITY

ASRock Extreme Tuning Utility (AXTU) is an all-in-one tool to fine-tune different system functions in a user-friendly interface, which is including Hardware Monitor, Fan Control, Overclocking, OC DNA, IES, XFast RAM and Restart to UEFI. In Hardware Monitor, it shows the major readings of your system. In Fan Control, it shows the fan speed and temperature for you to adjust. In Overclocking, you are allowed to overclock CPU frequency for optimal system performance. In OC DNA, you can save your OC settings as a profile and share with your friends. Your friends then can load the OC profile to their own system to get the same OC settings. In IES, you can enjoy the intelligent power saving feature. In XFast RAM, it fully utilizes the memory space that cannot be used under Windows® OS 32-bit CPU. It also shortens the loading time of previously visited websites, making web surfing faster than ever. And it also boosts the speed of Adobe Photoshop 5 times faster. Another advantage is that it reduces the frequency of accessing your SSDs or HDDs in order to extend their lifespan. In Restart to UEFI, it allows users to easily enter the UEFI automatically under Windows® 8 when turning on the PC next time.

### 3.2.1 Installation

When you install all-in-one driver to your system from ASRock support CD, ASRock Extreme Tuning Utility (AXTU) will be auto-installed as well. After installation, you will find the icon “ASRock eXtreme Tuner“ on your desktop. Double-click “ASRock eXtreme Tuner“ icon, AXTU main menu will pop up.



### 3.2.2 Function

Please be noted that there is a button “Auto run when windows start“ on the lower right corner. If you click this button, every time you turn on your system and enter Windows®, the system will automatically start AXTU.

**Auto run when windows start**

There are seven sections in AXTU main menu: Hardware Monitor, Fan Control, Overclocking, OC DNA, IES, XFast RAM and Restart to UEFI.

## Hardware Monitor



In the Hardware Monitor section, it shows the major readings of your system. The main readings include Clock, Fan & Temperature, and Voltage. In Clock, there are CPU speed and CPU ratio. In Fan & Temperature, there are CPU temperature and CPU fan speed. You may find out if there's any abnormal situation occurs to your system's temperature. In Voltage, there are many respective voltages.

## Fan Control



In the Fan Control section, there are two major chapters: Temperature and CPU/Chassis/Power Fan. In Temperature, it shows the major readings of CPU and motherboard temperature. In CPU/Chassis/Power Fan, it shows the fan target speed and temperature, and you are able to adjust the setting by clicking the "+/-" and confirm by "APPLY" afterward.

## Overclocking



In the Overclocking section, there are Clock and Voltage chapters for users to adjust settings and pursuit optimal system performance. You are able to fine-tune the CPU ratio, CPU frequency, and respective voltages by clicking the “+/-” at the display panel. After confirmation of the settings, please click on the “APPLY” button.



*Overclocking and over-voltage may affect your system's stability, or even cause damage to your hardware devices. It should be done at your own risk and expense. We are not responsible for the possible damage caused by overclocking and overvoltage. If system hangs after overclocking, please remove the AC power cord and plug the AC power cord back on again before you power on your system.*

## OC DNA



OC DNA provides a convenient way to record the OC settings and share with others. It helps you to save your overclocking record under the operating system and simplifies the complicated recording process of overclocking settings. With OC DNA, you can save your OC settings as a profile and share with your friends. Your friends then can load the OC profile to their own system to get the same OC settings as yours. Please be noticed that the OC profile can only be shared and worked on the same motherboard.



## IES



Featuring an advanced proprietary hardware and software design, Intelligent Energy Saving is a revolutionary technology that delivers unparalleled power savings. The voltage regulator can reduce the number of output phases to improve efficiency when the CPU cores are idle. In other words, it is able to provide exceptional power saving and improve power efficiency without sacrificing computing performance.

## XFast RAM



XFast RAM fully utilizes the memory space that cannot be used under Windows® OS 32-bit CPU. It also shortens the loading time of previously visited websites, making web surfing faster than ever. And it also boosts the speed of Adobe Photoshop 5 times faster. Another advantage is that it reduces the frequency of accessing your SSDs or HDDs in order to extend their lifespan.

## Restart to UEFI



Windows® 8 brings the ultimate boot up experience. The lightning boot up speed makes it hard to access the UEFI setup. Restart to UEFI technology is designed for those requiring frequent UEFI access. It allows users to easily enter the UEFI automatically when turning on the PC next time. Just simply enable this function; the PC will be assured to access the UEFI directly in the very beginning.

### 3.3 ASRock APP Shop

The ASRock APP Shop is an online store for purchasing and downloading software applications for your ASRock computer. You can install various apps and support utilities quickly and easily, and optimize your system and keep your motherboard up to date simply with a few clicks.

Double-click  on your desktop to access ASRock APP Shop utility.

*\*You need to be connected to the Internet to download apps from the ASRock APP Shop.*

#### 3.3.1 UI Overview

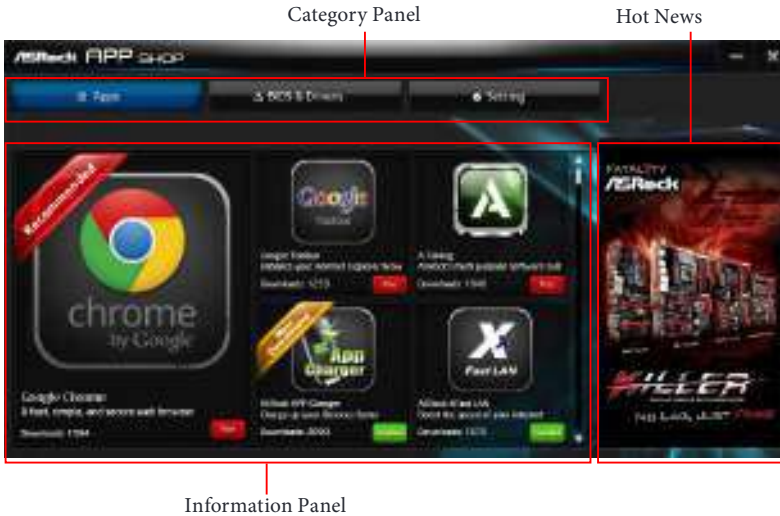

**Category Panel:** The category panel contains several category tabs or buttons that when selected the information panel below displays the relative information.

**Information Panel:** The information panel in the center displays data about the currently selected category and allows users to perform job-related tasks.

**Hot News:** The hot news section displays the various latest news. Click on the image to visit the website of the selected news and know more.

## 3.3.2 Apps

When the "Apps" tab is selected, you will see all the available apps on screen for you to download.

### Installing an App

#### Step 1

Find the app you want to install.



The most recommended app appears on the left side of the screen. The other various apps are shown on the right. Please scroll up and down to see more apps listed.

You can check the price of the app and whether you have already installed it or not.

**Free** - The red icon displays the price or "Free" if the app is free of charge.

**Installed** - The green "Installed" icon means the app is installed on your computer.

#### Step 2

Click on the app icon to see more details about the selected app.

**Step 3**

If you want to install the app, click on the red icon  to start downloading.

**Step 4**

When installation completes, you can find the green "Installed" icon appears on the upper right corner.



To uninstall it, simply click on the trash can icon  .  
\*The trash icon may not appear for certain apps.

## Upgrading an App

You can only upgrade the apps you have already installed. When there is an available new version for your app, you will find the mark of "New Version"  appears below the installed app icon.



### Step 1

Click on the app icon to see more details.

### Step 2

Click on the yellow icon  to start upgrading.

### 3.3.3 BIOS & Drivers

#### Installing BIOS or Drivers

When the "BIOS & Drivers" tab is selected, you will see a list of recommended or critical updates for the BIOS or drivers. Please update them all soon.



#### **Step 1**

Please check the item information before update. Click on  to see more details.

#### **Step 2**

Click to select one or more items you want to update.

#### **Step 3**

Click Update to start the update process.

### 3.3.4 Setting

In the "Setting" page, you can change the language, select the server location, and determine if you want to automatically run the ASRock APP Shop on Windows startup.





## 3.4 Start8

For those Windows 8 users who miss the Start Menu, Start8 is an ideal solution that brings back the familiar Start Menu along with added customizations for greater efficiency.

### 3.4.1 Installing Start8

Install **Start8**, which is located in the folder at the following path of the Support CD:  
\**ASRock Utility** > **Start8**.

### 3.4.2 Configuring Start8

Style

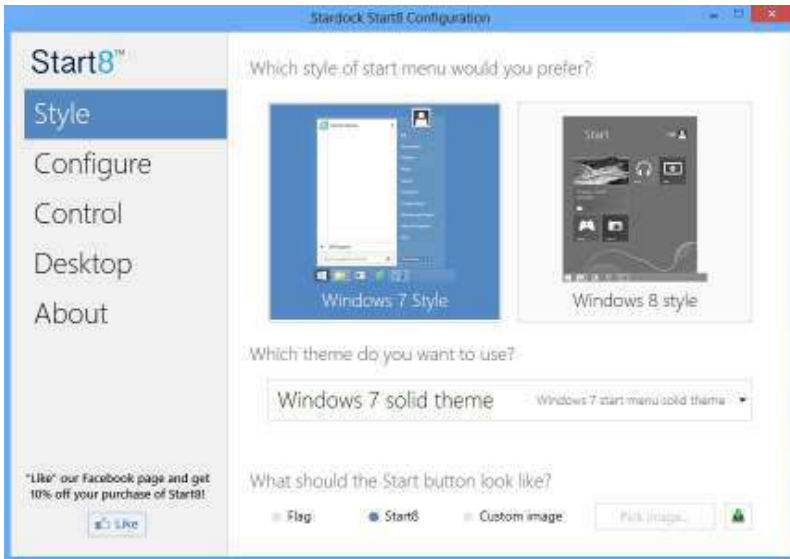

Select between the Windows 7 style and Windows 8 style Start Menu. Then select the theme of the Start Menu and customize the style of the Start icon.

## Configure

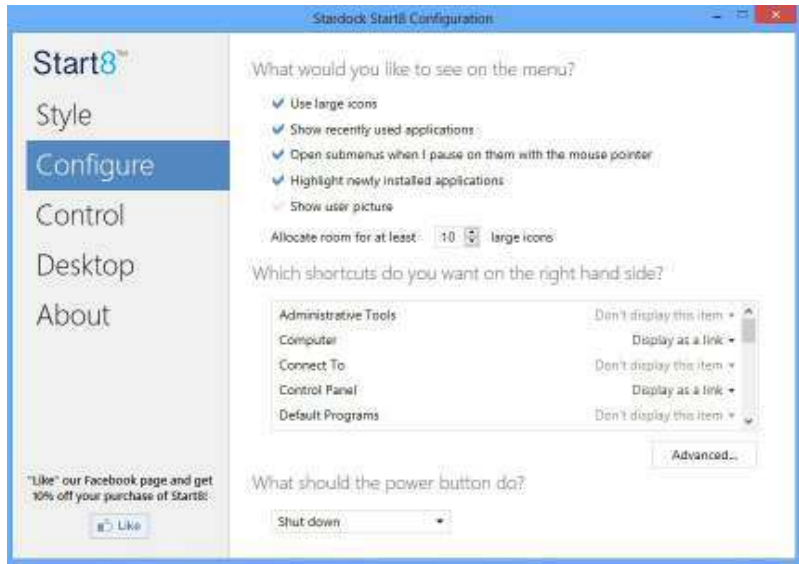

**Configure** provides configuration options, including icon sizes, which shortcuts you want Start Menu to display, quick access to recently used apps, the functionality of the power button, and more.

## Control

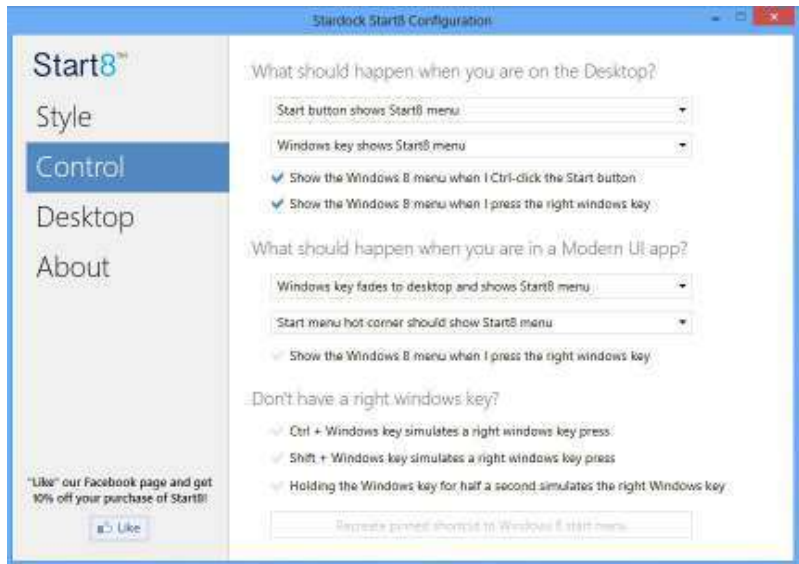

Control lets you configure what a click on the start button or a press on the Windows key does.

## Desktop

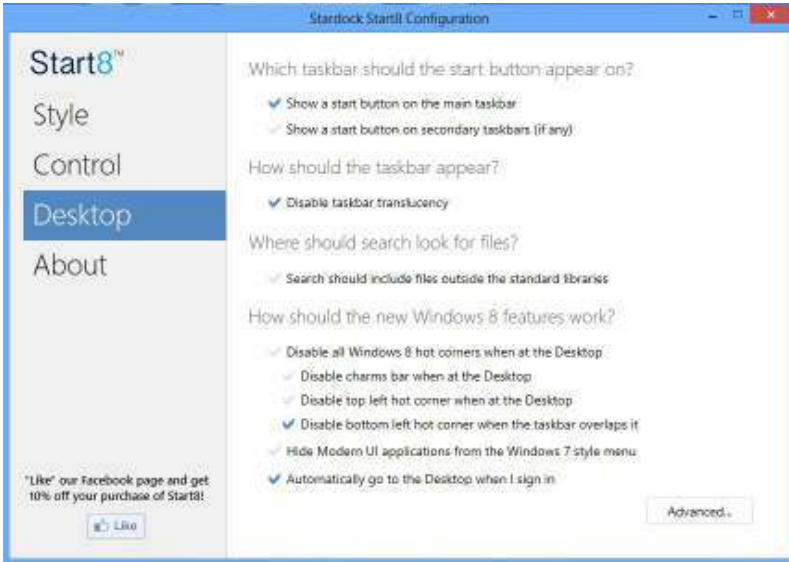

Desktop allows you to disable the hot corners when you are working on the desktop. It also lets you choose whether or not the system boots directly into desktop mode and bypass the Metro user interface.

## About

Displays information about Start8.

# Chapter 4 UEFI SETUP UTILITY

## 4.1 Introduction

This section explains how to use the UEFI SETUP UTILITY to configure your system. You may run the UEFI SETUP UTILITY by pressing <F2> or <Del> right after you power on the computer, otherwise, the Power-On-Self-Test (POST) will continue with its test routines. If you wish to enter the UEFI SETUP UTILITY after POST, restart the system by pressing <Ctl> + <Alt> + <Delete>, or by pressing the reset button on the system chassis. You may also restart by turning the system off and then back on.



*Because the UEFI software is constantly being updated, the following UEFI setup screens and descriptions are for reference purpose only, and they may not exactly match what you see on your screen.*

### 4.1.1 UEFI Menu Bar

The top of the screen has a menu bar with the following selections:

<b>Main</b>	For setting system time/date information
<b>OC Tweaker</b>	For overclocking configurations
<b>Advanced</b>	For advanced system configurations
<b>Tool</b>	Useful tools
<b>H/W Monitor</b>	Displays current hardware status
<b>Boot</b>	For configuring boot settings and boot priority
<b>Security</b>	For security settings
<b>Exit</b>	Exit the current screen or the UEFI Setup Utility

## 4.1.2 Navigation Keys

Use <←→> key or <→> key to choose among the selections on the menu bar, and use <↑> key or <↓> key to move the cursor up or down to select items, then press <Enter> to get into the sub screen. You can also use the mouse to click your required item.

Please check the following table for the descriptions of each navigation key.

Navigation Key(s)	Description
+ / -	To change option for the selected items
<Tab>	Switch to next function
<PGUP>	Go to the previous page
<PGDN>	Go to the next page
<HOME>	Go to the top of the screen
<END>	Go to the bottom of the screen
<F1>	To display the General Help Screen
<F7>	Discard changes and exit the SETUP UTILITY
<F9>	Load optimal default values for all the settings
<F10>	Save changes and exit the SETUP UTILITY
<F12>	Print screen
<ESC>	Jump to the Exit Screen or exit the current screen

## 4.2 Main Screen

When you enter the UEFI SETUP UTILITY, the Main screen will appear and display the system overview.



### Active Page on Entry

Select the default page when entering the UEFI setup utility.



## Spread Spectrum

This item should always be [Auto] for better system stability.

## CPU Active Core Control

This allows you to adjust CPU Active Core Control feature. The configuration options depend on the CPU core you adopt. The default value is [Disabled].

## AMD Turbo Core Technology

This item appears only when the processor you adopt supports this feature. Use this to select enable or disable AMD Turbo Core Technology. Configuration options: [Enabled] and [Disabled]. The default value is [Enabled].

## AMD Application Power Management

Application Power Management (APM) ensures that average power consumption over a thermally significant time period remains at or below the TDP for the CPU mode being used. If [Enabled] is selected, the power consumption is reduced when overclocking.

## Multiplier/Voltage Change

This item is set to [Auto] by default. If it is set to [Manual], you may adjust the value of Processor Frequency and Processor Voltage. However, it is recommended to keep the default value for system stability.

## HT Bus Speed

This feature allows you selecting Hyper-Transport bus speed. Configuration options: [200MHz] to [2000MHz].

## HT Bus Width

This feature allows you selecting Hyper-Transport bus width. Configuration options: [8 Bit] and [16 Bit].

## DRAM Timing Configuration

### Load Profile Setting

Select the Intel® Extreme Memory Profile (X.M.P.).

### DRAM Frequency

If [Auto] is selected, the motherboard will detect the memory module(s) inserted and assign the appropriate frequency automatically.



## DRAM Timing Control



## DRAM Slot

Use this item to view SPD data.

## DRAM Timing Control

Use this item to control DRAM timing.

## Power Down Enable

Use this item to enable or disable DDR power down mode.

## Bank Interleaving

Interleaving allows memory accesses to be spread out over banks on the same node, or across nodes, decreasing access contention.

## Channel Interleaving

It allows you to enable Channel Memory Interleaving. Configuration options: [Disabled], [Auto]. The default value is [Auto].

## Voltage Configuration

### DRAM Voltage

Use this to select DRAM Voltage. The default value is [Auto].

---

## CPU Voltage Offset

Configure the dynamic CPU voltage added to the CPU.

## NB Voltage

Use this to select NB Voltage. The default value is [Auto].

## HT Voltage

Use this to select HT Voltage. The default value is [Auto].

## 4.4 Advanced Screen

In this section, you may set the configurations for the following items: CPU Configuration, North Bridge Configuration, South Bridge Configuration, Storage Configuration, Super IO Configuration, ACPI Configuration, USB Configuration and Trusted Computing.



*Setting wrong values in this section may cause the system to malfunction.*

## 4.4.1 CPU Configuration



### Cool 'n' Quiet

Use this item to enable or disable AMD's Cool 'n' Quiet™ technology. The default value is [Enabled]. Configuration options: [Enabled] and [Disabled]. If you install Windows® 8.1 / 8 / 7 and want to enable this function, please set this item to [Enabled]. Please note that enabling this function may reduce CPU voltage and memory frequency, and lead to system stability or compatibility issue with some memory modules or power supplies. Please set this item to [Disable] if above issue occurs.

### Enhance Halt State (C1E)

All processors support the Halt State (C1). The C1 state is supported through the native processor instructions HLT and MWAIT and requires no hardware support from the chipset. In the C1 power state, the processor maintains the context of the system caches.

### Secure Virtual Machine

When this option is set to [Enabled], a VMM (Virtual Machine Architecture) can utilize the additional hardware capabilities provided by AMD-V. The default value is [Enabled]. Configuration options: [Enabled] and [Disabled].

### Core C6 Mode

Use this item to enable or disable Core C6 mode. The default value is [Enabled].

## CPU Thermal Throttle

Use this item to enable CPU internal thermal control mechanism to keep the CPU from overheated. The default value is [Auto].

## 4.4.2 North Bridge Configuration



### Primary Graphics Adapter

Select a primary VGA.

### IOMMU

Use this to enable or disable IOMMU. The default value of this feature is [Disabled].

### 4.4.3 South Bridge Configuration



#### Onboard HD Audio

Enable/disable onboard HD audio. Set to Auto to enable onboard HD audio and automatically disable it when a sound card is installed.

#### Front Panel

Enable/disable front panel HD audio.

#### On/Off Play

With ASRock On/Off Play users can connect their portable audio devices, such as an MP3 player or a mobile phone to the PC and listen to music through the computer's speakers even when the computer is turned off.

#### Onboard LAN

Enable or disable the onboard network interface controller.

#### Good Night LED

By enabling Good Night LED, the Power/HDD LEDs will be switched off when the system is on. It will also automatically switch off the Power and Keyboard LEDs when the system enters into Standby/Hibernation mode.

## 4.4.4 Storage Configuration



### SATA Controller(s)

Enable/disable the SATA controllers.

### SATA Mode

IDE: For better compatibility.

AHCI: Supports new features that improve performance.

RAID: Combine multiple disk drives into a logical unit.



*If you set this item to RAID mode, it is suggested to install SATA ODD driver on SATA3\_5 or SATA3\_6 port.*

### AMD AHCI BIOS ROM

Use this item to enable or disable AMD AHCI BIOS ROM. The default value of this option is [Disabled].

### SATA IDE Combined Mode

This item is for SATA3\_5 and SATA3\_6 ports. Use this item to enable or disable SATA IDE combined mode. The default value is [Enabled].





*If you want to build RAID on SATA3\_5 and SATA3\_6 ports, please disable this item.*

## Aggressive Link Power Management

Aggressive Link Power Management allows SATA devices to enter a low power state during periods of inactivity to save power. It is only supported by AHCI mode.

## Hard Disk S.M.A.R.T.

S.M.A.R.T stands for Self-Monitoring, Analysis, and Reporting Technology. It is a monitoring system for computer hard disk drives to detect and report on various indicators of reliability.

## 4.4.5 Super IO Configuration



### Serial Port

Enable or disable the Serial port.

### Serial Port Address

Select the address of the Serial port.

### Infrared Port

Enable or disable the Infrared port.

## 4.4.6 ACPI Configuration



### Suspend to RAM

Select disable for ACPI suspend type S1. It is recommended to select auto for ACPI S3 power saving.

### Check Ready Bit

Enable to enter the operating system after S3 only when the hard disk is ready, this is recommended for better system stability.

### ACPI HPET Table

Enable the High Precision Event Timer for better performance and to pass WHQL tests.

### Restore on AC/Power Loss

Select the power state after a power failure. If [Power Off] is selected, the power will remain off when the power recovers. If [Power On] is selected, the system will start to boot up when the power recovers.

### PS/2 Keyboard Power On

Allow the system to be waked up by a PS/2 Keyboard.

### PCIE Devices Power On

Allow the system to be waked up by a PCIE device and enable wake on LAN.

---

### Ring-In Power On

Allow the system to be waked up by onboard COM port modem Ring-In signals.

### RTC Alarm Power On

Allow the system to be waked up by the real time clock alarm. Set it to By OS to let it be handled by your operating system.

### USB Keyboard/Remote Power On

Allow the system to be waked up by an USB keyboard or remote controller.

### USB Mouse Power On

Allow the system to be waked up by an USB mouse.

## 4.4.7 USB Configuration



### USB Controller

Enable or disable all the USB 2.0 ports.

### USB 3.0 Controller

Enable or disable all the USB 3.0 ports.

### Legacy USB Support

Enable or disable Legacy OS Support for USB 2.0 devices. If you encounter USB compatibility issues it is recommended to disable legacy USB support. Select UEFI Setup Only to support USB devices under the UEFI setup and Windows/Linux operating systems only.

### Legacy USB 3.0 Support

Enable or disable Legacy OS Support for USB 3.0 devices.

## 4.4.8 Trusted Computing



### Security Device Support

Enable to activate Trusted Platform Module (TPM) security for your hard disk drives.

## 4.5 Tools



### System Browser

ASRock System Browser shows the overview of your current PC and the devices connected.

### OMG (Online Management Guard)

Administrators are able to establish an internet curfew or restrict internet access at specified times via OMG. You may schedule the starting and ending hours of internet access granted to other users. In order to prevent users from bypassing OMG, guest accounts without permission to modify the system time are required.

### UEFI Tech Service

Contact ASRock Tech Service if you are having trouble with your PC. Please setup network configuration before using UEFI Tech Service.

### Easy RAID Installer

Easy RAID Installer helps you to copy the RAID driver from the support CD to your USB storage device. After copying the drivers please change the SATA mode to RAID, then you can start installing the operating system in RAID mode.

### Easy Driver Installer

For users that don't have an optical disk drive to install the drivers from our support CD, Easy Driver Installer is a handy tool in the UEFI that installs the LAN driver to your system via an USB storage device, then downloads and installs the other

required drivers automatically.

## Instant Flash

Save UEFI files in your USB storage device and run Instant Flash to update your UEFI.

## Internet Flash

ASRock Internet Flash downloads and updates the latest UEFI firmware version from our servers for you. Please setup network configuration before using Internet Flash.

\*For BIOS backup and recovery purpose, it is recommended to plug in your USB pen drive before using this function.

## Network Configuration

Use this to configure internet connection settings for Internet Flash.



## Internet Setting

Enable or disable sound effects in the setup utility.

## UEFI Download Server

Select a server to download the UEFI firmware.



## Dehumidifier Function

If Dehumidifier Function is enabled, the computer will power on automatically to dehumidify the system after entering S4/S5 state.

## Dehumidifier Period

Configure the period of time until the computer powers on and enables Dehumidifier after entering S4/S5 state.

## Dehumidifier Duration

Configure the duration of the dehumidifying process before it returns to S4/S5 state.

## Dehumidifier CPU Fan Setting

Configure the speed of the CPU fan while Dehumidifier is enabled. The higher the value, the faster the fan speed.

Max: 255

Min: 1

## Save User Default

Type a profile name and press enter to save your settings as user default.

## Load User Default

Load previously saved user defaults.

## 4.6 Hardware Health Event Monitoring Screen

This section allows you to monitor the status of the hardware on your system, including the parameters of the CPU temperature, motherboard temperature, fan speed and voltage.



### CPU Fan 1 Setting

This allows you to set the CPU fan 1 speed. Configuration options: [Full On] and [Automatic Mode]. The default is value [Full On].

### Chassis Fan 1 Setting

This allows you to set the chassis fan 1 speed. Configuration options: [Full On] and [Automatic Mode]. The default is value [Full On].

### Over Temperature Protection

When Over Temperature Protection is enabled, the system automatically shuts down when the motherboard is overheated.

## 4.7 Boot Screen

This section displays the available devices on your system for you to configure the boot settings and the boot priority.



### Fast Boot

Fast Boot minimizes your computer's boot time. In fast mode you may not boot from an USB storage device. Ultra Fast mode is only supported by Windows 8.1 / 8 and the VBIOS must support UEFI GOP if you are using an external graphics card. Please notice that Ultra Fast mode will boot so fast that the only way to enter this UEFI Setup Utility is to Clear CMOS or run the Restart to UEFI utility in Windows.

### Boot From Onboard LAN

Allow the system to be waked up by the onboard LAN.

### Setup Prompt Timeout

Configure the number of seconds to wait for the setup hot key.

### Bootup Num-Lock

Select whether Num Lock should be turned on or off when the system boots up.

### Full Screen Logo

Enable to display the boot logo or disable to show normal POST messages.

---

### **AddOn ROM Display**

Enable AddOn ROM Display to see the AddOn ROM messages or configure the AddOn ROM if you've enabled Full Screen Logo. Disable for faster boot speed.

### **Boot Failure Guard**

If the computer fails to boot for a number of times the system automatically restores the default settings.

### **Boot Failure Guard Count**

Configure the number of attempts to boot until the system automatically restores the default settings.

## CSM (Compatibility Support Module)



### CSM

Enable to launch the Compatibility Support Module. Please do not disable unless you're running a WHCK test. If you are using Windows 8.1 / 8 64-bit and all of your devices support UEFI, you may also disable CSM for faster boot speed.

### Launch PXE OpROM Policy

Select UEFI only to run those that support UEFI option ROM only. Select Legacy only to run those that support legacy option ROM only. Do not launch?

### Launch Storage OpROM Policy

Select UEFI only to run those that support UEFI option ROM only. Select Legacy only to run those that support legacy option ROM only. Do not launch?

### Launch Video OpROM Policy

Select UEFI only to run those that support UEFI option ROM only. Select Legacy only to run those that support legacy option ROM only. Do not launch?

## 4.8 Security Screen

In this section you may set or change the supervisor/user password for the system. You may also clear the user password.



### Supervisor Password

Set or change the password for the administrator account. Only the administrator has authority to change the settings in the UEFI Setup Utility. Leave it blank and press enter to remove the password.

### User Password

Set or change the password for the user account. Users are unable to change the settings in the UEFI Setup Utility. Leave it blank and press enter to remove the password.

### Secure Boot

Enable to support Windows 8.1 / 8 Secure Boot.

## 4.9 Exit Screen



### Save Changes and Exit

When you select this option the following message, “Save configuration changes and exit setup?” will pop out. Select [OK] to save changes and exit the UEFI SETUP UTILITY.

### Discard Changes and Exit

When you select this option the following message, “Discard changes and exit setup?” will pop out. Select [OK] to exit the UEFI SETUP UTILITY without saving any changes.

### Discard Changes

When you select this option the following message, “Discard changes?” will pop out. Select [OK] to discard all changes.

### Load UEFI Defaults

Load UEFI default values for all options. The F9 key can be used for this operation.

## Contact Information

If you need to contact ASRock or want to know more about ASRock, you're welcome to visit ASRock's website at <http://www.asrock.com>; or you may contact your dealer for further information. For technical questions, please submit a support request form at <http://www.asrock.com/support/tsd.asp>

### **ASRock Incorporation**

2F., No.37, Sec. 2, Jhongyang S. Rd., Beitou District,  
Taipei City 112, Taiwan (R.O.C.)

### **ASRock EUROPE B.V.**

Bijsterhuizen 3151

6604 LV Wijchen

The Netherlands

Phone: +31-24-345-44-33

Fax: +31-24-345-44-38

### **ASRock America, Inc.**

13848 Magnolia Ave, Chino, CA91710

U.S.A.

Phone: +1-909-590-8308

Fax: +1-909-590-1026