



B150TM-ITX TPM R2.0

User Manual

Version 1.0

Published August 2017

Copyright©2017 ASRock INC. All rights reserved.

Version 1.0

Published August 2017

Copyright©2017 ASRock INC. All rights reserved.

Copyright Notice:

No part of this documentation may be reproduced, transcribed, transmitted, or translated in any language, in any form or by any means, except duplication of documentation by the purchaser for backup purpose, without written consent of ASRock Inc.

Products and corporate names appearing in this documentation may or may not be registered trademarks or copyrights of their respective companies, and are used only for identification or explanation and to the owners' benefit, without intent to infringe.

Disclaimer:

Specifications and information contained in this documentation are furnished for informational use only and subject to change without notice, and should not be constructed as a commitment by ASRock. ASRock assumes no responsibility for any errors or omissions that may appear in this documentation.

With respect to the contents of this documentation, ASRock does not provide warranty of any kind, either expressed or implied, including but not limited to the implied warranties or conditions of merchantability or fitness for a particular purpose.

In no event shall ASRock, its directors, officers, employees, or agents be liable for any indirect, special, incidental, or consequential damages (including damages for loss of profits, loss of business, loss of data, interruption of business and the like), even if ASRock has been advised of the possibility of such damages arising from any defect or error in the documentation or product.



This device complies with Part 15 of the FCC Rules. Operation is subject to the following two conditions:

- (1) this device may not cause harmful interference, and
- (2) this device must accept any interference received, including interference that may cause undesired operation.

CALIFORNIA, USA ONLY

The Lithium battery adopted on this motherboard contains Perchlorate, a toxic substance controlled in Perchlorate Best Management Practices (BMP) regulations passed by the California Legislature. When you discard the Lithium battery in California, USA, please follow the related regulations in advance.

“Perchlorate Material-special handling may apply, see www.dtsc.ca.gov/hazardouswaste/perchlorate”

ASRock Website: <http://www.asrock.com>

AUSTRALIA ONLY

Our goods come with guarantees that cannot be excluded under the Australian Consumer Law. You are entitled to a replacement or refund for a major failure and compensation for any other reasonably foreseeable loss or damage caused by our goods. You are also entitled to have the goods repaired or replaced if the goods fail to be of acceptable quality and the failure does not amount to a major failure. If you require assistance please call ASRock Tel : +886-2-28965588 ext.123 (Standard International call charges apply)

The terms HDMI™ and HDMI High-Definition Multimedia Interface, and the HDMI logo are trademarks or registered trademarks of HDMI Licensing LLC in the United States and other countries.



Contents

Chapter 1 Introduction	1
1.1 Package Contents	1
1.2 Specifications	2
1.3 Motherboard Layout	6
1.4 I/O Panel	8
Chapter 2 Installation	9
2.1 Installing the CPU	10
2.2 Installing the CPU Fan and Heatsink	13
2.3 Installing Memory Modules (SO-DIMM)	14
2.4 Jumpers Setup	15
2.5 Onboard Headers and Connectors	16
2.6 M.2 WiFi/BT Module Installation Guide	22
Chapter 3 Software and Utilities Operation	24
3.1 Installing Drivers	24
3.2 ASRock Live Update & APP Shop	25
3.2.1 UI Overview	25
3.2.2 Apps	26
3.2.3 BIOS & Drivers	29
3.2.4 Setting	30
3.3 Enabling USB Ports for Windows® 7 Installation	31
Chapter 4 UEFI SETUP UTILITY	34
4.1 Introduction	34

4.2	EZ Mode	35
4.3	Advanced Mode	36
4.3.1	UEFI Menu Bar	36
4.3.2	Navigation Keys	37
4.4	Main Screen	38
4.5	OC Tweaker Screen	39
4.6	Advanced Screen	46
4.6.1	CPU Configuration	47
4.6.2	Chipset Configuration	49
4.6.3	Storage Configuration	51
4.6.4	Super IO Configuration	52
4.6.5	ACPI Configuration	53
4.6.6	USB Configuration	54
4.7	Tools	55
4.8	Hardware Health Event Monitoring Screen	58
4.9	Security Screen	59
4.10	Boot Screen	60
4.11	Exit Screen	63

Chapter 1 Introduction

Thank you for purchasing ASRock B150TM-ITX TPM R2.0 motherboard, a reliable motherboard produced under ASRock's consistently stringent quality control. It delivers excellent performance with robust design conforming to ASRock's commitment to quality and endurance.

In this documentation, Chapter 1 and 2 contains the introduction of the motherboard and step-by-step installation guides. Chapter 3 contains the operation guide of the software and utilities. Chapter 4 contains the configuration guide of the BIOS setup.



Because the motherboard specifications and the BIOS software might be updated, the content of this documentation will be subject to change without notice. In case any modifications of this documentation occur, the updated version will be available on ASRock's website without further notice. If you require technical support related to this motherboard, please visit our website for specific information about the model you are using. You may find the latest VGA cards and CPU support list on ASRock's website as well. ASRock website <http://www.asrock.com>.

1.1 Package Contents

- ASRock B150TM-ITX TPM R2.0 Motherboard (Thin Mini-ITX Form Factor)
- ASRock B150TM-ITX TPM R2.0 Quick Installation Guide
- ASRock B150TM-ITX TPM R2.0 Support CD
- 2 x Serial ATA (SATA) Data Cables (Optional)
- 1 x SATA 1 to 2 Power Cable (Optional)
- 2 x I/O Panel Shields
- 2 x Screws for M.2 Sockets

1.2 Specifications

- Platform**
- Thin Mini-ITX Form Factor (Compatible with Mini-ITX)
 - Solid Capacitor design

- CPU**
- Supports 7th and 6th Generation Intel® Core™ i7/i5/i3/Pentium®/Celeron® Processors (Socket 1151)
 - Supports CPU up to 65W
 - Digi Power design
 - 5 Power Phase design
 - Supports Intel® Turbo Boost 2.0 Technology

- Chipset**
- Intel® B150

- Memory**
- Dual Channel DDR4 Memory Technology
 - 2 x DDR4 SO-DIMM Slots
 - Supports DDR4 2133 non-ECC, un-buffered memory
 - Supports ECC SO-DIMM memory modules (operate in non-ECC mode)
 - Max. capacity of system memory: 32GB
 - Supports Intel® Extreme Memory Profile (XMP) 2.0

- Expansion Slot**
- 1 x M.2 Socket (Key E), supports type 2230 WiFi/BT module

- Graphics**
- Intel® HD Graphics Built-in Visuals and the VGA outputs can be supported only with processors which are GPU integrated.
 - Supports Intel® HD Graphics Built-in Visuals : Intel® Quick Sync Video with AVC, MVC (S3D) and MPEG-2 Full HW Encode1, Intel® InTru™ 3D, Intel® Clear Video HD Technology, Intel® Insider™, Intel® HD Graphics 510/530
 - Pixel Shader 5.0, DirectX 12
 - Max. shared memory 1024MB
- * The size of maximum shared memory may vary from different operating systems.
- Four graphics output options: D-Sub, HDMI, DisplayPort 1.2 and LVDS
 - Supports Triple Monitor

- Supports HDMI with max. resolution up to 4K x 2K (4096x2160) @ 24Hz / (3840x2160) @ 30Hz
- Supports D-Sub with max. resolution up to 1920x1200 @ 60Hz
- Supports DisplayPort 1.2 with max. resolution up to 4K x 2K (4096x2304) @ 60Hz
- Supports LVDS with max. resolution up to 1920x1200 @ 60Hz
- Supports Auto Lip Sync, Deep Color (12bpc), xvYCC and HBR (High Bit Rate Audio) with HDMI Port (Compliant HDMI monitor is required)
- Supports Accelerated Media Codecs: HEVC, VP8, VP9
- Supports HDCP with HDMI and DisplayPort 1.2 Ports
- Supports Full HD 1080p Blu-ray (BD) playback with HDMI and DisplayPort 1.2 Ports

Audio

- 7.1 CH HD Audio with Content Protection (Realtek ALC892 Audio Codec)

* To configure 7.1 CH HD Audio, it is required to use an HD front panel audio module and enable the multi-channel audio feature through the audio driver.

- Premium Blu-ray Audio support
- Supports Surge Protection (ASRock Full Spike Protection)
- ELNA Audio Caps

LAN

- PCIE x1 Gigabit LAN 10/100/1000 Mb/s
- Realtek RTL8111EP
- Supports Wake-On-LAN
- Supports Lightning/ESD Protection (ASRock Full Spike Protection)
- Supports LAN Cable Detection
- Supports Energy Efficient Ethernet 802.3az
- Supports PXE
- Supports DASH

Rear Panel I/O

- 1 x DC Jack (Compatible with the 19V power adapter)
- 1 x D-Sub Port
- 1 x HDMI Port
- 1 x DisplayPort 1.2

- 4 x USB 3.1 Gen1 Ports (Supports ESD Protection (ASRock Full Spike Protection))
- 1 x RJ-45 LAN Port with LED (ACT/LINK LED and SPEED LED)
- HD Audio Jacks: Front Speaker / Microphone

Storage

- 2 x SATA3 6.0 Gb/s Connectors, support NCQ, AHCI and Hot Plug
 - 1 x Ultra M.2 Socket, supports M Key type 2242/2260/2280 M.2 SATA3 6.0 Gb/s module and M.2 PCI Express module up to Gen3 x4 (32 Gb/s)*
- * M2_2: RST utility port0; SATA3_0: RST utility port2;
SATA3_1: RST utility port3

Connector

- 1 x Onboard TPM 2.0 (Infineon)
 - 1 x CIR Header
 - 1 x COM Port Header
 - 1 x SPDIF Out Connector
 - 1 x Monitor Switch Header
 - 1 x Backlight Power Jumper
 - 1 x Panel Power Jumper
 - 1 x Backlight Control Header
 - 1 x LVDS Connector
 - 1 x Home Theater PC Header
 - 1 x CPU Fan Connector (4-pin)
 - 1 x Chassis Fan Connector (4-pin) (Smart Fan Speed Control)
- * The CPU Fan Connector supports the CPU fan of maximum 1A (12W) fan power.
- 1 x Front Panel Audio Connector
 - 1 x Analog Surround Audio Header
 - 1 x Digital MIC Header
 - 1 x 3W Audio AMP Output Wafer Header
 - 1 x Internal Power Header
 - 1 x SATA Power Connector
 - 3 x USB 2.0 Headers (Support 5 USB 2.0 ports) (Supports ESD Protection (ASRock Full Spike Protection))
 - 1 x USB 3.1 Gen1 Header (Supports 2 USB 3.1 Gen1 ports) (Supports ESD Protection (ASRock Full Spike Protection))

- BIOS Feature**
- AMI UEFI Legal BIOS with multilingual GUI support
 - ACPI 5.0 Compliant wake up events
 - SMBIOS 2.7 Support
 - DRAM Voltage Multi-adjustment

- Hardware Monitor**
- CPU/Chassis temperature sensing
 - CPU/Chassis Fan Tachometer
 - CPU/Chassis Quiet Fan (Auto adjust chassis fan speed by CPU temperature)
 - CPU/Chassis Fan multi-speed control
 - Voltage monitoring: +12V, +5V, +3.3V, CPU Vcore

- OS**
- Microsoft® Windows® 10 64-bit / 8.1 64-bit / 7 32-bit / 7 64-bit
- * To install Windows® 7 OS, a modified installation disk with xHCI drivers packed into the ISO file is required. Please refer to page 31 or more detailed instructions.
- * For the updated Windows® 10 driver, please visit ASRock's website for details: <http://www.asrock.com>

- Certifications**
- FCC, CE, WHQL
 - ErP/EuP Ready (ErP/EuP ready power supply is required)

* For detailed product information, please visit our website: <http://www.asrock.com>



Please realize that there is a certain risk involved with overclocking, including adjusting the setting in the BIOS, applying Untied Overclocking Technology, or using third-party overclocking tools. Overclocking may affect your system's stability, or even cause damage to the components and devices of your system. It should be done at your own risk and expense. We are not responsible for possible damage caused by overclocking.

1.3 Motherboard Layout

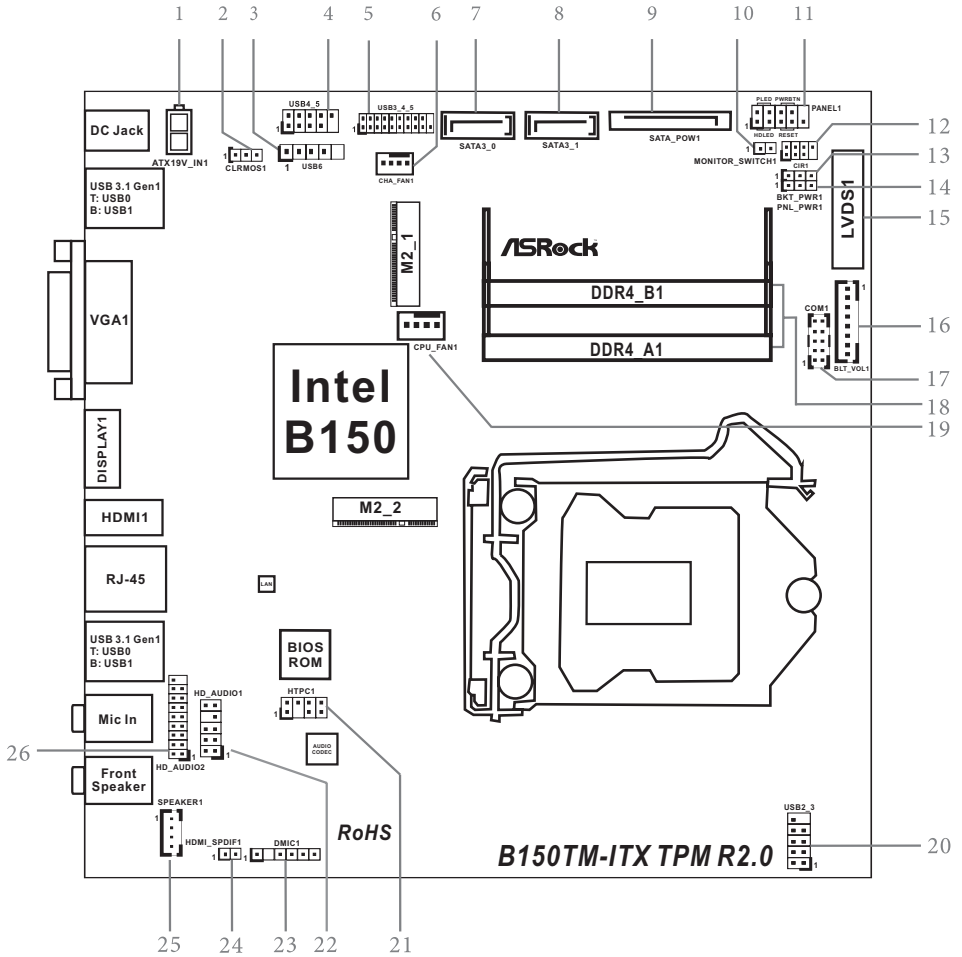

No.	Description
1	Internal Power Header (ATX19V_IN1)
2	Clear CMOS Jumper (CLRMOS1)
3	USB 2.0 Header (USB6)
4	USB 2.0 Header (USB4_5)
5	USB 3.1 Gen1 Header (USB3_4_5)
6	Chassis Fan Connector (CHA_FAN1)
7	SATA3 Connector (SATA3_0)
8	SATA3 Connector (SATA3_1)
9	SATA Power Connector (SATA_POW1)
10	Monitor Switch Header (MONITOR_SWITCH1)
11	System Panel Header (PANEL1)
12	Consumer Infrared Module Header (CIR1)
13	Backlight Power Jumper (BKT_PWR1)
14	Panel Power Jumper (PNL_PWR1)
15	LVDS Connector (LVDS1)
16	Backlight Control Header (BLT_VOL1)
17	COM Port Header (COM1)
18	2 x 260-pin DDR4 SO-DIMM Slots (DDR4_A1, DDR4_B1)
19	CPU Fan Connector (CPU_FAN1)
20	USB 2.0 Header (USB2_3)
21	Home Theater PC Header (HTPC1)
22	Front Panel Audio Header (HD_AUDIO1)
23	Digital MIC Header (DMIC1)
24	SPDIF Out Connector (HDMI_SPDIF1)
25	3W Audio AMP Output Wafer Header (SPEAKER1)
26	Analog Surround Audio Header (HD_AUDIO2)

1.4 I/O Panel

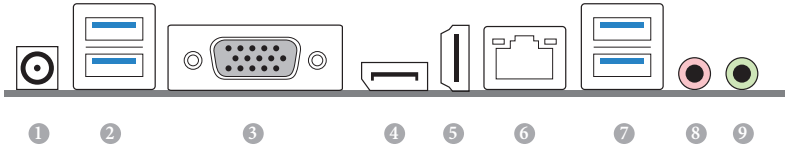

No.	Description	No.	Description
1	DC Jack**	6	LAN RJ-45 Port*
2	USB 3.1 Gen1 Ports (USB3_01)	7	USB 3.1 Gen1 Ports (USB01)
3	D-Sub Port (VGA1)	8	Microphone (Pink)
4	DisplayPort 1.2 (DISPLAY1)	9	Front Speaker (Lime)
5	HDMI Port (HDMI1)		

* There are two LEDs on each LAN port. Please refer to the table below for the LAN port LED indications.

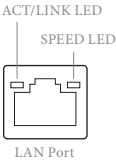

Activity / Link LED		Speed LED	
Status	Description	Status	Description
Off	No Link	Off	10Mbps connection
Blinking	Data Activity	Orange	100Mbps connection
On	Link	Green	1Gbps connection

** Please use a 19V power adapter for the DC jack. This jack accepts dual barrel plugs with an inner diameter of 5.1 mm and an outer diameter of 7.4 mm, where the inner contact is +19 (±10%) DC and the shell is (centre positive).

DELTA	DELTA-ADP-150TB-150W/19V
HP	HP-TBC-BA52-150W/19V
FSP	FSP-FSP150-ABAN1-150W/19V
DELL	FA130PE1-00-130W/19.5V
DELL	LA90PE0-01-90W/19.5V

This motherboard is available with support for either 2-pin ATX 19V power or DC-in power supplies. Please do not use two kinds of power supplies at the same time! Doing so may damage the motherboard components and devices. When you use the DC-in power adapter, please use the onboard SATA power connector to get the power for HDDs.

Chapter 2 Installation

This is a Thin Mini-ITX form factor motherboard. Before you install the motherboard, study the configuration of your chassis to ensure that the motherboard fits into it.

Pre-installation Precautions

Take note of the following precautions before you install motherboard components or change any motherboard settings.

- Make sure to unplug the power cord before installing or removing the motherboard components. Failure to do so may cause physical injuries and damages to motherboard components.
- In order to avoid damage from static electricity to the motherboard's components, NEVER place your motherboard directly on a carpet. Also remember to use a grounded wrist strap or touch a safety grounded object before you handle the components.
- Hold components by the edges and do not touch the ICs.
- Whenever you uninstall any components, place them on a grounded anti-static pad or in the bag that comes with the components.
- When placing screws to secure the motherboard to the chassis, please do not over-tighten the screws! Doing so may damage the motherboard.

2.1 Installing the CPU



1. Before you insert the 1151-Pin CPU into the socket, please check if the **PnP cap** is on the socket, if the CPU surface is unclean, or if there are any **bent pins** in the socket. Do not force to insert the CPU into the socket if above situation is found. Otherwise, the CPU will be seriously damaged.
2. Unplug all power cables before installing the CPU.

1

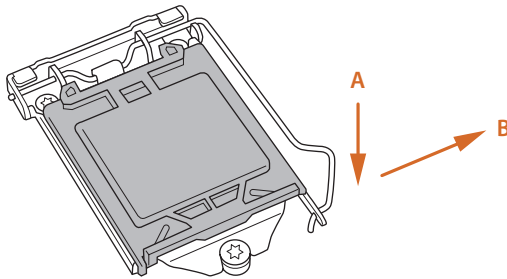

2

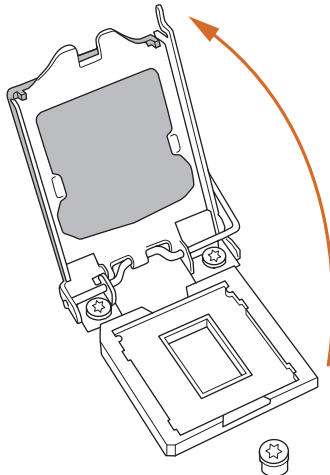

3

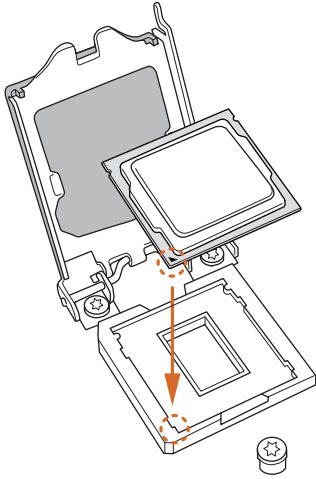

4

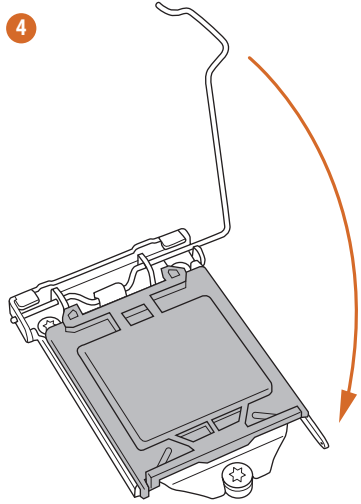

5

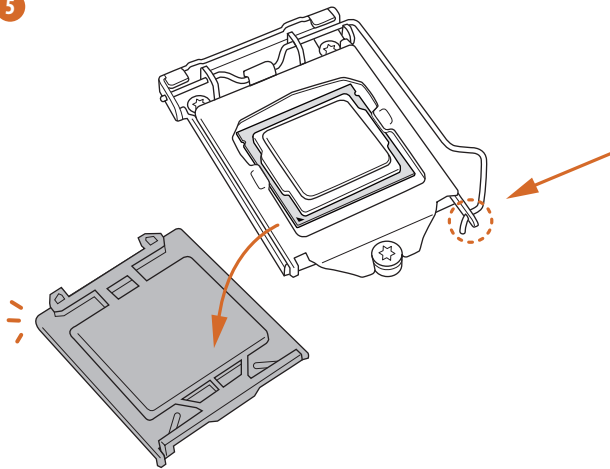



Please save and replace the cover if the processor is removed. The cover must be placed if you wish to return the motherboard for after service.

2.2 Installing the CPU Fan and Heatsink

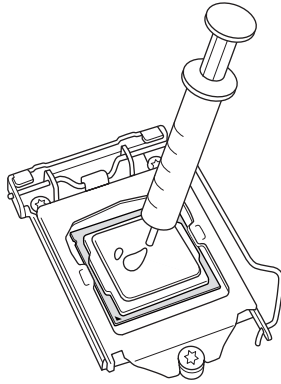
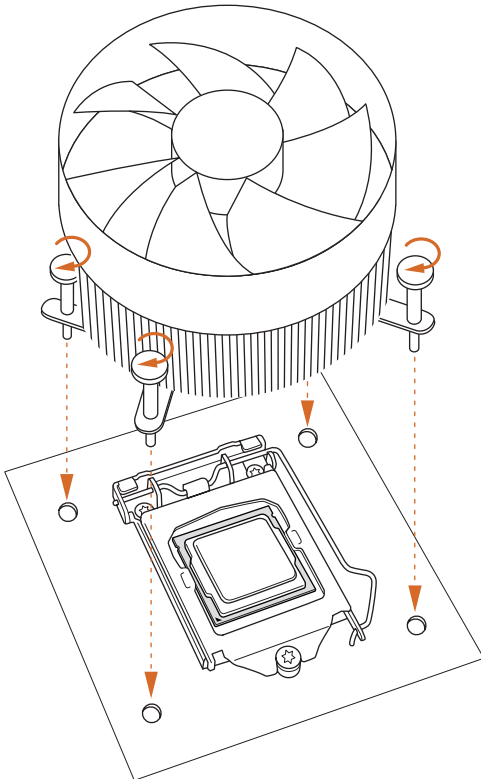
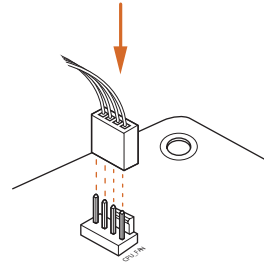
**1****2**

2.3 Installing Memory Modules (SO-DIMM)

This motherboard provides two 260-pin DDR4 (Double Data Rate 4) SO-DIMM slots.



It is not allowed to install a DDR, DDR2 or DDR3 memory module into a DDR4 slot; otherwise, this motherboard and SO-DIMM may be damaged.



The SO-DIMM only fits in one correct orientation. It will cause permanent damage to the motherboard and the SO-DIMM if you force the SO-DIMM into the slot at incorrect orientation.

1

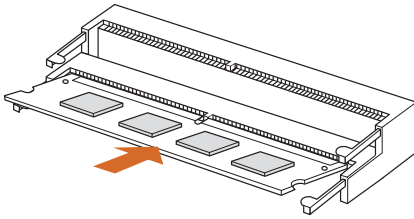

2

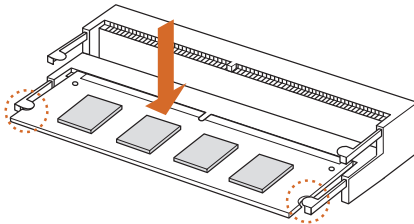

2.4 Jumpers Setup

The illustration shows how jumpers are setup. When the jumper cap is placed on the pins, the jumper is “Short”. If no jumper cap is placed on the pins, the jumper is “Open”. The illustration shows a 3-pin jumper whose pin1 and pin2 are “Short” when a jumper cap is placed on these 2 pins.

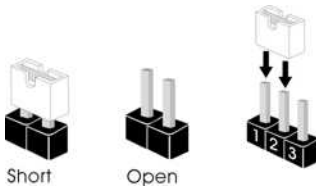

Clear CMOS Jumper
(CLRMOS1)
(see p.6, No. 2)



CLRMOS1 allows you to clear the data in CMOS. To clear and reset the system parameters to default setup, please turn off the computer and unplug the power cord from the power supply. After waiting for 15 seconds, use a jumper cap to short pin2 and pin3 on CLRMOS1 for 5 seconds. However, please do not clear the CMOS right after you update the BIOS. If you need to clear the CMOS when you just finish updating the BIOS, you must boot up the system first, and then shut it down before you do the clear-CMOS action. Please be noted that the password, date, time, and user default profile will be cleared only if the CMOS battery is removed.

Backlight Power Jumper
(3-pin BKT_PWR1)
(see p.6, No. 13)



1-2 : +19V
2-3 : +12V [Default]

Panel Power Jumper
(3-pin PNL_PWR1)
(see p.6, No. 14)



1-2 : +3V
2-3 : +5V [Default]

Warning:

If selected Backlight Power or Panel Power is higher than panel's spec, it may damage the panel.

2.5 Onboard Headers and Connectors



Onboard headers and connectors are NOT jumpers. Do NOT place jumper caps over these headers and connectors. Placing jumper caps over the headers and connectors will cause permanent damage to the motherboard.

System Panel Header
(9-pin PANEL1)
(see p.6, No. 11)

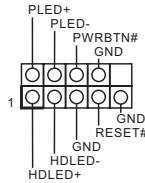

Connect the power switch, reset switch and system status indicator on the chassis to this header according to the pin assignments below. Note the positive and negative pins before connecting the cables.



PWRBTN (Power Switch):

Connect to the power switch on the chassis front panel. You may configure the way to turn off your system using the power switch.

RESET (Reset Switch):

Connect to the reset switch on the chassis front panel. Press the reset switch to restart the computer if the computer freezes and fails to perform a normal restart.

PLED (System Power LED):

Connect to the power status indicator on the chassis front panel. The LED is on when the system is operating. The LED keeps blinking when the system is in S1/S3 sleep state. The LED is off when the system is in S4 sleep state or powered off (S5).

HDLED (Hard Drive Activity LED):

Connect to the hard drive activity LED on the chassis front panel. The LED is on when the hard drive is reading or writing data.

The front panel design may differ by chassis. A front panel module mainly consists of power switch, reset switch, power LED, hard drive activity LED, speaker and etc. When connecting your chassis front panel module to this header, make sure the wire assignments and the pin assignments are matched correctly.

Serial ATA3 Connectors

(SATA3_0:
see p.6, No. 7)
(SATA3_1:
see p.6, No. 8)

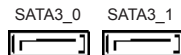

These two SATA3 connectors support SATA data cables for internal storage devices with up to 6.0 Gb/s data transfer rate.

SATA Power Connector
(SATA_POW1)
(see p.6, No. 9)



Please connect a SATA power cable.

USB 2.0 Headers
(5-pin USB6)
(see p.6, No. 3)

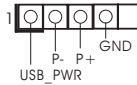

There are three headers on this motherboard.

(9-pin USB2_3)
(see p.6, No. 20)

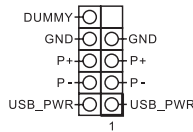

(9-pin USB4_5)
(see p.6, No. 4)

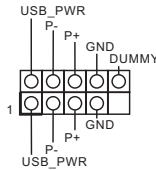

USB 3.1 Gen1 Header
(19-pin USB3_4_5)
(see p.6, No. 5)

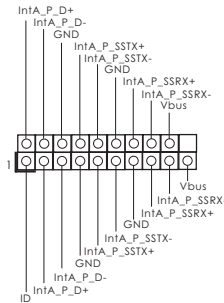

There is one header on this motherboard. This USB 3.1 Gen1 header can support two ports.

Front Panel Audio Header
(9-pin HD_AUDIO1)
(see p.6, No. 22)

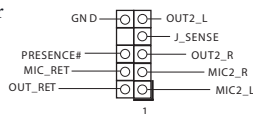

This header is for connecting audio devices to the front audio panel.



1. High Definition Audio supports Jack Sensing, but the panel wire on the chassis must support HDA to function correctly. Please follow the instructions in our manual and chassis manual to install your system.
2. If you use an AC'97 audio panel, please install it to the front panel audio header by the steps below:
 - A. Connect Mic_IN (MIC) to MIC2_L.
 - B. Connect Audio_R (RIN) to OUT2_R and Audio_L (LIN) to OUT2_L.
 - C. Connect Ground (GND) to Ground (GND).
 - D. MIC_RET and OUT_RET are for the HD audio panel only. You don't need to connect them for the AC'97 audio panel.
 - E. To activate the front mic, go to the "FrontMic" Tab in the Realtek Control panel and adjust "Recording Volume".

Analog Surround
Audio Header
(17-pin HD_AUDIO2)
(see p.6, No. 26)

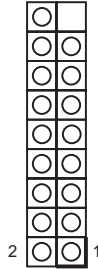

PIN	Signal Name	PIN	Signal Name
18	SENSE	17	KEY
16	LFE	15	A_GND
14	A_GND	13	Center
12	Surr_Rear_R	11	A_GND
10	A_GND	9	Surr_Rear_L
8	Surr_Side_R	7	A_GND
6	A_GND	5	Surr_Side_L
4	Front_R	3	A_GND
2	A_GND	1	Front_L

3W Audio AMP Output
Wafer Header
(4-pin SPEAKER1)
(see p.6, No. 25)

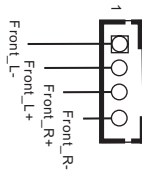

Please connect the chassis speaker to this header.

SPDIF Out Connector
(2-pin HDMI_SPDIF1)
(see p.6, No. 24)



Please connect the SPDIF Out connector of a HDMI VGA card to this header with a cable.

Chassis Fan Connector
(4-pin CHA_FAN1)
(see p.6, No. 6)

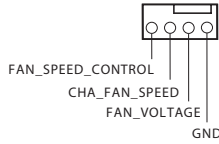

Please connect fan cable to the fan connector and match the black wire to the ground pin.

CPU Fan Connector
(4-pin CPU_FAN1)
(see p.6, No. 19)

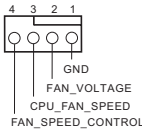

This motherboard provides a 4-Pin CPU fan (Quiet Fan) connector. If you plan to connect a 3-Pin CPU fan, please connect it to Pin 1-3.

Internal Power Header
(2-pin ATX19V_IN1)
(see p.6, No. 1)



This motherboard provides a 2-pin ATX 19V power connector.

Consumer Infrared Module Header
(7-pin CIR1)
(see p.6, No. 12)

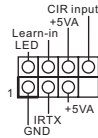

This header can be used to connect the remote controller receiver.

Serial Port Header
(9-pin COM1)
(see p.6, No. 17)

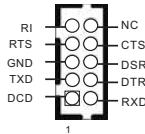

This header supports serial port modules.

Backlight Control Header
(8-pin BLT_VOL1)
(see p.6, No. 16)

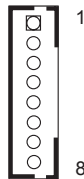

- 1: BKLT_EN
- 2: BKLT_PWM
- 3: BKLT_PWR
- 4: BKLT_PWR
- 5: GND
- 6: GND
- 7: Brightness_Up
- 8: Brightness_Down

Digital MIC Header
(5-pin DMIC1)
(see p.6, No. 23)



- 1: +5V
- 2: No pin
- 3: SPDIF_OUT/DMIC_
CLK
- 4: GND
- 5: DMIC_DATA
- 6: +3.3V

Home Theater PC
Header
(7-pin HTPC1)
(see p.6, No. 21)



PIN	Signal Name	PIN	Signal Name
8	HDMI CEC	7	#Power_Button
6	SMB_DATA	5	3.3V Standby
4	SMB_CLK	3	No pin
2	GND	1	Recording LED

LVDS Panel Connector
(40-pin LVDS1)
(see p.6, No. 15)

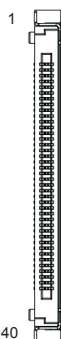

PIN	Signal Name	PIN	Signal Name
1	ODD_Lane3_P	21	NC
2	ODD_Lane3_N	22	EDID_3.3V
3	ODD_Lane2_P	23	LCD_GND
4	ODD_Lane2_N	24	LCD_GND
5	ODD_Lane1_P	25	LCD_GND
6	ODD_Lane1_N	26	ODD_CLK_P
7	ODD_Lane0_P	27	ODD_CLK_N
8	ODD_Lane0_N	28	BKLT_GND
9	EVEN_Lane3_P	29	BKLT_GND
10	EVEN_Lane3_N	30	BKLT_GND
11	EVEN_Lane2_P	31	EDID_CLK
12	EVEN_Lane2_N	32	BKLT_ENABLE
13	EVEN_Lane1_P	33	BKLT_PWM_DIM
14	EVEN_Lane1_N	34	EVEN_CLK_P
15	EVEN_Lane0_P	35	EVEN_CLK_N
16	EVEN_Lane0_N	36	BKLT_PWR (12V/19V)
17	EDID_GND	37	BKLT_PWR (12V/19V)

PIN	Signal Name	PIN	Signal Name
18	LCD_VCC (3.3V/5V/12V)	38	BKLT_PWR (12V/19V)
19	LCD_VCC (3.3V/5V/12V)	39	NC
20	LCD_VCC (3.3V/5V/12V)	40	EDID_DATA

Monitor Switch Header
(2-pin MONITOR_
SWITCH1)
(see p.6, No. 10)

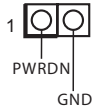

This header can be used to connect a switch that turns on/off the LVDS panel display's backlight.

2.6 M.2 WiFi/BT Module Installation Guide

The M.2, also known as the Next Generation Form Factor (NGFF), is a small size and versatile card edge connector that aims to replace mPCIe and mSATA. The M.2 Socket (Key E) (M2_1) supports type 2230 WiFi/BT module.

Installing the WiFi/BT module

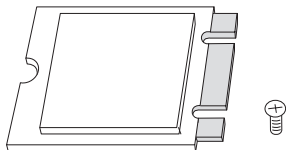

Step 1

Prepare a type 2230 WiFi/BT module and the screw.

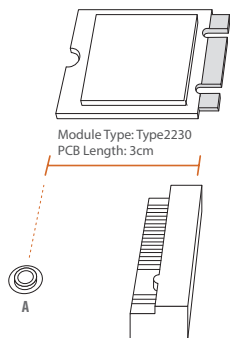

Step 2

Find the nut location to be used.

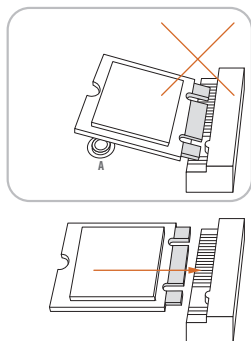

Step 3

Align and gently insert the WiFi/BT module into the M.2 slot. Please be aware that the module only fits in one orientation.

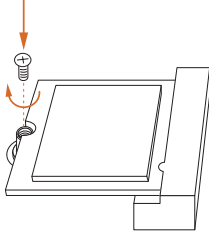
**Step 4**

Tighten the screw with a screwdriver to secure the module into place. Please do not overtighten the screw as this might damage the module.

Chapter 3 Software and Utilities Operation

3.1 Installing Drivers

The Support CD that comes with the motherboard contains necessary drivers and useful utilities that enhance the motherboard's features.

Running The Support CD

To begin using the support CD, insert the CD into your CD-ROM drive. The CD automatically displays the Main Menu if "AUTORUN" is enabled in your computer. If the Main Menu does not appear automatically, locate and double click on the file "ASRSETUP.EXE" in the Support CD to display the menu.

Drivers Menu

The drivers compatible to your system will be auto-detected and listed on the support CD driver page. Please click **Install All** or follow the order from top to bottom to install those required drivers. Therefore, the drivers you install can work properly.

Utilities Menu

The Utilities Menu shows the application software that the motherboard supports. Click on a specific item then follow the installation wizard to install it.



*To improve Windows 7 compatibility, please download and install the following hot fix provided by Microsoft.
"KB2720599": <http://support.microsoft.com/kb/2720599/en-us>*

3.2 ASRock Live Update & APP Shop

The ASRock Live Update & APP Shop is an online store for purchasing and downloading software applications for your ASRock computer. You can quickly and easily install various apps and support utilities, such as USB Key, XFast LAN, XFast RAM and more. With ASRock Live Update & APP Shop, you can optimize your system and keep your motherboard up to date simply with a few clicks.

Double-click  on your desktop to access ASRock Live Update & APP Shop utility.

**You need to be connected to the Internet to download apps from the ASRock Live Update & APP Shop.*

3.2.1 UI Overview

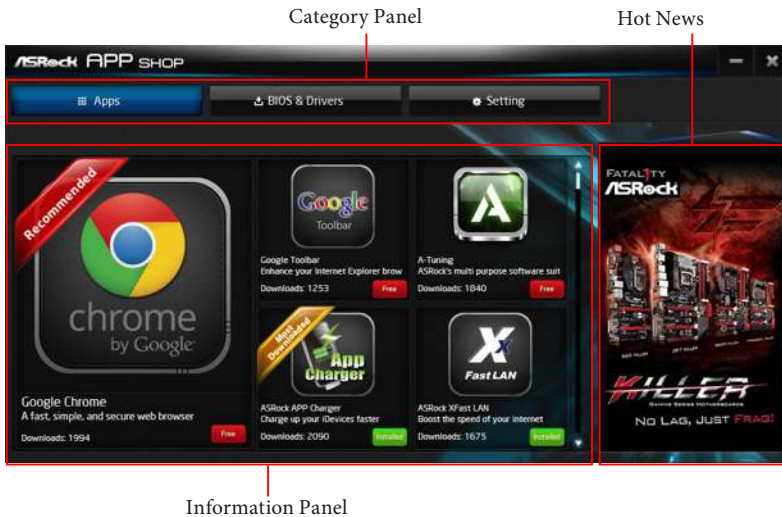

Category Panel: The category panel contains several category tabs or buttons that when selected the information panel below displays the relative information.

Information Panel: The information panel in the center displays data about the currently selected category and allows users to perform job-related tasks.

Hot News: The hot news section displays the various latest news. Click on the image to visit the website of the selected news and know more.

3.2.2 Apps

When the "Apps" tab is selected, you will see all the available apps on screen for you to download.

Installing an App

Step 1

Find the app you want to install.



The most recommended app appears on the left side of the screen. The other various apps are shown on the right. Please scroll up and down to see more apps listed.

You can check the price of the app and whether you have already installed it or not.

 - The red icon displays the price or "Free" if the app is free of charge.

 - The green "Installed" icon means the app is installed on your computer.

Step 2

Click on the app icon to see more details about the selected app.

Step 3

If you want to install the app, click on the red icon  to start downloading.

**Step 4**

When installation completes, you can find the green "Installed" icon appears on the upper right corner.



To uninstall it, simply click on the trash can icon .

*The trash icon may not appear for certain apps.

Upgrading an App

You can only upgrade the apps you have already installed. When there is an available new version for your app, you will find the mark of "New Version"  appears below the installed app icon.



Step 1

Click on the app icon to see more details.

Step 2

Click on the yellow icon  to start upgrading.

3.2.3 BIOS & Drivers

Installing BIOS or Drivers

When the "BIOS & Drivers" tab is selected, you will see a list of recommended or critical updates for the BIOS or drivers. Please update them all soon.

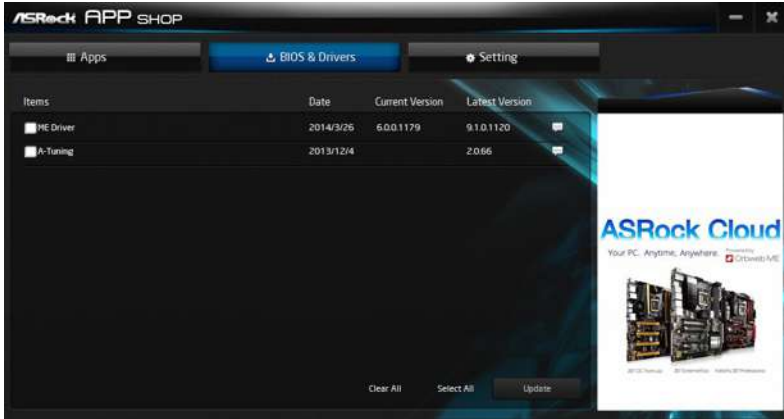

Step 1

Please check the item information before update. Click on  to see more details.

Step 2

Click to select one or more items you want to update.

Step 3

Click Update to start the update process.

3.2.4 Setting

In the "Setting" page, you can change the language, select the server location, and determine if you want to automatically run the ASRock Live Update & APP Shop on Windows startup.

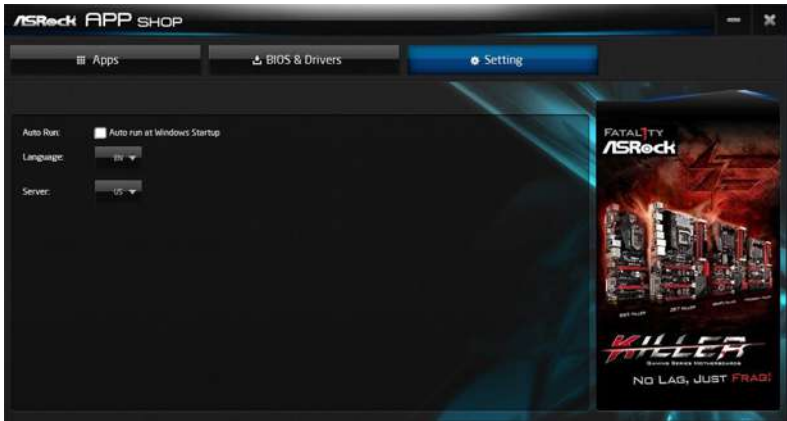

3.3 Enabling USB Ports for Windows® 7 Installation

Intel® Braswell and Skylake has removed their support for the Enhanced Host Controller Interface (EHCI – USB2.0) and only kept the eXtensible Host Controller Interface (XHCI – USB3.0). Due to that fact that XHCI is not included in the Windows 7 inbox drivers, users may find it difficult to install Windows 7 operating system because the USB ports on their motherboard won't work. In order for the USB ports to function properly, please create a Windows® 7 installation disk with the Intel® USB 3.1 Gen1 eXtensible Host Controller (xHCI) drivers packed into the ISO file.

Requirements

- A Windows® 7 installation disk or USB drive
- USB 3.1 Gen1 drivers (included in the ASRock Support CD or website)
- A Windows® PC
- Win7 USB Patcher (included in the ASRock Support CD or website)

Scenarios

You have an ODD and PS/2 ports:

If there is an optical disc drive, PS/2 ports and PS/2 Keyboard or mouse on your computer, you can skip the instructions below and go ahead to install Windows® 7 OS.

You only have an ODD (*For Intel Skylake platforms only*):

If there is an optical disc drive but no PS/2 ports on your computer, please enable the “PS/2 Simulator” option in *UEFI SETUP UTILITY > Advanced > USB Configuration*, which allows the USB port to function as a PS/2 port, and then you can install the Windows® 7 OS. Please set PS/S Simulator back to disabled after the installation.

You've got nothing:

If you do not have an optical disc drive, please find another computer and follow the instructions below to create a new ISO file with the “Win7 USB Patcher”. Then use the new patched Windows® 7 installation USB drive to install Windows® 7 OS.

Instructions

Step 1

Insert the Windows® 7 installation disk or USB drive to your system.

Step 2

Extract the tool (Win7 USB Patcher) and launch it.

Step 3

Select the “Win7 Folder” from Step1 by clicking the red circle as shown as the picture below.

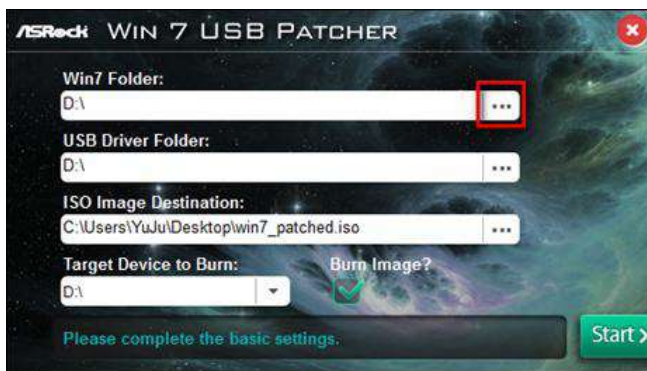

Step 4

Select the “USB Driver Folder” by clicking the red circle as shown as the picture below.



If you are using ASRock's Support CD for the USB 3.1 Gen1 driver, please select your CD-ROM.

Step 5

Select where to save the ISO file by pressing the red circle as shown as the picture below.

**Step 6**

If you want to burn the patched image to a CD, please check “Burn Image” and select “Target Device to Burn”. If not, the patched ISO image will be exported to the destination selected in Step5. Then Press “Start” to proceed.

Step 7

Now you are able to install Windows® 7 on Braswell or Skylake with the new burned CD. Or please use the patched ISO image to make an OS USB drive to install the OS.

Chapter 4 UEFI SETUP UTILITY

4.1 Introduction

This section explains how to use the UEFI SETUP UTILITY to configure your system. You may run the UEFI SETUP UTILITY by pressing <F2> or right after you power on the computer, otherwise, the Power-On-Self-Test (POST) will continue with its test routines. If you wish to enter the UEFI SETUP UTILITY after POST, restart the system by pressing <Ctl> + <Alt> + <Delete>, or by pressing the reset button on the system chassis. You may also restart by turning the system off and then back on.



Because the UEFI software is constantly being updated, the following UEFI setup screens and descriptions are for reference purpose only, and they may not exactly match what you see on your screen.

4.2 EZ Mode

The EZ Mode screen appears when you enter the BIOS setup program by default. EZ mode is a dashboard which contains multiple readings of the system's current status. You can check the most crucial information of your system, such as CPU speed, DRAM frequency, SATA information, fan speed, etc.

Press <F6> or click the "Advanced Mode" button at the upper right corner of the screen to switch to "Advanced Mode" for more options.



No.	Function
1	Help
2	Load UEFI Defaults
3	Save Changes and Exit
4	Discard Changes
5	Change Language
6	Switch to Advanced Mode

4.3 Advanced Mode

The Advanced Mode provides more options to configure the BIOS settings. Refer to the following sections for the detailed configurations.

To access the EZ Mode, press <F6> or click the "EZ Mode" button at the upper right corner of the screen.

4.3.1 UEFI Menu Bar

The top of the screen has a menu bar with the following selections:

Main	For setting system time/date information
OC Tweaker	For overclocking configurations
Advanced	For advanced system configurations
Tool	Useful tools
H/W Monitor	Displays current hardware status
Boot	For configuring boot settings and boot priority
Security	For security settings
Exit	Exit the current screen or the UEFI Setup Utility

4.3.2 Navigation Keys

Use <←> key or <→> key to choose among the selections on the menu bar, and use <↑> key or <↓> key to move the cursor up or down to select items, then press <Enter> to get into the sub screen. You can also use the mouse to click your required item.

Please check the following table for the descriptions of each navigation key.

Navigation Key(s)	Description
+ / -	To change option for the selected items
<Tab>	Switch to next function
<PGUP>	Go to the previous page
<PGDN>	Go to the next page
<HOME>	Go to the top of the screen
<END>	Go to the bottom of the screen
<F1>	To display the General Help Screen
<F5>	Add / Remove Favorite
<F7>	Discard changes and exit the SETUP UTILITY
<F9>	Load optimal default values for all the settings
<F10>	Save changes and exit the SETUP UTILITY
<F12>	Print screen
<ESC>	Jump to the Exit Screen or exit the current screen

4.4 Main Screen

When you enter the UEFI SETUP UTILITY, the Main screen will appear and display the system overview.



My Favorite

Display your collection of BIOS items. Press F5 to add/remove your favorite items.

4.5 OC Tweaker Screen

In the OC Tweaker screen, you can set up overclocking features.



Because the UEFI software is constantly being updated, the following UEFI setup screens and descriptions are for reference purpose only, and they may not exactly match what you see on your screen.

CPU Configuration

Intel SpeedStep Technology

Intel SpeedStep technology allows processors to switch between multiple frequencies and voltage points for better power saving and heat dissipation.

Intel Turbo Boost Technology

Intel Turbo Boost Technology enables the processor to run above its base operating frequency when the operating system requests the highest performance state.

DRAM Configuration

DRAM Tweaker

Fine tune the DRAM settings by leaving marks in checkboxes. Click OK to confirm and apply your new settings.

DRAM Timing Configuration

DRAM Reference Clock

Select Auto for optimized settings.

DRAM Frequency

If [Auto] is selected, the motherboard will detect the memory module(s) inserted and assign the appropriate frequency automatically.

Primary Timing

CAS# Latency (tCL)

The time between sending a column address to the memory and the beginning of the data in response.

RAS# to CAS# Delay and Row Precharge (tRCDtRP)

RAS# to CAS# Delay: The number of clock cycles required between the opening of a row of memory and accessing columns within it.

Row Precharge: The number of clock cycles required between the issuing of the precharge command and opening the next row.

RAS# Active Time (tRAS)

The number of clock cycles required between a bank active command and issuing the precharge command.

Command Rate (CR)

The delay between when a memory chip is selected and when the first active command can be issued.

Secondary Timing

Write Recovery Time (tWR)

The amount of delay that must elapse after the completion of a valid write operation, before an active bank can be precharged.

Refresh Cycle Time (tRFC)

The number of clocks from a Refresh command until the first Activate command to the same rank.

RAS to RAS Delay (tRRD_L)

The number of clocks between two rows activated in different banks of the same rank.

RAS to RAS Delay (tRRD_S)

The number of clocks between two rows activated in different banks of the same rank.

Write to Read Delay (tWTR_L)

The number of clocks between the last valid write operation and the next read command to the same internal bank.

Write to Read Delay (tWTR_S)

The number of clocks between the last valid write operation and the next read command to the same internal bank.

Read to Precharge (tRTP)

The number of clocks that are inserted between a read command to a row pre-charge command to the same rank.

Four Activate Window (tFAW)

The time window in which four activates are allowed the same rank.

CAS Write Latency (tCWL)

Configure CAS Write Latency.

Third Timing**tREFI**

Configure refresh cycles at an average periodic interval.

tCKE

Configure the period of time the DDR4 initiates a minimum of one refresh command internally once it enters Self-Refresh mode.

tRDRD_sg

Configure between module read to read delay.

tRDRD_dg

Configure between module read to read delay.

tRDRD_dr

Configure between module read to read delay.

tRDRD_dd

Configure between module read to read delay.

tRDWR_sg

Configure between module read to write delay.

tRDWR_dg

Configure between module read to write delay.

tRDWR_dr

Configure between module read to write delay.

tRDWR_dd

Configure between module read to write delay.

tWRRD_sg

Configure between module write to read delay.

tWRRD_dg

Configure between module write to read delay.

tWRRD_dr

Configure between module write to read delay.

tWRRD_dd

Configure between module write to read delay.

tWRWR_sg

Configure between module write to write delay.

tWRWR_dg

Configure between module write to write delay.

tWRWR_dr

Configure between module write to write delay.

tWRWR_dd

Configure between module write to write delay.

RTL (CH A)

Configure round trip latency for channel A.

RTL (CH B)

Configure round trip latency for channel B.

IO-L (CH A)

Configure IO latency for channel A.

IO-L (CH B)

Configure IO latency for channel B.

Fourth Timing**twRPRE**

Configure twRPRE.

Write_Early_ODT

Configure Write_Early_ODT.

tAONPD

Configure tAONPD.

tXP

Configure tXP.

tXPDLL

Configure tXPDLL.

tPRPDEN

Configure tPRPDEN.

tRDPDEN

Configure tRDPDEN.

twRPDEN

Configure twRPDEN.

OREF_RI

Configure OREF_RI.

tREFIx9

Configure tREFIx9.

txSDLL

Configure txSDLL.

txs_offset

Configure txs_offset.

tZQOPER

Configure tZQOPER.

tMOD

Configure tMOD.

ZQCS_period

Configure ZQCS_period.

tZQCS

Configure tZQCS.

Advanced Setting

ODT WR (CH A)

Configure the memory on die termination resistors' WR for channel A.

ODT WR (CH B)

Configure the memory on die termination resistors' WR for channel B.

ODT PARK (CH A)

Configure the memory on die termination resistors' PARK for channel A.

ODT PARK (CH B)

Configure the memory on die termination resistors' PARK for channel B.

ODT NOM (CH A)

Use this to change ODT (CH A) Auto/Manual settings. The default is [Auto].

ODT NOM (CH B)

Use this to change ODT (CH B) Auto/Manual settings. The default is [Auto].

MRC Fast Boot

Enable Memory Fast Boot to skip DRAM memory training for booting faster.

Voltage Configuration

DRAM Voltage

Use this to configure DRAM Voltage. The default value is [Auto].

Save User Default

Type a profile name and press enter to save your settings as user default.

Load User Default

Load previously saved user defaults.

4.6 Advanced Screen

In this section, you may set the configurations for the following items: CPU Configuration, Chipset Configuration, Storage Configuration, Super IO Configuration, ACPI Configuration and USB Configuration.



Setting wrong values in this section may cause the system to malfunction.

UEFI Configuration

UEFI Setup Style

Select the default mode when entering the UEFI setup utility.

Active Page on Entry

Select the default page when entering the UEFI setup utility.

4.6.1 CPU Configuration



Intel Hyper Threading Technology

Intel Hyper Threading Technology allows multiple threads to run on each core, so that the overall performance on threaded software is improved.

Active Processor Cores

Select the number of cores to enable in each processor package.

CPU C States Support

Enable CPU C States Support for power saving. It is recommended to keep C3, C6 and C7 all enabled for better power saving.

Enhanced Halt State (C1E)

Enable Enhanced Halt State (C1E) for lower power consumption.

CPU C3 State Support

Enable C3 sleep state for lower power consumption.

CPU C6 State Support

Enable C6 deep sleep state for lower power consumption.

CPU C7 State Support

Enable C7 deep sleep state for lower power consumption.

Package C State Support

Enable CPU, PCIe, Memory, Graphics C State Support for power saving.

CPU Thermal Throttling

Enable CPU internal thermal control mechanisms to keep the CPU from overheating.

No-Execute Memory Protection

Processors with No-Execution Memory Protection Technology may prevent certain classes of malicious buffer overflow attacks.

Intel Virtualization Technology

Intel Virtualization Technology allows a platform to run multiple operating systems and applications in independent partitions, so that one computer system can function as multiple virtual systems.

Hardware Prefetcher

Automatically prefetch data and code for the processor. Enable for better performance.

Adjacent Cache Line Prefetch

Automatically prefetch the subsequent cache line while retrieving the currently requested cache line. Enable for better performance.

SW Guard Extensions (SGX)

Intel SGX is a set of new CPU instructions that can be used by applications to set aside private regions of code and data.

4.6.2 Chipset Configuration



Top Of Lower Usable Dram

Maximum Value of TOLUD. Dynamic assignment would adjust TOLUD automatically based on largest MMIO length of installed graphic controller.

VT-d

Intel® Virtualization Technology for Directed I/O helps your virtual machine monitor better utilize hardware by improving application compatibility and reliability, and providing additional levels of manageability, security, isolation, and I/O performance.

DMI ASPM Support

This option enables/disables the control of ASPM on CPU side of the DMI Link.

PCH DMI ASPM Support

This option enables/disables the ASPM support for all PCH DMI devices.

IOAPIC 24-119 Entries

I/O APICs contain a redirection table, which is used to route the interrupts it receives from peripheral buses to one or more local APICs. Enable/disable IOAPIC 24-119 Entries to expand to PIROI-PIROX.

Share Memory

Configure the size of memory that is allocated to the integrated graphics processor when the system boots up.

Render Standby

Power down the render unit when the GPU is idle for lower power consumption.

Onboard LAN

Enable or disable the onboard network interface controller.

Onboard HD Audio

Enable/disable onboard HD audio. Set to Auto to enable onboard HD audio and automatically disable it when a sound card is installed.

Front Panel

Select Front Panel type.

Onboard HDMI HD Audio

Enable audio for the onboard digital outputs.

WAN Radio

Enable/disable the WiFi module's connectivity.

Deep Sleep

Configure deep sleep mode for power saving when the computer is shut down.

Restore on AC/Power Loss

Select the power state after a power failure. If [Power Off] is selected, the power will remain off when the power recovers. If [Power On] is selected, the system will start to boot up when the power recovers.

Good Night LED

By enabling Good Night LED, the Power/HDD LEDs will be switched off when the system is on. It will also automatically switch off the Power and Keyboard LEDs when the system enters into Standby/Hibernation mode.

Active LVDS

This allows you to enable or disable the LVDS.

4.6.3 Storage Configuration



SATA Controller(s)

Enable/disable the SATA controllers.

SATA Aggressive Link Power Management

SATA Aggressive Link Power Management allows SATA devices to enter a low power state during periods of inactivity to save power. It is only supported by AHCI mode.

Hard Disk S.M.A.R.T.

S.M.A.R.T stands for Self-Monitoring, Analysis, and Reporting Technology. It is a monitoring system for computer hard disk drives to detect and report on various indicators of reliability.

4.6.4 Super IO Configuration



Serial Port 1

Enable or disable the Serial port.

Serial Port Address

Select the address of the Serial port.

4.6.5 ACPI Configuration



Suspend to RAM

Select disable for ACPI suspend type S1. It is recommended to select auto for ACPI S3 power saving.

ACPI HEPT Table

Enable the High Precision Event Timer for better performance.

Ring-In Power On

Allow the system to be waked up by onboard COM port modem Ring-In signals.

RTC Alarm Power On

Allow the system to be waked up by the real time clock alarm. Set it to By OS to let it be handled by your operating system.

USB Keyboard/Remote Power On

Allow the system to be waked up by an USB keyboard or remote controller.

USB Mouse Power On

Allow the system to be waked up by an USB mouse.

4.6.6 USB Configuration



PS/2 Simulator

Enable PS/2 Simulator. This should be enabled for the complete USB keyboard legacy support for non-USB aware OSes.

*Enable this option if you install Windows 7.

4.7 Tools



OMG (Online Management Guard)

Administrators are able to establish an internet curfew or restrict internet access at specified times via OMG. You may schedule the starting and ending hours of internet access granted to other users. In order to prevent users from bypassing OMG, guest accounts without permission to modify the system time are required.

UEFI Tech Service

Contact ASRock Tech Service if you are having trouble with your PC. Please setup network configuration before using UEFI Tech Service.

Easy Driver Installer

For users that don't have an optical disk drive to install the drivers from our support CD, Easy Driver Installer is a handy tool in the UEFI that installs the LAN driver to your system via an USB storage device, then downloads and installs the other required drivers automatically.

Boot Manager

Boot Manager is specifically designed for the dual OS platform/multi-OS platform users to easily customize and manage the boot menu.

*Please connect more than one boot devices to use this tool.



Boot Manager

Enable/disable the Boot Manager.

Boot Manager Timeout

Enable/disable the Boot Manager Timeout.

Timeout Seconds

Configure the number of seconds to wait for the Boot Manager.

Instant Flash

Save UEFI files in your USB storage device and run Instant Flash to update your UEFI.

Internet Flash - DHCP (Auto IP), Auto

ASRock Internet Flash downloads and updates the latest UEFI firmware version from our servers for you. Please setup network configuration before using Internet Flash.

*For BIOS backup and recovery purpose, it is recommended to plug in your USB pen drive before using this function.

Network Configuration

Use this to configure internet connection settings for Internet Flash.



Internet Setting

Enable or disable sound effects in the setup utility.

UEFI Download Server

Select a server to download the UEFI firmware.

4.8 Hardware Health Event Monitoring Screen

This section allows you to monitor the status of the hardware on your system, including the parameters of the CPU temperature, motherboard temperature, fan speed and voltage.



Fan-Tastic Tuning

Select a fan mode for CPU Fan 1, or choose Customize to set 5 CPU temperatures and assign a respective fan speed for each temperature.

CPU Fan 1 Setting

Select a fan mode for CPU Fan 1, or choose Customize to set 5 CPU temperatures and assign a respective fan speed for each temperature.

Chassis Fan 1 Setting

Select a fan mode for Chassis Fan 1, or choose Customize to set 5 CPU temperatures and assign a respective fan speed for each temperature.

Chassis Fan 1 Temp Source

Select a fan temperature source for Chassis Fan 1.

4.9 Security Screen

In this section you may set or change the supervisor/user password for the system. You may also clear the user password.



Supervisor Password

Set or change the password for the administrator account. Only the administrator has authority to change the settings in the UEFI Setup Utility. Leave it blank and press enter to remove the password.

User Password

Set or change the password for the user account. Users are unable to change the settings in the UEFI Setup Utility. Leave it blank and press enter to remove the password.

Secure Boot

Use this item to enable or disable support for Windows 8.1 Secure Boot.

Intel(R) Platform Trust Technology

Enable/disable Intel PTT in ME. Disable this option to use discrete TPM Module.

4.10 Boot Screen

This section displays the available devices on your system for you to configure the boot settings and the boot priority.



Fast Boot

Fast Boot minimizes your computer's boot time. In fast mode you may not boot from an USB storage device. Ultra Fast mode is only supported by Windows 8.1 and the VBIOS must support UEFI GOP if you are using an external graphics card. Please notice that Ultra Fast mode will boot so fast that the only way to enter this UEFI Setup Utility is to Clear CMOS or run the Restart to UEFI utility in Windows.

Boot From Onboard LAN

Allow the system to be waked up by the onboard LAN.

Setup Prompt Timeout

Configure the number of seconds to wait for the setup hot key.

Bootup Num-Lock

Select whether Num Lock should be turned on or off when the system boots up.

Boot Beep

Select whether the Boot Beep should be turned on or off when the system boots up. Please note that a buzzer is needed.

Full Screen Logo

Enable to display the boot logo or disable to show normal POST messages.

AddOn ROM Display

Enable AddOn ROM Display to see the AddOn ROM messages or configure the AddOn ROM if you've enabled Full Screen Logo. Disable for faster boot speed.

Boot Failure Guard Message

If the computer fails to boot for a number of times the system automatically restores the default settings.

CSM (Compatibility Support Module)



CSM

Enable to launch the Compatibility Support Module. Please do not disable unless you're running a WHCK test. If you are using Windows 8.1 64-bit and all of your devices support UEFI, you may also disable CSM for faster boot speed.

Launch PXE OpROM Policy

Select UEFI only to run those that support UEFI option ROM only. Select Legacy only to run those that support legacy option ROM only. Select Do not launch to not execute both legacy and UEFI option ROM.

Launch Storage OpROM Policy

Select UEFI only to run those that support UEFI option ROM only. Select Legacy only to run those that support legacy option ROM only. Select Do not launch to not execute both legacy and UEFI option ROM.

Launch Video OpROM Policy

Select UEFI only to run those that support UEFI option ROM only. Select Legacy only to run those that support legacy option ROM only. Select Do not launch to not execute both legacy and UEFI option ROM.

4.11 Exit Screen



Save Changes and Exit

When you select this option the following message, “Save configuration changes and exit setup?” will pop out. Select [OK] to save changes and exit the UEFI SETUP UTILITY.

Discard Changes and Exit

When you select this option the following message, “Discard changes and exit setup?” will pop out. Select [OK] to exit the UEFI SETUP UTILITY without saving any changes.

Discard Changes

When you select this option the following message, “Discard changes?” will pop out. Select [OK] to discard all changes.

Load UEFI Defaults

Load UEFI default values for all options. The F9 key can be used for this operation.

Launch EFI Shell from filesystem device

Copy shellx64.efi to the root directory to launch EFI Shell.

Contact Information

If you need to contact ASRock or want to know more about ASRock, you're welcome to visit ASRock's website at <http://www.asrock.com>; or you may contact your dealer for further information. For technical questions, please submit a support request form at <http://www.asrock.com/support/tsd.asp>

ASRock Incorporation

2F., No.37, Sec. 2, Jhongyang S. Rd., Beitou District,

Taipei City 112, Taiwan (R.O.C.)

ASRock EUROPE B.V.

Bijsterhuizen 11-11

6546 AR Nijmegen

The Netherlands

Phone: +31-24-345-44-33

Fax: +31-24-345-44-38

ASRock America, Inc.

13848 Magnolia Ave, Chino, CA91710

U.S.A.

Phone: +1-909-590-8308

Fax: +1-909-590-1026