

**P6X58D  
Premium**

**ASUS**<sup>®</sup>

**Motherboard**

E4779

First Edition (V1)

November 2009

**Copyright © 2009 ASUSTeK COMPUTER INC. All Rights Reserved.**

No part of this manual, including the products and software described in it, may be reproduced, transmitted, transcribed, stored in a retrieval system, or translated into any language in any form or by any means, except documentation kept by the purchaser for backup purposes, without the express written permission of ASUSTeK COMPUTER INC. ("ASUS").

Product warranty or service will not be extended if: (1) the product is repaired, modified or altered, unless such repair, modification or alteration is authorized in writing by ASUS; or (2) the serial number of the product is defaced or missing.

ASUS PROVIDES THIS MANUAL "AS IS" WITHOUT WARRANTY OF ANY KIND, EITHER EXPRESS OR IMPLIED, INCLUDING BUT NOT LIMITED TO THE IMPLIED WARRANTIES OR CONDITIONS OF MERCHANTABILITY OR FITNESS FOR A PARTICULAR PURPOSE. IN NO EVENT SHALL ASUS, ITS DIRECTORS, OFFICERS, EMPLOYEES OR AGENTS BE LIABLE FOR ANY INDIRECT, SPECIAL, INCIDENTAL, OR CONSEQUENTIAL DAMAGES (INCLUDING DAMAGES FOR LOSS OF PROFITS, LOSS OF BUSINESS, LOSS OF USE OR DATA, INTERRUPTION OF BUSINESS AND THE LIKE), EVEN IF ASUS HAS BEEN ADVISED OF THE POSSIBILITY OF SUCH DAMAGES ARISING FROM ANY DEFECT OR ERROR IN THIS MANUAL OR PRODUCT.

SPECIFICATIONS AND INFORMATION CONTAINED IN THIS MANUAL ARE FURNISHED FOR INFORMATIONAL USE ONLY, AND ARE SUBJECT TO CHANGE AT ANY TIME WITHOUT NOTICE, AND SHOULD NOT BE CONSTRUED AS A COMMITMENT BY ASUS. ASUS ASSUMES NO RESPONSIBILITY OR LIABILITY FOR ANY ERRORS OR INACCURACIES THAT MAY APPEAR IN THIS MANUAL, INCLUDING THE PRODUCTS AND SOFTWARE DESCRIBED IN IT.

Products and corporate names appearing in this manual may or may not be registered trademarks or copyrights of their respective companies, and are used only for identification or explanation and to the owners' benefit, without intent to infringe.

# Contents

Contents.....	iii
Notices .....	vii
Safety information.....	viii
About this guide.....	ix
P6X58D Premium specifications summary .....	xi
<b>Chapter 1: Product introduction</b>	
1.1 Welcome!.....	1-1
1.2 Package contents.....	1-1
1.3 Special features.....	1-2
1.3.1 Product highlights.....	1-2
1.3.2 ASUS unique features.....	1-3
1.3.3 ASUS exclusive overclocking features.....	1-5
<b>Chapter 2: Hardware information</b>	
2.1 Before you proceed .....	2-1
2.2 Motherboard overview.....	2-2
2.2.1 Motherboard layout.....	2-2
2.2.2 Layout contents.....	2-3
2.2.3 Placement direction.....	2-4
2.2.4 Screw holes.....	2-4
2.3 Central Processing Unit (CPU) .....	2-5
2.3.1 Installing the CPU .....	2-5
2.3.2 Installing the CPU heatsink and fan.....	2-8
2.3.3 Uninstalling the CPU heatsink and fan.....	2-9
2.4 System memory .....	2-10
2.4.1 Overview .....	2-10
2.4.2 Memory configurations.....	2-11
2.4.3 Installing a DIMM .....	2-17
2.4.4 Removing a DIMM .....	2-17
2.5 Expansion slots.....	2-18
2.5.1 Installing an expansion card.....	2-18
2.5.2 Configuring an expansion card .....	2-18
2.5.3 Interrupt assignments.....	2-19
2.5.4 PCI slots.....	2-20
2.5.5 PCI Express x1 slot.....	2-20
2.5.6 PCI Express 2.0 x16 slots.....	2-20
2.6 Jumpers.....	2-22
2.7 Onboard switches .....	2-23

# Contents

- 2.8 Connectors ..... 2-25**
  - 2.8.1 Rear panel connectors ..... 2-25
  - 2.8.2 Audio I/O connections ..... 2-26
  - 2.8.3 Internal connectors ..... 2-29
  - 2.8.4 ASUS Q-Connector (system panel) ..... 2-37
- 2.9 Starting up for the first time ..... 2-38**
- 2.10 Turning off the computer ..... 2-38**
  
- Chapter 3: BIOS setup**
  - 3.1 Knowing BIOS ..... 3-1**
  - 3.2 Updating BIOS ..... 3-1**
    - 3.2.1 ASUS Update utility ..... 3-2
    - 3.2.2 ASUS EZ Flash 2 utility ..... 3-4
    - 3.2.3 ASUS CrashFree BIOS 3 utility ..... 3-5
  - 3.3 BIOS setup program ..... 3-6**
    - 3.3.1 BIOS menu screen ..... 3-6
    - 3.3.2 Menu bar ..... 3-6
    - 3.3.3 Navigation keys ..... 3-7
    - 3.3.4 Menu items ..... 3-7
    - 3.3.5 Submenu items ..... 3-7
    - 3.3.6 Configuration fields ..... 3-7
    - 3.3.7 Pop-up window ..... 3-7
    - 3.3.8 Scroll bar ..... 3-7
    - 3.3.9 General help ..... 3-7
  - 3.4 Main menu ..... 3-8**
    - 3.4.1 SATA 1–6 ..... 3-8
    - 3.4.2 Storage Configuration ..... 3-10
    - 3.4.3 AHCI Configuration ..... 3-11
    - 3.4.4 System Information ..... 3-11
  - 3.5 Ai Tweaker menu ..... 3-12**
    - 3.5.1 Ai Overclock Tuner ..... 3-12
    - 3.5.2 CPU Ratio Setting ..... 3-13
    - 3.5.3 Intel(R) SpeedStep(TM) Tech ..... 3-13
    - 3.5.4 Intel(R) TurboMode Tech ..... 3-13
    - 3.5.5 Xtreme Phase Full Power Mode ..... 3-13
    - 3.5.6 BCLK Frequency ..... 3-13
    - 3.5.8 DRAM Frequency ..... 3-14
    - 3.5.9 UCLK Frequency ..... 3-14
    - 3.5.10 QPI Link Data Rate ..... 3-14
    - 3.5.11 DRAM Timing Control ..... 3-14

# Contents

3.5.7	PCIe Frequency.....	3-14
3.5.12	CPU Voltage Control.....	3-16
3.5.13	CPU Voltage.....	3-16
3.5.14	CPU PLL Voltage.....	3-16
3.5.15	QPI/DRAM Core Voltage.....	3-16
3.5.16	IOH Voltage.....	3-17
3.5.17	IOH PCIe Voltage.....	3-17
3.5.18	ICH Voltage.....	3-17
3.5.19	ICH PCIe Voltage.....	3-17
3.5.20	DRAM Bus Voltage.....	3-17
3.5.21	DRAM DATA REF Voltage on CHA/B/C.....	3-18
3.5.22	DRAM CTRL REF Voltage on CHA/B/C.....	3-18
3.5.23	Load-Line Calibration.....	3-18
3.5.24	CPU Differential Amplitude.....	3-18
3.5.25	CPU Clock Skew.....	3-18
3.5.26	CPU Spread Spectrum.....	3-18
3.5.27	IOH Clock Skew.....	3-18
3.5.28	PCIe Spread Spectrum.....	3-18
<b>3.6</b>	<b>Advanced menu.....</b>	<b>3-19</b>
3.6.1	CPU Configuration.....	3-19
3.6.2	Chipset.....	3-22
3.6.3	Onboard Devices Configuration.....	3-22
3.6.4	USB Configuration.....	3-24
3.6.5	PCIPnP.....	3-25
<b>3.7</b>	<b>Power menu.....</b>	<b>3-26</b>
3.7.1	Suspend Mode.....	3-26
3.7.2	Repost Video on S3 Resume.....	3-26
3.7.3	ACPI 2.0 Support.....	3-26
3.7.4	ACPI APIC Support.....	3-26
3.7.5	EuP Ready.....	3-26
3.7.6	APM Configuration.....	3-27
3.7.7	Hardware Monitor.....	3-28
<b>3.8</b>	<b>Boot menu.....</b>	<b>3-29</b>
3.8.1	Boot Device Priority.....	3-29
3.8.2	Boot Settings Configuration.....	3-30
3.8.3	Security.....	3-31
<b>3.9</b>	<b>Tools menu.....</b>	<b>3-33</b>
3.9.1	ASUS EZ Flash 2.....	3-33
3.9.2	Express Gate.....	3-34
3.9.3	ASUS O.C. Profile.....	3-35

# Contents

3.9.4	AI NET 2.....	3-36
<b>3.10</b>	<b>Exit menu.....</b>	<b>3-37</b>

## **Chapter 4: Software support**

<b>4.1</b>	<b>Installing an operating system .....</b>	<b>4-1</b>
<b>4.2</b>	<b>Support DVD information.....</b>	<b>4-1</b>
4.2.1	Running the support DVD.....	4-1
4.2.2	Obtaining the software manuals.....	4-2
<b>4.3</b>	<b>Software information .....</b>	<b>4-3</b>
4.3.1	ASUS PC Probe II.....	4-3
4.3.2	ASUS AI Suite.....	4-4
4.3.3	ASUS EPU.....	4-5
4.3.4	ASUS Fan Xpert.....	4-6
4.3.5	ASUS TurboV.....	4-7
4.3.6	ASUS Express Gate SSD.....	4-8
4.3.7	Audio configurations.....	4-9
<b>4.4</b>	<b>RAID configurations .....</b>	<b>4-10</b>
4.4.1	RAID definitions .....	4-10
4.4.2	Installing Serial ATA hard disks .....	4-11
4.4.3	Setting the RAID item in BIOS .....	4-11
4.4.4	Intel® Matrix Storage Manager option ROM utility.....	4-11
<b>4.5</b>	<b>Creating a RAID driver disk.....</b>	<b>4-15</b>
4.5.1	Creating a RAID driver disk without entering the OS.....	4-15
4.5.2	Creating a RAID driver disk in Windows®.....	4-15
4.5.3	Installing the RAID driver during Windows® OS installation.....	4-16
4.5.4	Using a USB floppy disk drive.....	4-17

## **Chapter 5: Multiple GPU technology support**

<b>5.1</b>	<b>ATI® CrossFireX™ technology .....</b>	<b>5-1</b>
5.1.1	Requirements.....	5-1
5.1.2	Before you begin.....	5-1
5.1.3	Installing two CrossFireX™ graphics cards .....	5-2
5.1.4	Installing three CrossFireX™ graphics cards.....	5-3
5.1.5	Installing the device drivers.....	5-4
5.1.6	Enabling the ATI® CrossFireX™ technology .....	5-4
<b>5.2</b>	<b>NVIDIA® SLI™ technology.....</b>	<b>5-6</b>
5.2.1	Requirements.....	5-6
5.2.2	Installing two SLI-ready graphics cards .....	5-7
5.2.3	Installing three SLI-ready graphics cards.....	5-8
5.2.4	Installing the device drivers.....	5-9
5.2.5	Enabling the NVIDIA® SLI™ technology .....	5-9

# Notices

## Federal Communications Commission Statement

This device complies with Part 15 of the FCC Rules. Operation is subject to the following two conditions:

- This device may not cause harmful interference, and
- This device must accept any interference received including interference that may cause undesired operation.

This equipment has been tested and found to comply with the limits for a Class B digital device, pursuant to Part 15 of the FCC Rules. These limits are designed to provide reasonable protection against harmful interference in a residential installation. This equipment generates, uses and can radiate radio frequency energy and, if not installed and used in accordance with manufacturer's instructions, may cause harmful interference to radio communications. However, there is no guarantee that interference will not occur in a particular installation. If this equipment does cause harmful interference to radio or television reception, which can be determined by turning the equipment off and on, the user is encouraged to try to correct the interference by one or more of the following measures:

- Reorient or relocate the receiving antenna.
- Increase the separation between the equipment and receiver.
- Connect the equipment to an outlet on a circuit different from that to which the receiver is connected.
- Consult the dealer or an experienced radio/TV technician for help.



---

The use of shielded cables for connection of the monitor to the graphics card is required to assure compliance with FCC regulations. Changes or modifications to this unit not expressly approved by the party responsible for compliance could void the user's authority to operate this equipment.

---

## Canadian Department of Communications Statement

This digital apparatus does not exceed the Class B limits for radio noise emissions from digital apparatus set out in the Radio Interference Regulations of the Canadian Department of Communications.

This class B digital apparatus complies with Canadian ICES-003.

## REACH

Complying with the REACH (Registration, Evaluation, Authorisation, and Restriction of Chemicals) regulatory framework, we published the chemical substances in our products at ASUS REACH website at <http://green.asus.com/english/REACH.htm>.



---

**DO NOT** throw the motherboard in municipal waste. This product has been designed to enable proper reuse of parts and recycling. This symbol of the crossed out wheeled bin indicates that the product (electrical and electronic equipment) should not be placed in municipal waste. Check local regulations for disposal of electronic products.

---



---

**DO NOT** throw the mercury-containing button cell battery in municipal waste. This symbol of the crossed out wheeled bin indicates that the battery should not be placed in municipal waste.

---

# Safety information

## Electrical safety

- To prevent electrical shock hazard, disconnect the power cable from the electrical outlet before relocating the system.
- When adding or removing devices to or from the system, ensure that the power cables for the devices are unplugged before the signal cables are connected. If possible, disconnect all power cables from the existing system before you add a device.
- Before connecting or removing signal cables from the motherboard, ensure that all power cables are unplugged.
- Seek professional assistance before using an adapter or extension cord. These devices could interrupt the grounding circuit.
- Ensure that your power supply is set to the correct voltage in your area. If you are not sure about the voltage of the electrical outlet you are using, contact your local power company.
- If the power supply is broken, do not try to fix it by yourself. Contact a qualified service technician or your retailer.

## Operation safety

- Before installing the motherboard and adding devices on it, carefully read all the manuals that came with the package.
- Before using the product, ensure all cables are correctly connected and the power cables are not damaged. If you detect any damage, contact your dealer immediately.
- To avoid short circuits, keep paper clips, screws, and staples away from connectors, slots, sockets and circuitry.
- Avoid dust, humidity, and temperature extremes. Do not place the product in any area where it may become wet.
- Place the product on a stable surface.
- If you encounter technical problems with the product, contact a qualified service technician or your retailer.



# About this guide

This user guide contains the information you need when installing and configuring the motherboard.

## How this guide is organized

This guide contains the following parts:

- **Chapter 1: Product introduction**  
This chapter describes the features of the motherboard and the new technology it supports.
- **Chapter 2: Hardware information**  
This chapter lists the hardware setup procedures that you have to perform when installing system components. It includes description of the switches, jumpers, and connectors on the motherboard.
- **Chapter 3: BIOS setup**  
This chapter tells how to change system settings through the BIOS Setup menus. Detailed descriptions of the BIOS parameters are also provided.
- **Chapter 4: Software support**  
This chapter describes the contents of the support DVD that comes with the motherboard package and the software.
- **Chapter 5: Multiple GPU technology support**  
This chapter describes how to install and configure multiple ATI® CrossFireX™ and NVIDIA® SLI™ graphics cards.

## Where to find more information

Refer to the following sources for additional information and for product and software updates.

1. **ASUS websites**  
The ASUS website provides updated information on ASUS hardware and software products. Refer to the ASUS contact information.
2. **Optional documentation**  
Your product package may include optional documentation, such as warranty flyers, that may have been added by your dealer. These documents are not part of the standard package.

## Conventions used in this guide

To ensure that you perform certain tasks properly, take note of the following symbols used throughout this manual.



**DANGER/WARNING:** Information to prevent injury to yourself when trying to complete a task.



**CAUTION:** Information to prevent damage to the components when trying to complete a task.



**IMPORTANT:** Instructions that you **MUST** follow to complete a task.



**NOTE:** Tips and additional information to help you complete a task.

## Typography

### **Bold text**

Indicates a menu or an item to select.

### *Italics*

Used to emphasize a word or a phrase.

### <Key>

Keys enclosed in the less-than and greater-than sign means that you must press the enclosed key.

Example: <Enter> means that you must press the Enter or Return key.

### <Key1> + <Key2> + <Key3>

If you must press two or more keys simultaneously, the key names are linked with a plus sign (+).

Example: <Ctrl> + <Alt> + <Del>

## P6X58D Premium specifications summary

<b>CPU</b>	LGA1366 socket for Intel® Core™ i7 Processor Extreme Edition / Core™ i7 Processor Supports Intel® Turbo Boost Technology * Refer to <a href="http://www.asus.com">www.asus.com</a> for Intel CPU support list
<b>Chipset</b>	Intel® X58 / ICH10R
<b>System bus</b>	Up to 6.4GT/s; Intel® QuickPath Interconnect
<b>Memory</b>	6 x DIMM, max. 24GB, DDR3 2000(O.C.) / 1866(O.C.) / 1800(O.C.) / 1600(O.C.) / 1333 / 1066 MHz, non-ECC, un-buffered memory Triple channel memory architecture Supports Intel® Extreme Memory Profile (XMP) * Hyper DIMM support is subject to the physical characteristics of individual CPUs. ** Refer to <a href="http://www.asus.com">www.asus.com</a> or this user manual for the Memory QVL (Qualified Vendors Lists)
<b>Expansion slots</b>	3 x PCI Express 2.0 x16 slots (at x16/x8/x8 or x16/x16/x1 mode) 1 x PCI Express x1 slot 2 x PCI slots
<b>Multi-GPU support</b>	Supports NVIDIA® 3-Way SLI™ Technology Supports ATI® Quad-GPU CrossFireX™ Technology
<b>Storage</b>	<b>Intel® ICH10R Southbridge</b> <ul style="list-style-type: none"> <li>- 6 x SATA 3.0 Gb/s ports</li> <li>- Intel® Matrix Storage Technology supports SATA RAID 0, 1, 5, and 10</li> </ul> <b>Marvell® 88SE9123 SATA 6.0 Gb/s controller</b> <ul style="list-style-type: none"> <li>- 2 x SATA 6.0 Gb/s ports</li> </ul>
<b>LAN</b>	Dual Gigabit LAN controllers 2 x Marvell® 88E8056 PCIe Gigabit LAN controller featuring AI NET2
<b>Audio</b>	Realtek® ALC889 8-channel High Definition Audio CODEC <ul style="list-style-type: none"> <li>- DTS Surround Sensation UltraPC</li> <li>- BD audio layer Content Protection</li> <li>- Supports Jack-Detection, Multi-streaming, and Front Panel Jack-Retasking</li> <li>- Coaxial / Optical S/PDIF out ports at back I/O</li> </ul>
<b>IEEE 1394</b>	VIA® VT6308 controller supports 2 x IEEE 1394a ports (one at midboard; one at back panel)
<b>USB</b>	<b>NEC® USB 3.0 controller</b> <ul style="list-style-type: none"> <li>- 2 x USB 3.0/2.0 ports (at back panel)</li> </ul> <b>Intel® ICH10R Southbridge</b> <ul style="list-style-type: none"> <li>- 8 x USB 2.0/1.1 ports (4 ports at midboard; 4 ports at back panel)</li> </ul>

(continued on the next page)

# P6X58D Premium specifications summary

<b>ASUS unique features</b>	<p><b>ASUS Xtreme Design</b></p> <p><b>ASUS Xtreme Phase:</b></p> <ul style="list-style-type: none"><li>- ASUS 16+2 Phase Power Design</li></ul> <p><b>ASUS Exclusive Overclocking Features</b></p> <ul style="list-style-type: none"><li>- ASUS TurboV</li></ul> <p><b>ASUS Exclusive Features</b></p> <ul style="list-style-type: none"><li>- MemOK!</li><li>- ASUS EPU</li><li>- Express Gate SSD</li></ul> <p><b>ASUS Quiet Thermal Solutions</b></p> <ul style="list-style-type: none"><li>- ASUS Fanless Design: Heat-pipe solution</li><li>- ASUS Fanless Design: Stack Cool 3+</li><li>- ASUS Fan Xpert</li></ul> <p><b>ASUS Crystal Sound</b></p> <ul style="list-style-type: none"><li>- ASUS Noise Filter</li></ul> <p><b>ASUS EZ DIY</b></p> <ul style="list-style-type: none"><li>- ASUS Q-Slot</li><li>- ASUS Q-Shield</li><li>- ASUS Q-Connector</li><li>- ASUS O.C. Profile</li><li>- ASUS CrashFree BIOS 3</li><li>- ASUS EZ Flash 2</li><li>- ASUS MyLogo 2™</li><li>- Multi-language BIOS</li></ul>
<b>ASUS exclusive overclocking features</b>	<p><b>ASUS TurboV utility</b></p> <p><b>Precision Tweaker 2</b></p> <ul style="list-style-type: none"><li>- vCore: Adjustable CPU voltage at 0.00625V increment</li><li>- vCPU PLL: 36-step reference voltage control</li><li>- vDRAM Bus: 49-step DRAM voltage control</li><li>- vChipset(N.B.): 31-step chipset voltage control</li><li>- vNB-PCIe: 65-step chipset-PCIe voltage control</li></ul> <p><b>SFS (Stepless Frequency Selection)</b></p> <ul style="list-style-type: none"><li>- Internal Base Clock tuning from 100MHz up to 500 MHz at 1MHz increment</li><li>- PCI Express frequency tuning from 100MHz up to 180MHz at 1MHz increment</li></ul> <p><b>Overclocking protection</b></p> <ul style="list-style-type: none"><li>- ASUS C.P.R. (CPU Parameter Recall)</li></ul>

*(continued on the next page)*

## P6X58D Premium specifications summary

<b>Back panel I/O ports</b>	<ul style="list-style-type: none"> <li>1 x PS/2 keyboard port (purple)</li> <li>1 x PS/2 mouse port (green)</li> <li>1 x Clear CMOS button</li> <li>1 x Coaxial S/PDIF Out port</li> <li>1 x Optical S/PDIF Out port</li> <li>1 x IEEE 1394a port</li> <li>2 x LAN (RJ-45) ports</li> <li>2 x USB 3.0/2.0 ports</li> <li>4 x USB 2.0/1.1 ports</li> <li>8-channel Audio I/O ports</li> </ul>
<b>Internal I/O connectors</b>	<ul style="list-style-type: none"> <li>2 x USB connectors support additional 4 USB 2.0/1.1 ports</li> <li>2 x SATA 6.0 Gb/s connectors (gray)</li> <li>6 x SATA 3.0 Gb/s connectors (blue)</li> <li>1 x CPU Fan connector</li> <li>3 x Chassis Fan connectors (1 x 4-pin, 2 x 3-pin)</li> <li>1 x Power Fan connector</li> <li>1 x IEEE1394a connector</li> <li>Front panel audio connector</li> <li>1 x S/PDIF Out header</li> <li>CD audio in</li> <li>24-pin ATX Power connector</li> <li>8-pin ATX 12V Power connector</li> <li>System Panel (Q-Connector)</li> <li>1 x MemOK! button</li> <li>1 x Power on switch</li> <li>1 x Reset switch</li> </ul>
<b>BIOS features</b>	<ul style="list-style-type: none"> <li>16 Mb Flash ROM, AMI BIOS, PnP, DMI 2.0, WfM 2.0,</li> <li>SM BIOS 2.3, ACPI 2.0a, Multi-language BIOS,</li> <li>ASUS EZ Flash 2, ASUS CrashFree BIOS 3</li> </ul>
<b>Manageability</b>	<ul style="list-style-type: none"> <li>WfM 2.0, DMI 2.0, WOL by PME, WOR by PME, PXE</li> </ul>
<b>Support DVD contents</b>	<ul style="list-style-type: none"> <li>Drivers</li> <li>ASUS Utilities</li> <li>ASUS Update</li> <li>Anti-virus software (OEM version)</li> </ul>
<b>Form factor</b>	<ul style="list-style-type: none"> <li>ATX form factor: 12 in. x 9.6 in. (30.5 cm x 24.4 cm)</li> </ul>

\*Specifications are subject to change without notice.



# Chapter 1

## 1.1 Welcome!







Thank you for buying an ASUS® P6X58D Premium motherboard!

The motherboard delivers a host of new features and latest technologies, making it another standout in the long line of ASUS quality motherboards!

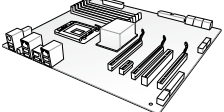
Before you start installing the motherboard, and hardware devices on it, check the items in your package with the list below.

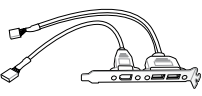
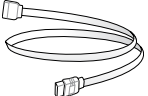
## 1.2 Package contents

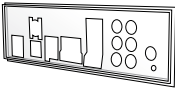
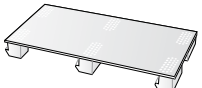
Check your motherboard package for the following items.

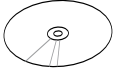
	
1 x ASUS P6X58D Premium motherboard	1 x ASUS SLI™ bridge cable
	
1 x 2-port USB 2.0 and 1-port eSATA module	2 x Serial ATA 6.0 Gb/s cables 4 x Serial ATA 3.0 Gb/s cables
	
1 x 2-in-1 ASUS Q-Connector kit	1 x ASUS Q-Shield
	
1 x ASUS 3-Way SLI™ bridge connector	1 x Optional Fan for water-cooling or passive-cooling only
	
1 x User guide	1 x Support DVD



- If any of the above items is damaged or missing, contact your retailer.
- The illustrated items above are for reference only. Actual product specifications may vary with different models.

## 1.3 Special features

### 1.3.1 Product highlights

#### Intel® Core™ i7 Processor Extreme Edition / Core™ i7 Processor support

This motherboard supports the latest Intel® Core™ i7 processors in LGA1366 package with integrated memory controller to support 3-channel (6 DIMMs) DDR3 memory. Supports Intel® QuickPath Interconnect (QPI) with a system bus of up to 6.4 GT/s and a max bandwidth of up to 25.6 GB/s. Intel® Core™ i7 processor is one of the most powerful and energy efficient CPUs in the world. Refer to page 2-5 for details.

#### Intel® X58 Chipset

The Intel® X58 Express Chipset is one of the most powerful chipset designed to support the Intel® Core™ i7 Processors with LGA1366 package and Intel® next generation system interconnect interface, Intel® QuickPath Interconnect (QPI), providing improved performance by utilizing serial point-to-point links, allowing increased bandwidth and stability. It also supports up to 36 PCI Express 2.0 lanes providing better graphics performance.

#### Triple-Channel DDR3 2000(O.C.) / 1866(O.C.) / 1800(O.C.) / 1600(O.C.) / 1333 / 1066 support

The motherboard supports DDR3 memory that features data transfer rates of 2000(O.C.) / 1866(O.C.) / 1800(O.C.) / 1600(O.C.) / 1333 / 1066 MHz to meet the higher bandwidth requirements of the latest 3D graphics, multimedia, and Internet applications. The triple-channel DDR3 architecture enlarges the bandwidth of your system memory to boost system performance. Refer to page 2-10 for details.

#### 3-Way SLI™ and Quad-GPU CrossFireX™ support

The P6X58D Premium breaks the boundaries to bring you the multi-GPU choice of either SLI™ or CrossFireX™. The motherboard features a dedicated graphics engine on the most powerful Intel® X58 platform to optimize PCIe allocation in multiple GPU configurations. Expect a brand-new gaming style you've never experienced before! Refer to chapter 5 for details.

#### True USB 3.0 Support

Experience ultra-fast data transfers at 4.8 Gb/s with USB 3.0—the latest connectivity standard. Built to connect easily with next-generation components and peripherals, USB 3.0 transfers data 10X faster and is also backward compatible with USB 2.0 components.

#### True Serial ATA 6.0 Gb/s support

Supporting the next-generation Serial ATA (SATA) storage interface, this motherboard delivers up to 6.0 Gb/s data transfer rates. Additionally, get enhanced scalability, faster data retrieval, double the bandwidth of current bus systems. Refer to page 2-30 for details.

#### Green ASUS

This motherboard and its packaging comply with the European Union's Restriction on the use of Hazardous Substances (RoHS). This is in line with the ASUS vision of creating environment-friendly and recyclable products/packaging to safeguard consumers' health while minimizing the impact on the environment.



## 1.3.2 ASUS unique features

### ASUS Xtreme Design

#### ASUS Xtreme Phase

##### ASUS True 16+2 Phase Power Design

The groundbreaking 16+2 phase VRM design is brought to the ASUS motherboards. 16+2 phase power design, 16-phase for vCore and extra 2-phase for QPI/Memory controller inside CPU, can provide the highest power efficiency, and hence generates less heat to effectively enhance the overclocking capability. With the high quality power components such as low RDS (on) MOSFETs, Ferrite core chokes with lower hysteresis loss, and 100% Japan-made high quality conductive polymer capacitors, ASUS 16+2 phase VRM design also ensure longer component life and minimum power loss.

#### ASUS Exclusive Features

##### MemOK!

Memory compatibility is among the top concerns during computer upgrades. Worry no more. MemOK! is the fastest memory booting solution today. This remarkable memory rescue tool requires nothing but a push of a button to patch memory issues and get your system up and running in no time. The technology is able to determine failsafe settings that can dramatically improve your system booting success. Refer to page 2-24 for details.

##### ASUS EPU

The ASUS EPU (Energy Processing Unit) provides total system power management by detecting current PC loadings and intelligently moderating power usage for critical PC components in real-time—helping save power and money!

##### Express Gate SSD

Express Gate™ is an ASUS exclusive OS that provides you with quick access to the Internet and key applications before entering the Windows® OS. Refer to pages 3-34 and 4-8 for details.

#### ASUS Quiet Thermal Solutions

ASUS Quiet Thermal solutions make the system more stable and enhance the overclocking capability.

##### Fanless Design—Heat-pipe solution

The Heat Pipe design effectively directs the heat generated by the chipsets to the heatsink near the back IO ports, where it can be carried away by existing airflow from CPU fan or bundled optional fan. The purpose of the innovative heat pipe design on this motherboard is that the groundbreaking fanless design does not have lifetime problems as a chipset fan does. Furthermore, it provides options for users to install side-flow fan or passive cooler. The Heat Pipe design is the most reliable fanless thermal solution to date.



---

DO NOT uninstall the heat-pipe by yourself. Doing so may bend the tubing and affect the heat dissipation performance.

---

**Up to 20°C (36°F) Cooler—Stack Cool 3+**

Stack Cool 3+ is a fanless cooling solution offered exclusively by ASUS. It effectively and noiselessly transfers heat generated by the critical components to the other side of the specially designed PCB (printed circuit board) for effective heat dissipation—making temperatures cooler by up to 20°C.

**Fan Xpert**

ASUS Fan Xpert intelligently allows you to adjust both the CPU and chassis fan speeds according to different ambient temperatures caused by different climate conditions in different geographic regions and your PC's loading. The built-in variety of useful profiles offer flexible controls of fan speed to achieve a quiet and cool environment. Refer to page 4-6 for details.

**ASUS Crystal Sound**

This feature can enhance speech-centric applications like Skype, online game, video conference and recording.

**Noise Filter**

This feature detects repetitive and stationary noises (non-voice signals) like computer fans, air conditioners, and other background noises then eliminates it in the incoming audio stream while recording.

**DTS Surround Sensation UltraPC**

DTS Surround Sensation UltraPC delivers exceptional 5.1 surround experience through the most common PC audio setups—your existing stereo speakers or headphones. In addition to virtual surround, “Bass enhancement” provides stronger low frequency bass sound, and “Voice clarification” provides clear human dialogue even with loud background sound. With these technologies, you may experience a better home-theater audio with ease.

**ASUS EZ DIY**

ASUS EZ DIY feature collection provides you with easy ways to install computer components, update the BIOS, or back up your favorite settings.

**ASUS Onboard Switch**

With an easy press during overclocking, the exclusive onboard switches allow gamers to effortless fine-tune the performance without having to short the pins! Refer to page 2-23 for details.

**ASUS Q-Slot**

ASUS Q-Slot enhances your DIY experience that speeds up and simplifies the DIY process!

**ASUS Q-Shield**

ASUS Q-Shield's special design makes it convenient and easy to install on your motherboard. With better electric conductivity, it ideally protects your motherboard against static electricity and shields it against Electronic Magnetic Interference (EMI).

### **ASUS Q-Connector**

ASUS Q-Connector allows you to easily connect or disconnect the chassis front panel cables to the motherboard. This unique module eliminates the trouble of connecting the system panel cables one at a time and avoiding wrong cable connections.

### **ASUS O.C. Profile**

The motherboard features the ASUS O.C. Profile that allows you to conveniently store or load multiple BIOS settings. The BIOS settings can be stored in the CMOS or a separate file, giving you the freedom to share and distribute your favorite settings.

### **ASUS CrashFree BIOS 3**

ASUS CrashFree BIOS 3 allows you to restore corrupted BIOS data from a USB flash disk containing the BIOS file. This protection eliminates the need to buy a replacement ROM chip.

### **ASUS EZ Flash 2**

ASUS EZ Flash 2 is a user-friendly utility that allows you to update the BIOS without using a bootable floppy disk or an OS-based utility.

### **ASUS MyLogo2™**

This feature allows you to convert your favorite photo into a 256-color boot logo for a more colorful and vivid image on your screen.

### **Multi-language BIOS**

The multi-language BIOS allows you to select the language of your choice from the available options. The localized BIOS setup menu helps you configure your system easier and faster.

## **1.3.3 ASUS exclusive overclocking features**

### **ASUS TurboV**

Feel the adrenaline rush of real-time OC—now a reality with the ASUS TurboV. This easy OC tool allows you to overclock without exiting or rebooting the OS; and its user-friendly interface makes overclock with just a few clicks away. Moreover, the ASUS OC profiles in TurboV provides the best O.C. settings in different scenarios.

### **Precision Tweaker 2**

Allows you to adjust the CPU voltage in 0.00625v steps and NB/DRAM voltage in 0.02v steps to fine-tune voltage to achieve the most precise setting for the ultimate overclocking configuration.

### **C.P.R. (CPU Parameter Recall)**

The BIOS C.P.R. feature automatically restores the CPU default settings when the system hangs due to overclocking failure. C.P.R. eliminates the need to open the system chassis and clear the RTC data. Simply shut down and reboot the system, and the BIOS automatically restores the CPU parameters to their default settings.



## 2.1 Before you proceed

Take note of the following precautions before you install motherboard components or change any motherboard settings.



- 
- Unplug the power cord from the wall socket before touching any component.
  - Before handling components, use a grounded wrist strap or touch a safely grounded object or a metal object, such as the power supply case, to avoid damaging them due to static electricity.
  - Hold components by the edges to avoid touching the ICs on them.
  - Whenever you uninstall any component, place it on a grounded antistatic pad or in the bag that came with the component.
  - Before you install or remove any component, ensure that the ATX power supply is switched off or the power cord is detached from the power supply. Failure to do so may cause severe damage to the motherboard, peripherals, or components.
-

## 2.2 Motherboard overview

### 2.2.1 Motherboard layout

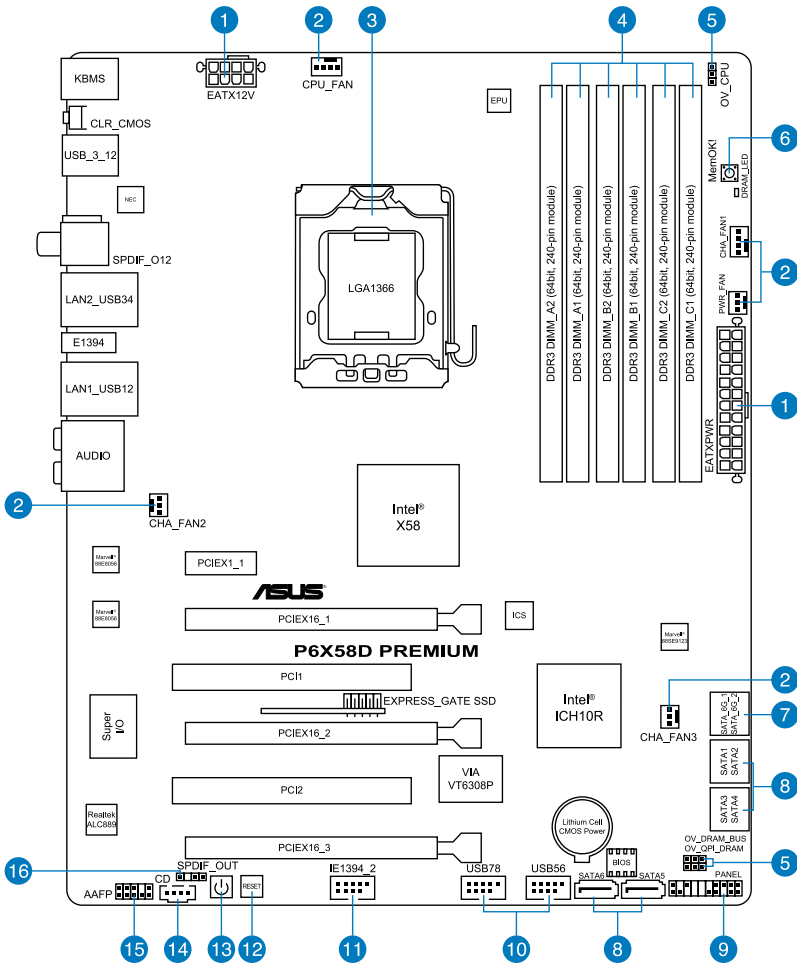

Refer to **2.8 Connectors** for more information about rear panel connectors and internal connectors.

## 2.2.2 Layout contents

Connectors/Jumpers/Slots	Page
1. ATX power connectors (24-pin EATXPWR, 8-pin EATX12V)	2-35
2. CPU, chassis, and power fan connectors (4-pin CPU_FAN, 4-pin CHA_FAN1 3-pin CHA_FAN2-3, 3-pin PWR_FAN)	2-33
3. LGA1366 CPU Socket	2-5
4. DDR3 DIMM slots	2-10
5. CPU / DRAM Bus / QPI DRAM overvoltage settings (3-pin OV_CPU; 3-pin OV_DRAM_BUS; 3-pin OV_QPI_DRAM)	2-22
6. MemOK! switch (MEMOK)	2-24
7. Marvell® Serial ATA 6.0 Gb/s connectors (7-pin SATA_6G_1, 7-pin SATA_6G_2 [gray])	2-30
8. ICH10R Serial ATA 3.0 Gb/s connectors (7-pin SATA1-6 [blue])	2-29
9. System panel connector (20-8 pin PANEL)	2-36
10. USB connectors (10-1 pin USB56, USB78)	2-31
11. IEEE 1394a port connector (10-1 pin IE1394_2)	2-32
12. Onboard Reset switch	2-23
13. Onboard Power-on switch	2-23
14. Optical drive audio connector (4-pin CD)	2-32
15. Front panel audio connector (10-1 pin AAFP)	2-34
16. Digital audio connector (4-1 pin SPDIF_OUT)	2-34

### 2.2.3 Placement direction

When installing the motherboard, ensure that you place it into the chassis in the correct orientation. The edge with external ports goes to the rear part of the chassis as indicated in the image below.

### 2.2.4 Screw holes

Place nine screws into the holes indicated by circles to secure the motherboard to the chassis.



DO NOT overtighten the screws! Doing so can damage the motherboard.

Place this side towards the rear of the chassis

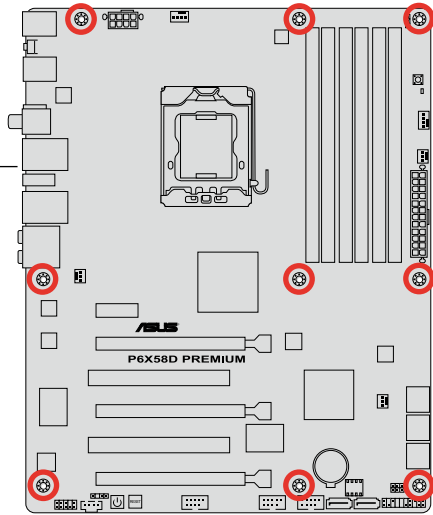



## 2.3 Central Processing Unit (CPU)

The motherboard comes with a surface mount LGA1366 socket designed for the Intel® Core™ i7 Processor Extreme Edition / Core™ i7 Processor.



Ensure that all power cables are unplugged before installing the CPU.



- Upon purchase of the motherboard, ensure that the PnP cap is on the socket and the socket contacts are not bent. Contact your retailer immediately if the PnP cap is missing, or if you see any damage to the PnP cap/socket contacts/motherboard components. ASUS will shoulder the cost of repair only if the damage is shipment/transit-related.
- Keep the cap after installing the motherboard. ASUS will process Return Merchandise Authorization (RMA) requests only if the motherboard comes with the cap on the LGA1366 socket.
- The product warranty does not cover damage to the socket contacts resulting from incorrect CPU installation/removal, or misplacement/loss/incorrect removal of the PnP cap.

### 2.3.1 Installing the CPU

To install a CPU:

1. Locate the CPU socket on the motherboard.

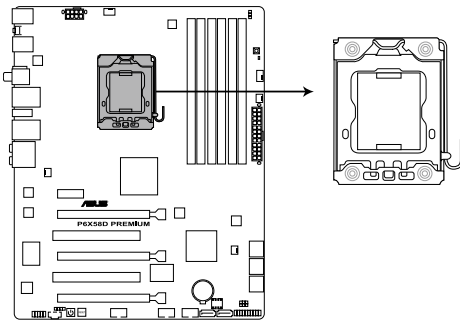

**P6X58D PREMIUM CPU LGA1366 socket**



Before installing the CPU, ensure that the cam box is facing towards you and the load lever is on your left.

2. Press the load lever with your thumb (A), then move it to the left (B) until it is released from the retention tab.



To prevent damage to the socket pins, do not remove the PnP cap unless you are installing a CPU.

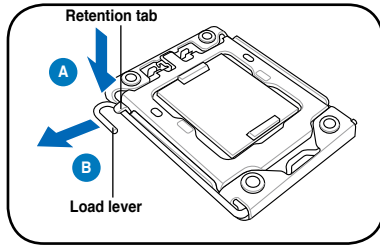

3. Lift the load lever in the direction of the arrow to a 135° angle.
4. Lift the load plate with your thumb and forefinger to a 100° angle.

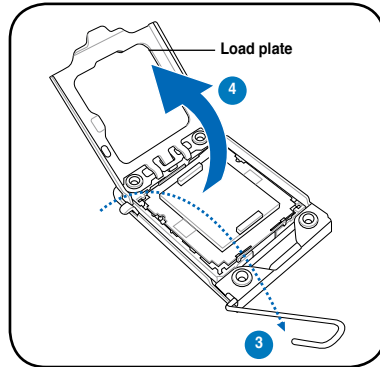

5. Remove the PnP cap from the CPU socket.

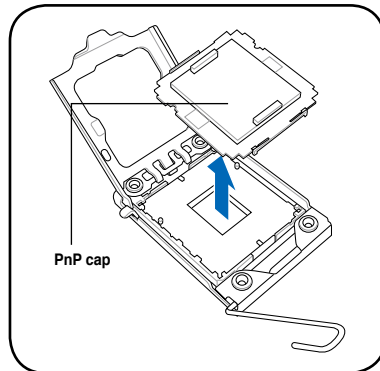

6. Position the CPU over the socket, ensuring that the gold triangle is on the bottom-left corner of the socket, and then fit the socket alignment key into the CPU notch.



The CPU fits in only one correct orientation. **DO NOT** force the CPU into the socket to prevent bending the connectors on the socket and damaging the CPU!

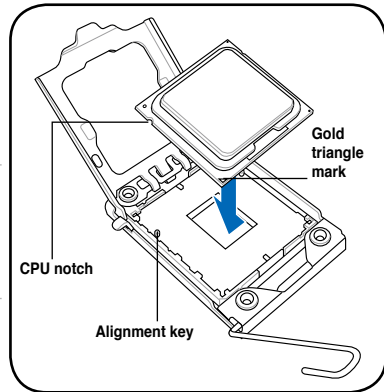

7. Apply some Thermal Interface Material to the exposed area of the CPU that the heatsink will be in contact with, ensuring that it is spread in an even thin layer.



Some heatsinks come with pre-applied thermal paste. If so, skip this step.



The Thermal Interface Material is toxic and inedible. **DO NOT** eat it. If it gets into your eyes or touches your skin, wash it off immediately, and seek professional medical help.

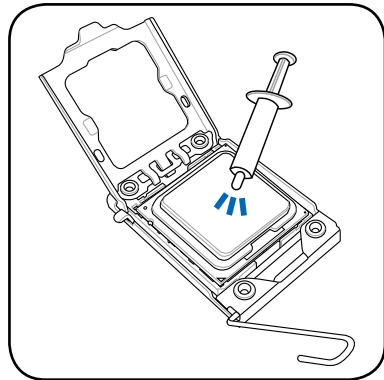

To prevent contaminating the paste, **DO NOT** spread the paste with your finger directly.

8. Close the load plate (A), then push the load lever (B) until it snaps into the retention tab.

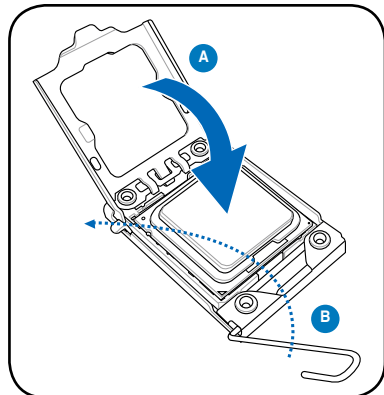

## 2.3.2 Installing the CPU heatsink and fan

The Intel® LGA1366 processor requires a specially designed heatsink and fan assembly to ensure optimum thermal condition and performance.



- When you buy a boxed Intel® processor, the package includes the CPU fan and heatsink assembly. If you buy a CPU separately, ensure that you use only Intel®-certified multi-directional heatsink and fan.
- Your Intel® LGA1366 heatsink and fan assembly comes in a push-pin design and requires no tool to install.



If you purchased a separate CPU heatsink and fan assembly, ensure that the Thermal Interface Material is properly applied to the CPU heatsink or CPU before you install the heatsink and fan assembly.



Ensure that you have installed the motherboard to the chassis before you install the CPU fan and heatsink assembly.

To install the CPU heatsink and fan:

1. Place the heatsink on top of the installed CPU, ensuring that the four fasteners match the holes on the motherboard.
2. Push down two fasteners at a time in a diagonal sequence to secure the heatsink and fan assembly in place.

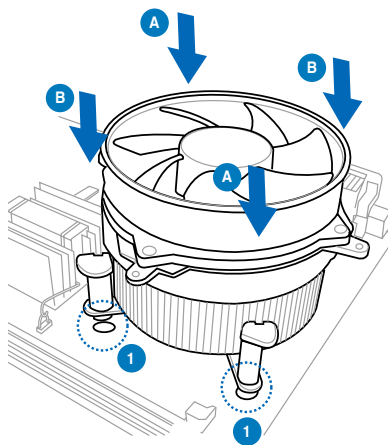
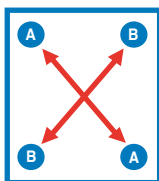

Orient the heatsink and fan assembly such that the CPU fan cable is closest to the CPU fan connector.

3. Connect the CPU fan cable to the connector on the motherboard labeled CPU\_FAN.

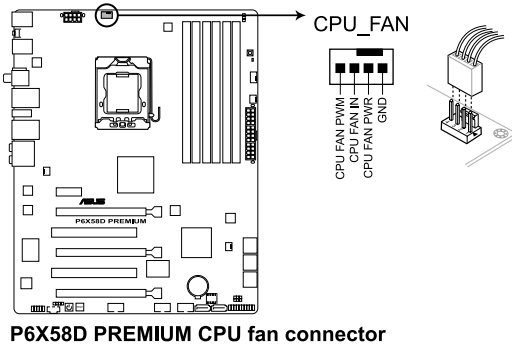

DO NOT forget to connect the CPU fan connector! Hardware monitoring errors can occur if you fail to plug this connector.

### 2.3.3 Uninstalling the CPU heatsink and fan

To uninstall the CPU fan cable from the connector on the motherboard:

1. Disconnect the CPU fan cable from the connector on the motherboard.
2. Rotate each fastener counterclockwise.
3. Pull up two fasteners at a time in a diagonal sequence to disengage the heatsink and fan assembly from the motherboard.

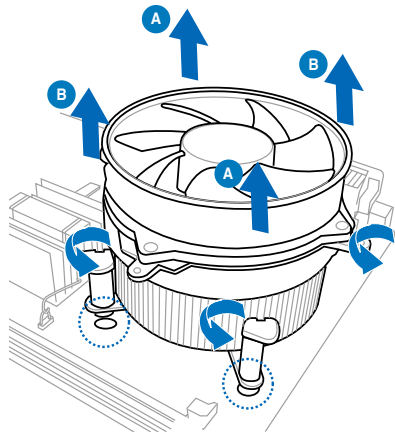
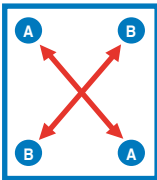

4. Carefully remove the heatsink and fan assembly from the motherboard.

## 2.4 System memory

### 2.4.1 Overview

The motherboard comes with six Double Data Rate 3 (DDR3) Dual Inline Memory Modules (DIMM) sockets.

A DDR3 module has the same physical dimensions as a DDR2 DIMM but is notched differently to prevent installation on a DDR2 DIMM socket. DDR3 modules are developed for better performance with less power consumption.

The figure illustrates the location of the DDR3 DIMM sockets:

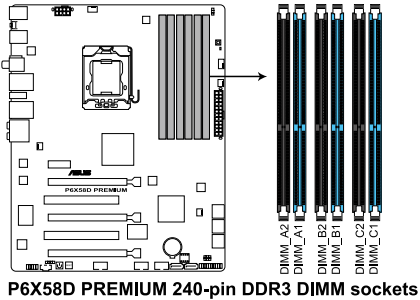

### Recommended memory configurations

#### One DIMM:

You may install one memory module in slot A1, B1 or C1 as a single-channel operation.

#### Two DIMMs (dual-channel operation):

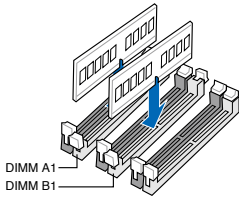

#### Three DIMMs (triple-channel operation):

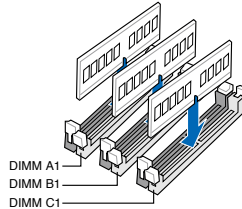

#### Four DIMMs (triple-channel operation):

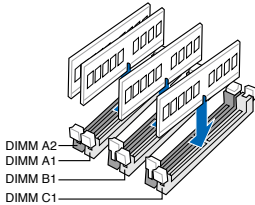

#### Six DIMMs (triple-channel operation):

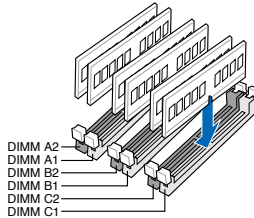

Due to Intel CPU spec definition, the system will not boot if only one DIMM is installed in DIMM slot A2, B2, or C2. Follow the illustrations above for recommended memory configuration.

## 2.4.2 Memory configurations

You may install 1GB, 2GB and 4GB unbuffered non-ECC DDR3 DIMMs into the DIMM sockets.



- You may install varying memory sizes in Channel A, Channel B and Channel C. The system maps the total size of the lower-sized channel for the dual-channel or triple-channel configuration. Any excess memory from the higher-sized channel is then mapped for single-channel operation.
- Due to Intel spec definition, X.M.P. DIMMs and DDR3-1600 are supported for one DIMM per channel only.
- According to Intel® CPU spec, DIMM voltage below 1.65V is recommended to protect the CPU.
- Always install DIMMs with the same CAS latency. For optimum compatibility, we recommend that you obtain memory modules from the same vendor.
- Due to the memory address limitation on 32-bit Windows OS, when you install 4GB or more memory on the motherboard, the actual usable memory for the OS can be about 3GB or less. For effective use of memory, we recommend that you do any of the following:
  - Use a maximum of 3GB system memory if you are using a 32-bit Windows OS.
  - Install a 64-bit Windows OS when you want to install 4GB or more on the motherboard.For more details, refer to the Microsoft® support site at <http://support.microsoft.com/kb/929605/en-us>.
- This motherboard does not support DIMMs made up of 512Mb (64MB) chips or less (Memory chip capacity counts in Megabit, 8 Megabit/Mb = 1 Megabyte/MB).



- The default memory operation frequency is dependent on its Serial Presence Detect (SPD), which is the standard way of accessing information from a memory module. Under the default state, some memory modules for overclocking may operate at a lower frequency than the vendor-marked value. To operate at the vendor-marked or at a higher frequency, refer to section 3.5 **Ai Tweaker menu** for manual memory frequency adjustment.
- For system stability, use a more efficient memory cooling system to support a full memory load (6 DIMMs) or overclocking condition.

## P6X58D Premium Motherboard Qualified Vendors Lists (QVL) DDR3-2000 MHz capability

Vendor	Part No.	Size	SS/ DS	Chip Brand	Chip NO.	Timing Label(Bios)	Voltage	DIMM socket support (Optional)	
								A*	B*
Crucial	BL12864BE2009.8SFB3(EPP)	1GB	SS	N/A	Heat-Sink Package	9-9-9-28(1333-9-9-9-24)	2	V	V
G.SKILL	F3-16000CL9D-4GBRH(XMP)	4GB(2 x 2GB)	DS	N/A	Heat-Sink Package	9-9-9-24 (1333-9-9-9-24)	1.65	V	V
G.SKILL	F3-16000CL9D-4GBTD(XMP)	4GB(2 x 2GB)	DS	N/A	Heat-Sink Package	9-9-9-24 (1333-9-9-9-24)	1.65	V	V
G.SKILL	F3-16000CL7T-6GBPS(XMP)	6GB(3 x 2GB)	DS	N/A	Heat-Sink Package	7-8-7-20(1066-8-8-8-20)	1.65	V	V
G.SKILL	F3-16000CL9T-6GBPS(XMP)	6GB(3 x 2GB)	DS	N/A	Heat-Sink Package	9-9-9-24(1066-8-8-8-20)	1.65	V	V
GEIL	GU34GB2000C9DC(XMP)	4GB(2 x 2GB)	DS	N/A	Heat-Sink Package	9-9-9-28 (1333-7-7-7-24)	2	V	V
KINGSTON	KHX2000C8D3T1K3/3GX(XMP)	3GB(3 x 1GB)	SS	N/A	Heat-Sink Package	8(1333-9-9-9-24)	1.65	V	V
KINGSTON	KHX2000C8D3T1K3/6GX(XMP)	6GB(3 x 2GB)	DS	N/A	Heat-Sink Package	8(1333-9-9-9-21)	1.65	V	V
KINGSTON	KHX2000C9D3T1K3/6GX(XMP)	6GB(3 x 2GB)	DS	N/A	Heat-Sink Package	9 (1333-9-9-9-24)	1.65	V	V
OCZ	OCZ3FXT20002GK	2GB(2 x 1GB)	SS	N/A	Heat-Sink Package	8	1.9	V	V
OCZ	OCZ3P20002GK(EPP)	2GB(2 x 1GB)	SS	N/A	Heat-Sink Package	9	1.9	V	V
OCZ	OCZ3B2000LV6GK	6GB(3 x 2GB)	DS	N/A	Heat-Sink Package	7-8-7(1066-9-9-9-24)	1.65	V	V
Ginggle	9CAASS37AZZ01D1	2GB	DS	N/A	Heat-Sink Package	9-9-9-24	N/A	V	V
Patriot	PVS32G2000LLKN	2GB(2 x 1GB)	SS	N/A	Heat-Sink Package	9-9-9-24(1066-7-7-7-20)	2	V	V
Patriot	PVT36G2000LLK(XMP)	6GB(3 x 2GB)	DS	N/A	Heat-Sink Package	8-8-8-24(1067-9-9-9-24)	1.65	V	V

## P6X58D Premium Motherboard Qualified Vendors Lists (QVL) DDR3-1866 MHz capability

Vendor	Part No.	Size	SS/ DS	Chip Brand	Chip NO.	Timing Label(Bios)	Voltage	DIMM socket support (Optional)	
								A*	B*
CORSAIR	TRX3G1866C9DVer4.1(XMP)	3GB(3 x 1GB)	SS	N/A	Heat-Sink Package	9-9-9-24(1866-9-9-9-24)	1.65	V	V
CORSAIR	TRX3G61866C9DVer4.1(XMP)	6GB(3 x 2GB)	DS	N/A	Heat-Sink Package	9-9-9-24(1866-9-9-9-24)	1.65	V	V
G.SKILL	F3-15000CL9D-4GBRH (XMP)	4GB(2 x 2GB)	DS	N/A	Heat-Sink Package	9-9-9-24 (1333-9-9-9-24)	1.65	V	V
G.SKILL	F3-15000CL9D-4GBTD(XMP)	4GB(2 x 2GB)	DS	N/A	Heat-Sink Package	9-9-9-24 (1333-9-9-9-24)	1.65	V	V
KINGSTON	KHX1866C9D3T1K3/6GX(XMP)	6GB(3 x 2GB)	DS	N/A	Heat-Sink Package	9(1333-9-9-9-24)	1.65	V	V
OCZ	OCZ3RPR1866C9LV3GK	3GB(3 x 1GB)	SS	N/A	Heat-Sink Package	9-9-9(1066-7-7-7-20)	1.65	V	V
OCZ	OCZ3P1866LV4GK	4GB(2 x 2GB)	DS	N/A	Heat-Sink Package	9-9-9(1067-9-9-9-24)	1.65	V	V
OCZ	OCZ3P1866C9LV6GK	6GB(3 x 2GB)	DS	N/A	Heat-Sink Package	9-9-9(1066-7-7-7-20)	1.65	V	V
OCZ	OCZ3RPR1866C9LV6GK	6GB(3 x 2GB)	DS	N/A	Heat-Sink Package	9-9-9(1066-7-7-7-20)	1.65	V	V
Super Talent	W1866UX2GB(XMP)	2GB(2 x 1GB)	SS	N/A	Heat-Sink Package	8-8-8-24(1333-9-9-9-24)	N/A	V	V
Patriot	PVS32G1866LLK(XMP)	2GB(2 x 1GB)	SS	N/A	Heat-Sink Package	8-8-8-24(1866-8-8-8-24)	1.9	V	V
Team	BoxP/N:TXD34096M1866HC7DC-L (TXD32048M1866HC7-L)(XMP)	4GB(2 x 2GB)	DS	N/A	Heat-Sink Package	7-7-7-21(1333-9-9-9-24)	1.65	V	V

## P6X58D Premium Motherboard Qualified Vendors Lists (QVL) DDR3-1800 MHz capability

Vendor	Part No.	Size	SS/ DS	Chip Brand	Chip NO.	Timing Label(Bios)	Voltage	DIMM socket support (Optional)	
								A*	B*
CORSAIR	BoxP/N:TW3X4G1800C8DF (CM3X2G1800C8D)Ver4.1(XMP)	4GB(2 x 2GB)	DS	N/A	Heat-Sink Package	8-8-8-24	1.80	V	
KINGSTON	KHX1800C9D3T1K3/6GX(XMP)	6GB(3 x 2GB)	DS	N/A	Heat-Sink Package	(1333-9-9-9-24)	1.65-1.85	V	V
OCZ	OCZ3P18002GK	2GB(2 x 1GB)	SS	N/A	Heat-Sink Package	8	1.65-1.85	V	V
Transcend	TX1800KLU-2GK(XMP)	2GB(2 x 1GB)	SS	N/A	Heat-Sink Package	8	1.65-1.85	V	V
Patriot	PVS32G1800LLKN(EPP)	2GB(2 x 1GB)	SS	N/A	Heat-Sink Package	8-8-8-20(1066-7-7-7-20)	1.9	V	V



# P6X58D Premium Motherboard Qualified Vendors Lists (QVL)

## DDR3-1600 MHz capability

Vendor	Part No.	Size	SS/DS	Chip Brand	Chip NO.	Timing Label(Bios)	Voltage	DIMM socket support (Optional)			
								A*	B*	C*	D*
A-DATA	AD31600G001GMU	1GB	SS	N/A	Heat-Sink Package	9-9-9-24 (1333-8-8-8-24)	1.65-1.85	V	V	V	V
A-DATA	AX3U1600GB1G9-AG	2GB(2 x 1GB)	SS	N/A	Heat-Sink Package	9-9-9-24 (1333-8-8-8-24)	1.65-1.85	V	V	V	V
A-DATA	AX3U1600PB1G8-2P	2GB(2 x 1GB)	SS	N/A	Heat-Sink Package	8-8-8-24(1333-9-9-9-24)	1.65-1.85	V	V	V	V
A-DATA	AD31600E001GMU	3GB(3 x 1GB)	SS	N/A	Heat-Sink Package	8-8-8-24(1333-9-9-9-24)	1.65-1.85	V	V	V	V
A-DATA	AX3U1600GB1G9-3G	3GB(3 x 1GB)	SS	N/A	Heat-Sink Package	9-9-9-24 (1333-8-8-8-24)	1.65-1.85	V	V	V	V
A-DATA	AX3U1600PB1G8-3P	3GB(3 x 1GB)	SS	N/A	Heat-Sink Package	8-8-8-24(1333-9-9-9-24)	1.65-1.85	V	V	V	V
A-DATA	AX3U1600GB2G9-AG(XMP)	4GB(2 x 2GB)	DS	N/A	Heat-Sink Package	9-9-9-24 (1600-9-9-9-24)	1.65-1.85	V	V	V	V
A-DATA	AX3U1600XB2G7-EF(XMP)	4GB(2 x 2GB)	DS	N/A	Heat-Sink Package	7-7-7-20(1333-9-9-9-24)	1.75-1.85	V	V	V	V
A-DATA	AD31600F002GMU(XMP)	6GB(3 x 2GB)	DS	N/A	Heat-Sink Package	7-7-7-20(1333-9-9-9-24)	1.75-1.85	V	V	V	V
A-DATA	AX3U1600GB2G9-3G(XMP)	6GB(3 x 2GB)	DS	N/A	Heat-Sink Package	9-9-9-24 (1600-9-9-9-24)	1.65-1.85	V	V	V	V
A-DATA	AX3U1600GB2G9-3G(XMP)	6GB(3 x 2GB)	DS	N/A	Heat-Sink Package	9-9-9-24 (1600-9-9-9-24)	1.65-1.85	V	V	V	V
A-DATA	AX3U1600XB2G7-FF(XMP)	6GB(3 x 2GB)	DS	N/A	Heat-Sink Package	7-7-7-20(1333-9-9-9-24)	1.75-1.85	V	V	V	V
CORSAIR	TR3X3G1600C8D	3GB(3 x 1GB)	SS	N/A	Heat-Sink Package	8-8-8-24(1600-8-8-8-24)	1.65	V	V	V	V
CORSAIR	TR3X3G1600C8DVer2.1(XMP)	3GB(3 x 1GB)	SS	N/A	Heat-Sink Package	8-8-8-24(1601-8-8-8-24)	1.65	V	V	V	V
CORSAIR	TR3X3G1600C9Ver1.1(XMP)	3GB(3 x 1GB)	SS	N/A	Heat-Sink Package	9-9-9-24(1601-9-9-9-24)	1.65	V	V	V	V
CORSAIR	BoxP/N:TW3X4G1600C9DHXNV(CM3X2G1600C9DHXNV)Ver4.1	4GB(2 x 2GB)	DS	N/A	Heat-Sink Package	(1333-9-9-9-24)	1.80	V	V	V	V
CORSAIR	CMD4GX3M2A1600C8(XMP)	4GB(2 x 2GB)	DS	N/A	Heat-Sink Package	8-8-8-24(1333-9-9-9-24)	1.65	V	V	V	V
CORSAIR	TR3X6G1600C8D	6GB(3 x 2GB)	DS	N/A	Heat-Sink Package	8-8-8-24(1600-8-8-8-24)	1.65	V	V	V	V
CORSAIR	TR3X6G1600C8DVer2.1(XMP)	6GB(3 x 2GB)	DS	N/A	Heat-Sink Package	8-8-8-24(1601-8-8-8-24)	1.65	V	V	V	V
CORSAIR	TR3X6G1600C9Ver2.1(XMP)	6GB(3 x 2GB)	DS	N/A	Heat-Sink Package	9-9-9-24(1333-9-9-9-24)	1.65	V	V	V	V
Crucial	BL12864BA1608.8SFB(XMP)	1GB	SS	N/A	Heat-Sink Package	(1601-8-8-8-24)	1.8	V	V	V	V
Crucial	BL25664BN1608.16FF(XMP)	2GB	DS	N/A	Heat-Sink Package	8-8-8-24 (1333-9-9-9-24)	1.65	V	V	V	V
G.SKILL	F3-12800CL9D-2GBNQ	2GB(2 x 1GB)	SS	N/A	Heat-Sink Package	(1333-9-9-9-24)	1.6	V	V	V	V
G.SKILL	F3-12800CL9D-4GBRL	2GB(2 x 1GB)	SS	N/A	Heat-Sink Package	(1333-9-9-9-24)	1.6	V	V	V	V
G.SKILL	F3-12800CL7D-4GBRH(XMP)	4GB(2 x 2GB)	DS	N/A	Heat-Sink Package	7-7-7-24(1333-8-8-8-24)	1.65	V	V	V	V
G.SKILL	F3-12800CL8T-6GBHK(XMP)	6GB(3 x 2GB)	DS	N/A	Heat-Sink Package	8-8-8-21(1333-8-8-8-21)	1.6-1.65	V	V	V	V
G.SKILL	F3-12800CL8T-6GBP(XMP)	6GB(3 x 2GB)	DS	N/A	Heat-Sink Package	8-8-8-21(1066-8-8-8-20)	1.6-1.65	V	V	V	V
G.SKILL	F3-12800CL9T-6GBNQ	6GB(3 x 2GB)	DS	N/A	Heat-Sink Package	9-9-9-24(1601-9-9-9-24)	1.5-1.6	V	V	V	V
GEIL	GV34GB1600C8DC	4GB(2 x 2GB)	DS	N/A	Heat-Sink Package	8-8-8-28(1600-8-8-8-28)	1.6	V	V	V	V
KINGMAX	FLGD45F-B8K9-NAES	1GB	SS	KINGMAX	KFB8FNGXF-ANX-12A	9(1600-9-8-9-28)	1.5	V	V	V	V
KINGMAX	FLGE85F-B8K9-NEES	2GB	DS	KINGMAX	KFB8FNGXF-ANX-12A	9(1600-9-8-9-28)	1.5	V	V	V	V
KINGSTON	KHX1600C9D3K3/12GX(XMP)	12GB(3 x 4GB)	DS	N/A	Heat-Sink Package	(1066-7-7-7-20)	1.65	V	V	V	V
KINGSTON	KHX1600C8D3K2/4GX(XMP)	4GB(2 x 2GB)	DS	N/A	Heat-Sink Package	8(1333-9-9-9-24)	1.65	V	V	V	V
KINGSTON	KHX1600C9D3K3/6GX(XMP)	6GB(3 x 2GB)	DS	N/A	Heat-Sink Package	9(1333-9-9-9-24)	1.65	V	V	V	V
OCZ	OCZ3P1600EB1G	1GB	SS	N/A	Heat-Sink Package	7-6-6-24(1333-7-7-7-20)	N/A	V	V	V	V
OCZ	OCZ3G1600LV3GK	3GB(3 x 1GB)	SS	N/A	Heat-Sink Package	8-8-8(1066-7-7-7-20)	1.65	V	V	V	V
OCZ	OCZ3P1600LV3GK	3GB(3 x 1GB)	SS	N/A	Heat-Sink Package	7-7-7(1066-7-7-7-20)	1.65	V	V	V	V
OCZ	OCZ3P1600EB4GK	4GB(2 x 2GB)	DS	N/A	Heat-Sink Package	7-7-6(1333-7-7-7-20)	1.8	V	V	V	V
OCZ	OCZ3P1600LV4GK	4GB(2 x 2GB)	DS	N/A	Heat-Sink Package	7-7-7(1067-7-7-7-20)	1.65	V	V	V	V
OCZ	OCZ3X16004GK(XMP)	4GB(2 x 2GB)	DS	N/A	Heat-Sink Package	7-7-7(1066-7-7-7-16)	1.9	V	V	V	V
OCZ	OCZ3FXE1600C7LV6GK	6GB(3 x 2GB)	DS	N/A	Heat-Sink Package	7-7-7(1066-9-9-9-24)	1.65	V	V	V	V
OCZ	OCZ3G1600LV6GK	6GB(3 x 2GB)	DS	N/A	Heat-Sink Package	8-8-8(1066-7-7-7-20)	1.65	V	V	V	V
OCZ	OCZ3G1600LV6GK	6GB(3 x 2GB)	DS	N/A	Heat-Sink Package	8-8-8(1066-7-7-7-16)	1.65	V	V	V	V
OCZ	OCZ3X1600LV6GK(XMP)	6GB(3 x 2GB)	DS	N/A	Heat-Sink Package	8-8-8(1600-8-8-8-24)	1.65	V	V	V	V
OCZ	OCZ3X1600LV6GK(XMP)	6GB(3 x 2GB)	DS	N/A	Heat-Sink Package	8-8-8(1066-7-7-7-16)	1.65	V	V	V	V
Super Talent	WB160UX6GB(XMP)	6GB(3 x 2GB)	DS	N/A	Heat-Sink Package	(1333-8-8-8-24)	N/A	V	V	V	V
Cell Shock	CS322271	2GB(2 x 1GB)	DS	N/A	Heat-Sink Package	7-7-7-14(1066-7-7-7-20)	1.7-1.9	V	V	V	V
Elixir	M2F2G64CB8HA4N-DG	2GB	DS	Elixir	N2CB1G80AN-DG	9(1333-9-9-9-28)	N/A	V	V	V	V
Elixir	M2Y2G64CB8HA9N-DG(XMP)	2GB	DS	N/A	Heat-Sink Package	(1333-8-8-8-24)	N/A	V	V	V	V
Mushkin	996657	4GB(2 x 2GB)	DS	N/A	Heat-Sink Package	7-7-7-20	N/A	V	V	V	V
Mushkin	998659(XMP)	6GB(3 x 2GB)	DS	N/A	Heat-Sink Package	9-9-9-24(1333-9-9-9-24)	1.5-1.6	V	V	V	V
Patriot	PVT33G1600ELK	3GB(3 x 1GB)	SS	N/A	Heat-Sink Package	9-9-9-24(1066-7-7-7-20)	1.65	V	V	V	V
PATRIOT	PGS34G1600LLKA	4GB(2 x 2GB)	DS	N/A	Heat-Sink Package	7-7-7-20(1067-7-7-7-20)	1.7	V	V	V	V
Patriot	PVS34G1600ELK	4GB(2 x 2GB)	DS	N/A	Heat-Sink Package	9-9-9-24(1066-7-7-7-20)	1.8	V	V	V	V
Patriot	PVS34G1600LLKN	4GB(2 x 2GB)	DS	N/A	Heat-Sink Package	7-7-7-20(1066-7-7-7-20)	2.0	V	V	V	V
Patriot	PVT36G1600ELK	6GB(3 x 2GB)	DS	N/A	Heat-Sink Package	9-9-9-24(1066-7-7-7-20)	1.65	V	V	V	V
Patriot	PVT36G1600ELK	6GB(3 x 2GB)	DS	N/A	Heat-Sink Package	9-9-9-24(1600-7-7-7-20)	1.65	V	V	V	V
Patriot	PVT36G1600LLK(XMP)	6GB(3 x 2GB)	DS	N/A	Heat-Sink Package	8-8-8-24(1067-7-7-7-20)	1.65	V	V	V	V

# P6X58D Premium Motherboard Qualified Vendors Lists (QVL)

## DDR3-1333 MHz capability

Vendor	Part No.	Size	SS/DS	Chip Brand	Chip NO.	Timing (Bios)	Voltage	DIMM socket support (Optional)			
								A*	B*	C*	D*
A-DATA	AD3133301GOU	1GB	SS	A-DATA	AD30908C8D-15IG	(1333-9-9-9-24)	N/A	V	V	V	V
A-DATA	AD3133302GOU	2GB	DS	A-DATA	AD30908C8D-15IG	(1333-9-9-9-24)	N/A	V	V	V	V
A-DATA	AD3U1333B2G9-2	2GB	DS	A-DATA	AD30908C8D-15IG	(1333-9-9-9-24)	N/A	V	V	V	V
A-DATA	AX3U1333P2G7-2P	4GB(2 x 2GB)	DS	N/A	Heat-Sink Package	7-7-7-20(1333-9-9-9-24)	1.65-1.85	V	V	V	V
A-DATA	AD3U1333C4G9-B	4GB	DS	Hynix	H5TQ2G83AFRH9C	1333-9-9-9-24	N/A	V	V	V	V
A-DATA	AD31333E002G0U	6GB(3 x 2GB)	DS	N/A	Heat-Sink Package	7-7-7-20(1333-9-9-9-24)	1.65-1.85	V	V	V	V
A-DATA	AX3U1333P2G7-3P	6GB(3 x 2GB)	DS	N/A	Heat-Sink Package	7-7-7-20(1333-9-9-9-24)	1.65-1.85	V	V	V	V
CORSAIR	TR3X3G1333C9 (Ver2.1)	3GB(3 x 1GB)	SS	N/A	Heat-Sink Package	9-9-9-24(1333-9-9-9-24)	1.5	V	V	V	V
CORSAIR	CM3X1024-1333C9DHX	1GB	DS	N/A	Heat-Sink Package	(1333-9-9-9-24)	1.1	V	V	V	V
CORSAIR	BoxPIN-TWINGX2048-1333C9 (CM3X1024-1333C9)Ver1.1	2GB(2 x 1GB)	DS	N/A	Heat-Sink Package	9-9-9-24(1066-7-7-7-20)	1.70	V	V	V	V
CORSAIR	BoxPIN-TW3X4G1333C9DHX (CM3X2048-1333C9DHX)Ver3.2	4GB(2 x 2GB)	DS	N/A	Heat-Sink Package	9-9-9-24(1066-7-7-7-20)	1.70	V	V	V	V
CORSAIR	TR3X6G1333C9 (Ver2.1)	6GB(3 x 2GB)	DS	N/A	Heat-Sink Package	9-9-9-24(1333-9-9-9-24)	1.5	V	V	V	V
Crucial	CT12864BA1339.8FF	1GB	SS	MICRON	D9KPT	9(1333-9-9-9-24)	N/A	V	V	V	V
Crucial	CT12864BA1339.8SFD	1GB	SS	MICRON	MT8JTF12864AY-1G4D1	9(1333-9-9-9-24)	N/A	V	V	V	V
Crucial	CT12872BA1339.9FF	1GB	SS	MICRON	D9KPT(ECC)	9(1333-9-9-9-24)	N/A	V	V	V	V
Crucial	BL25664BN1337.16FF(XMP)	2GB	DS	N/A	Heat-Sink Package	7-7-7-24(1333-9-9-9-24)	1.65	V	V	V	V
Crucial	CT25664BA1339.16FF	2GB	DS	MICRON	D9KPT	9(1333-9-9-9-24)	N/A	V	V	V	V
Crucial	CT25664BA1339.16SFD	2GB	DS	MICRON	D9JNM	(1333-9-9-9-24)	N/A	V	V	V	V
Crucial	CT25672BA1339.18FF	2GB	DS	MICRON	D9KPT(ECC)	9(1333-9-9-9-24)	N/A	V	V	V	V
Crucial	BL25664BA1336.16SFB1	4GB(2 x 2GB)	DS	N/A	Heat-Sink Package	6-6-6-20(1333-9-9-9-24)	1.8	V	V	V	V
ELPIDA	EBJ10UE8BAWO-DJ-E	1GB	SS	ELPIDA	J1108BAGB-DJ-E	9(1333-9-9-9-24)	N/A	V	V	V	V
ELPIDA	EBJ21UE8BAWO-DJ-E	2GB	DS	ELPIDA	J1108BAGB-DJ-E	9(1333-9-9-9-24)	N/A	V	V	V	V
G.SKILL	F3-10600CL7D-2GBPI	2GB(2 x 1GB)	SS	N/A	Heat-Sink Package	(1337-7-7-7-18)	1.65	V	V	V	V
G.SKILL	F3-10600CL8D-2GBHK	2GB(2 x 1GB)	SS	N/A	Heat-Sink Package	(1337-8-8-8-22)	1.65	V	V	V	V
G.SKILL	F3-10666CL7T-6GBPK(XMP)	2GB	DS	N/A	Heat-Sink Package	7-7-7-18(1333-7-7-7-18)	1.5-1.6	V	V	V	V
G.SKILL	F3-10666CL7D-4GBPI(XMP)	4GB(2 x 2GB)	DS	N/A	Heat-Sink Package	7-7-7-21(1333-9-9-9-24)	1.5	V	V	V	V
G.SKILL	F3-10666CL7D-4GBRH(XMP)	4GB(2 x 2GB)	DS	N/A	Heat-Sink Package	7-7-7-21(1333-9-9-9-24)	1.5	V	V	V	V
G.SKILL	F3-10666CL8D-4GBHK(XMP)	4GB(2 x 2GB)	DS	N/A	Heat-Sink Package	8-8-8-21(1333-7-7-7-20)	1.5-1.6	V	V	V	V
G.SKILL	F3-10666CL8D-4GBRM(XMP)	4GB(2 x 2GB)	DS	N/A	Heat-Sink Package	8-8-8-21(1333-7-7-7-20)	1.5-1.6	V	V	V	V
G.SKILL	F3-10666CL9D-4GBNQ	4GB(2 x 2GB)	DS	N/A	Heat-Sink Package	(1333-9-9-9-24)	1.65	V	V	V	V
G.SKILL	F3-10666CL9D-4GBRL	4GB(2 x 2GB)	DS	N/A	Heat-Sink Package	(1333-9-9-9-24)	1.65	V	V	V	V
G.SKILL	F3-10666CL9T-6GBNQ	6GB(3 x 2GB)	DS	N/A	Heat-Sink Package	9-9-9-24(1333-9-9-9-24)	1.5	V	V	V	V
GEIL	GG34GB1333C9NDC	4GB(2 x 2GB)	DS	GEIL	GL1L128M88BA12N	9-9-9-24(1333-9-9-9-24)	1.3	V	V	V	V
GEIL	GV34GB1333C7DC	4GB(2 x 2GB)	DS	N/A	Heat-Sink Package	7-7-7-24(1333-8-8-8-28)	1.5	V	V	V	V
Hynix	HMT112U6BFR8C-H9	1GB	SS	Hynix	H5TQ1G83BFR	9(1333-9-9-9-24)	N/A	V	V	V	V
Hynix	HMT125U6BFR8C-H9	2GB	DS	Hynix	H5TQ1G83BFR	9(1333-9-9-9-24)	N/A	V	V	V	V
Hynix	HMT125U6BFR8C-H9	2GB	DS	Hynix	H5TQ1G83BFRH9C	9(1333-9-9-9-24)	N/A	V	V	V	V
KINGMAX	FLFD45F-8BE89	1GB	SS	ELPIDA	J1108BASE-DJ-E	(1333-9-9-9-24)	N/A	V	V	V	V
KINGSTON	KVR1333D3N9/1G	1GB	SS	Hynix	H5TQ1G83BFR	9(1333-9-9-9-24)	1.5	V	V	V	V
KINGSTON	KVR1333D3N9/1G	1GB	SS	ELPIDA	J1108BAGB-DJ-E	9(1066-8-7-7-20)	1.5	V	V	V	V
KINGSTON	KVR1333D3N9/2G	2GB	DS	Qimonda	IDSH1G-03A1F1C-13H	9(1333-9-9-9-24)	1.5	V	V	V	V
KINGSTON	KVR1333D3N9/4G	4GB	DS	SAMSUNG	K4B2G0846B-HCH9	9(1333-9-9-9-24)	1.5	V	V	V	V
MICRON	MT8JTF12864AZ-1G4F1	1GB	SS	MICRON	9FF22 D9KPT	9(1066-8-8-8-20)	N/A	V	V	V	V
MICRON	MT8JTF12864AZ-1G4F1	1GB	SS	MICRON	D9KPT	9(1333-9-9-9-24)	N/A	V	V	V	V
MICRON	MT9J5F12872AZ-1G4F1	1GB	SS	MICRON	D9KPT(ECC)	9(1333-9-9-9-24)	N/A	V	V	V	V
MICRON	MT16JF25664AZ-1G4F1	2GB	DS	MICRON	D9KPT	9(1333-9-9-9-24)	N/A	V	V	V	V
MICRON	MT16JTF25664AZ-1G4F1	2GB	DS	MICRON	9FF22 D9KPT	9(1066-8-8-8-20)	N/A	V	V	V	V
MICRON	MT18J5F25672AZ-1G4F1	2GB	DS	MICRON	D9KPT(ECC)	9(1333-9-9-9-24)	N/A	V	V	V	V
OCZ	OC23PXP1333EB2GK	1GB	SS	N/A	Heat-Sink Package	(1066-6-5-5-20)	N/A	V	V	V	V
OCZ	OC23G1333LV3GK	3GB(3 x 1GB)	SS	N/A	Heat-Sink Package	9-9-9(1066-7-7-7-20)	1.65	V	V	V	V
OCZ	OC23P1333LV3GK	3GB(3 x 1GB)	SS	N/A	Heat-Sink Package	7-7-7(1066-7-7-7-16)	1.65	V	V	V	V
OCZ	OC23P13332GK	1GB	DS	N/A	Heat-Sink Package	7-7-7-20(1333-9-9-9-24)	N/A	V	V	V	V
OCZ	OC23P13334GK	4GB(2 x 2GB)	DS	N/A	Heat-Sink Package	7(1333-7-7-7-20)	1.8	V	V	V	V
OCZ	OC23P1333LV4GK	4GB(2 x 2GB)	DS	N/A	Heat-Sink Package	7-7-7(1067-9-9-9-24)	1.65	V	V	V	V

## P6X58D Premium Motherboard Qualified Vendors Lists (QVL) DDR3-1333 MHz capability (cont.)

Vendor	Part No.	Size	SS/ DS	Chip Brand	Chip NO.	Timing Label(Bios)	Voltage	DIMM socket support (Optional)					
								A*	B*	C*	D*		
OCZ	OCZ3RPX1333EB4GK	4GB(2 x 2GB)	DS	N/A	Heat-Sink Package	(1066-6-5-5)	1.85	V	V				
OCZ	OCZ3G1333LV6GK	6GB(3 x 2GB)	DS	N/A	Heat-Sink Package	9-9-9(1066-7-7-7-20)	1.65	V	V	V			
OCZ	OCZ3P1333LV6GK	6GB(3 x 2GB)	DS	N/A	Heat-Sink Package	7-7-7(1066-7-7-7-20)	1.65	V	V	V			
OCZ	OCZX1333LV6GK(XMP)	6GB(3 x 2GB)	DS	NA	Heat-Sink Package	8-8-8(1066-7-7-7-16)	1.6	V	V	V	V		
SAMSUNG	M378B2873DZ1-CH9	1GB	SS	SAMSUNG	K4B1G0846D	9(1333-9-9-9-24)	N/A	V	V	V	V		
SAMSUNG	M378B2873EH1-CH9	1GB	SS	SAMSUNG	K4B1G0846E	(1066-8-7-7-20)	N/A	V	V	V	V		
SAMSUNG	M391B2873DZ1-CH9	1GB	SS	SAMSUNG	K4B1G0846D(ECC)	9(1333-9-9-9-24)	N/A	V	V	V	V		
SAMSUNG	M378B5673DZ1-CH9	2GB	DS	SAMSUNG	K4B1G0846D	9(1333-9-9-9-24)	N/A	V	V	V	V		
SAMSUNG	M378B5673EH1-CH9	2GB	DS	SAMSUNG	K4B1G0846E	(1066-8-7-7-20)	N/A	V	V	V	V		
SAMSUNG	M391B5673DZ1-CH9	2GB	DS	SAMSUNG	K4B1G0846D(ECC)	9(1333-9-9-9-24)	N/A	V	V	V	V		
SAMSUNG	M378B5273BH1-CH9	4GB	DS	SAMSUNG	K4B2G0846B-HCH9	9(1333-9-9-9-24)	N/A	V	V	V	V		
Super Talent	W1333UX2GB(XMP)	2GB(2 x 1GB)	SS	N/A	Heat-Sink Package	8(1333-8-8-8-24)	1.8	V	V	V	V		
Transcend	TS128MLK64V3U	1GB	SS	SAMSUNG	K4B1G0846D	9(1333-9-9-9-24)	N/A	V	V	V	V		
Transcend	TS256MLK64V3U	2GB	DS	SAMSUNG	K4B1G0846D	9(1333-9-9-9-24)	N/A	V	V	V	V		
Asint	SLY3128M8-EDJ	1GB	SS	Asint	DDRIII1208-DJ	(9-9-9-24)	N/A	V	V	V	V		
Asint	SLY3128M8-EDJE	1GB	SS	ELPIDA	J1108BASE-DJ-E	(1066-8-8-8-20)	N/A	V	V	V	V		
Asint	SLZ3128M8-EDJ	2GB	DS	Asint	DDRIII1208-DJ	(9-9-9-24)	N/A	V	V	V	V		
Asint	SLZ3128M8-EDJE	2GB	DS	ELPIDA	J1108BASE-DJ-E	(1066-8-8-8-20)	N/A	V	V	V	V		
ASUS	N/A	1GB	DS	N/A	Heat-Sink Package	(1333-9-9-9-24)	N/A	V	V	V	V		
ATP	AQ28M64A8BJH9S	1GB	SS	SAMSUNG	K4B1G0846E	(1333-9-9-9-24)	N/A	V	V	V	V		
ATP	AQ28M72D8BJH9S	1GB	SS	SAMSUNG	K4B1G0846D(ECC)	(1333-9-9-9-24)	N/A	V	V	V	V		
ATP	AQ56M64B8BJH9S	2GB	DS	SAMSUNG	K4B1G0846D	(1333-9-9-9-24)	N/A	V	V	V	V		
ATP	AQ56M72E8BJH9S	2GB	DS	SAMSUNG	K4B1G0846D(ECC)	(1333-9-9-9-24)	N/A	V	V	V	V		
BUFFALO	FSX1333D3G-1G	1GB	SS	N/A	Heat-Sink Package	(1066-7-7-7-20)	N/A	V	V	V	V		
BUFFALO	FSH1333D3G-T3G(XMP)	3GB(3 x 1GB)	SS	N/A	Heat-Sink Package	7-7-7-20(1066-8-7-7-20)	N/A	V	V	V	V		
BUFFALO	FSX1333D3G-2G	2GB	DS	N/A	Heat-Sink Package	(1066-7-7-7-20)	N/A	V	V	V	V		
Elixir	M2Y2G64CB8HA9N-CG	2GB	DS	N/A	Heat-Sink Package	(1333-7-7-7-20)	N/A	V	V	V	V		
Patriot	PDC32G1333LLK	1GB	SS	PATRIOT	Heat-Sink Package	7(1337-7-7-7-20)	1.7	V	V	V	V		
Patriot	PVT33G1333ELK	3GB(3 x 1GB)	SS	N/A	Heat-Sink Package	9-9-9-24(1066-7-7-7-20)	1.65	V	V	V	V		
Patriot	PVS34G1333ELK	4GB(2 x 2GB)	DS	N/A	Heat-Sink Package	9-9-9-24(1066-7-7-7-20)	1.5	V	V	V	V		
Patriot	PVS34G1333LLK	4GB(2 x 2GB)	DS	N/A	Heat-Sink Package	7-7-7-20(1066-7-7-7-20)	1.7	V	V	V	V		
Patriot	PVT36G1333ELK	6GB(3 x 2GB)	DS	N/A	Heat-Sink Package	9-9-9-24(1066-7-7-7-20)	1.65	V	V	V	V		
Silicon Power	SP001GBLTU133S02	1GB	SS	S-POWER	I0YT3E0	9(1333-9-9-9-24)	N/A	V	V	V	V		
Silicon Power	SP002GBLTU133S02	2GB	DS	S-POWER	I0YT3E0	9(1333-9-9-9-24)	N/A	V	V	V	V		

## P6X58D Premium Motherboard Qualified Vendors Lists (QVL) DDR3-1066 MHz capability

Vendor	Part No.	Size	SS/ DS	Chip Brand	Chip NO.	Timing Label(Bios)	Voltage	DIMM socket support (Optional)			
								A*	B*	C*	D*
CORSAIR	CM3X1024-1066C7	1GB	DS	N/A	Heat-Sink Package	7	1.1	V	V	V	
Crucial	CT12864BA1067.8FF	1GB	SS	MICRON	D9KPT	7(1066-7-7-7-20)	N/A	V	V	V	V
Crucial	CT12864BA1067.8SFD	1GB	SS	MICRON	D9JNL	7	N/A	V	V	V	V
Crucial	CT12872BA1067.9FF	1GB	SS	MICRON	D9KPT(ECC)	7(1066-9-9-9-25)	N/A	V	V	V	V
Crucial	CT25664BA1067.16FF	2GB	DS	MICRON	D9KPT	7(1066-7-7-7-20)	N/A	V	V	V	
Crucial	CT25664BA1067.16SFD	2GB	DS	MICRON	D9JNL	7	N/A	V	V	V	V
Crucial	CT25672BA1067.18FF	2GB	DS	MICRON	D9KPT(ECC)	7(1066-7-7-7-20)	N/A	V	V		
ELPIDA	EBJ10UE8BAW0-AE-E	1GB	SS	ELPIDA	J1108BABG-DJ-E	7(1066-7-7-7-20)	N/A	V	V	V	V
ELPIDA	EBJ11RD8BAFA-AE-E	1GB	DS	ELPIDA	J5308BASE-AC-E(ECC)	7	N/A	V	V	V	V
ELPIDA	EBJ11UD8BAFA-AG-E	1GB	DS	ELPIDA	J5308BASE-AC-E	8	N/A	V	V	V	
ELPIDA	EBJ21UE8BAW0-AE-E	2GB	DS	ELPIDA	J1108BABG-DJ-E	7(1066-7-7-7-20)	N/A	V	V	V	V
Hynix	HMT112U6AFP8C-G7N0	1GB	SS	HYNIX	H5TQ1G83AFP7C	7	N/A	V	V	V	V
Hynix	HYMT112U6AZNF8-G7	1GB	SS	HYNIX	HY5TQ1G831ZNF7-G7	7	N/A	V	V		
Hynix	HMT125U6AFP8C-G7N0	2GB	DS	HYNIX	H5TQ1G83AFP7C	7	N/A	V	V	V	V
Hynix	HYMT125U6AZNF8-G7	2GB	DS	HYNIX	HY5TQ1G831ZNF7-G7	7	N/A	V	V	V	V
KINGSTON	KVR1066D3N7/1G	1GB	SS	KINGSTON	D1288JEKAPA7U	7(1067-7-7-7-20)	1.5	V	V	V	V
KINGSTON	KVR1066D3N7/1G	1GB	SS	ELPIDA	J1108BABG-DJ-E	(1066-7-7-7-20)	1.5	V	V	V	V
KINGSTON	KVR1066D3N7/2G	2GB	DS	KINGSTON	D1288JEKAPA7U	7(1067-7-7-7-20)	1.5	V	V	V	V
KINGSTON	KVR1066D3N7/2G	2GB	DS	ELPIDA	J1108BABG-DJ-E	(1066-7-7-7-20)	1.5	V	V	V	V
KINGSTON	KVR1066D3N7/4G	4GB	DS	SAMSUNG	K4B2G0846B-HCF8	(1066-7-7-7-20)	1.5	V	V	V	V
MICRON	MT8JTF12864AY-1G1D1	1GB	SS	MICRON	7VD22	7	N/A	V	V	V	V
MICRON	MT8JTF12864AZ-1G1F1	1GB	SS	MICRON	8ZF22 D9KPV	7(1066-7-7-7-20)	N/A	V	V	V	V
MICRON	MT8JTF12864AZ-1G1F1	1GB	SS	MICRON	D9KPT	7(1066-7-7-7-20)	N/A	V	V	V	V
MICRON	MT9JSF12872AZ-1G1F1	1GB	SS	MICRON	D9KPT(ECC)	7(1066-9-9-9-25)	N/A	V	V	V	V
MICRON	MT16JTF25664AY-1G1D1	2GB	DS	MICRON	7VD22	7	N/A	V	V	V	V
MICRON	MT16JTF25664AZ-1G1F1	2GB	DS	MICRON	8ZF22 D9KPV	7(1066-7-7-7-20)	N/A	V	V	V	V
MICRON	MT16JTF25664AZ-1G1F1	2GB	DS	MICRON	D9KPT	7(1066-7-7-7-20)	N/A	V	V	V	
MICRON	MT18JSF25672AZ-1G1F1	2GB	DS	MICRON	D9KPT(ECC)	7(1066-7-7-7-20)	N/A	V	V		
SAMSUNG	K3M7885273BH1-CF8	4GB	DS	SAMSUNG	K4B2G0846B-HCF8	8(7-7-7-20)	1.5	V	V	V	V
Transcend	TS256MLK64V1U	2GB	DS	ELPIDA	J1108BABG-AE-E	7(1066-7-7-7-20)	N/A	V	V	V	V
Asint	SLY3128M8-EAE	1GB	SS	Asint	DDRIII1208-AE	(7-7-7-20)	N/A	V	V	V	V
Asint	SLZ3128M8-EAE	2GB	DS	Asint	DDRIII1208-AE	(7-7-7-20)	N/A	V	V	V	V
Elixir	M2Y2G64CB8HA9N-BE	2GB	DS	N/A	Heat-Sink Package	(1066-7-7-7-20)	N/A	V	V	V	V
WITEC	3DU3191A-10	1GB	DS	Qimonda	IDSH51-03A1F1C-10F	7	N/A	V	V		



### Side(s): SS - Single-sided DS - Double-sided DIMM support:

- **A\*:** Supports two (2) modules inserted into slot A1 and B1 as one pair of Dual-channel memory configuration.
- **B\*:** Supports three (3) modules inserted into the blue slots (A1, B1 and C1) as one set of Triple-channel memory configuration.
- **C\*:** Supports four (4) modules inserted into the blue slots (A1, B1 and C1) and the black slot A2 as one set of Triple-channel memory configuration.
- **D\*:** Supports six (6) modules inserted into both the blue slots and the black slots as two set of Triple-channel memory configuration.



- ASUS exclusively provides hyper DIMM support function.
- Hyper DIMM support is subject to the physical characteristics of individual CPUs. Load the X.M.P. or D.O.C.P. settings in the BioS for the hyper DIMM support.
- Visit the ASUS website for the latest QVL.

### 2.4.3 Installing a DIMM



Ensure to unplug the power supply before adding or removing DIMMs or other system components. Failure to do so may cause severe damage to both the motherboard and the components.

To install a DIMM:

1. Press the retaining clips outward to unlock a DIMM socket.
2. Align a DIMM on the socket such that the notch on the DIMM matches the break on the socket.

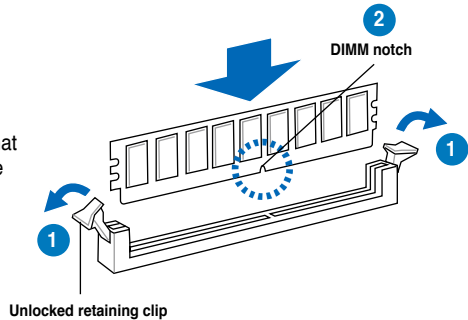

A DIMM is keyed with a notch so that it fits in only one direction. **DO NOT** force a DIMM into a socket to avoid damaging the DIMM.

3. Firmly insert the DIMM into the socket until the retaining clips snap back in place and the DIMM is properly seated.

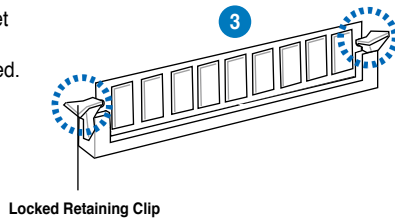

### 2.4.4 Removing a DIMM

To remove a DIMM:

1. Simultaneously press the retaining clips outward to unlock the DIMM.

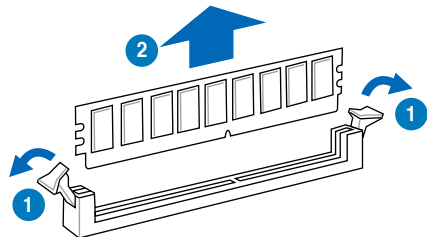

Support the DIMM lightly with your fingers when pressing the retaining clips. The DIMM might get damaged when it flips out with extra force.

2. Remove the DIMM from the socket.

## 2.5 Expansion slots

In the future, you may need to install expansion cards. The following subsections describe the slots and the expansion cards that they support.



---

Ensure to unplug the power cord before adding or removing expansion cards. Failure to do so may cause you physical injury and damage motherboard components.

---

### 2.5.1 Installing an expansion card

To install an expansion card:

1. Before installing the expansion card, read the documentation that came with it and make the necessary hardware settings for the card.
2. Remove the system unit cover (if your motherboard is already installed in a chassis).
3. Remove the bracket opposite the slot that you intend to use. Keep the screw for later use.
4. Align the card connector with the slot and press firmly until the card is completely seated on the slot.
5. Secure the card to the chassis with the screw you removed earlier.
6. Replace the system cover.

### 2.5.2 Configuring an expansion card

After installing the expansion card, configure it by adjusting the software settings.

1. Turn on the system and change the necessary BIOS settings, if any. See Chapter 3 for information on BIOS setup.
2. Assign an IRQ to the card. Refer to the tables on the next page.
3. Install the software drivers for the expansion card.



---

When using PCI cards on shared slots, ensure that the drivers support “Share IRQ” or that the cards do not need IRQ assignments. Otherwise, conflicts will arise between the two PCI groups, making the system unstable and the card inoperable. Refer to the table on the next page for details.

---

## 2.5.3 Interrupt assignments

### Standard interrupt assignments

IRQ	Priority	Standard function
0	1	System Timer
1	2	Keyboard Controller
2	–	Redirect to IRQ#9
4	12	Communications Port (COM1)*
5	13	IRQ Holder for PCI Steering*
6	14	Floppy Disk Controller
7	15	Reserved
8	3	System CMOS/Real Time Clock
9	4	IRQ Holder for PCI Steering*
10	5	IRQ Holder for PCI Steering*
11	6	IRQ Holder for PCI Steering*
12	7	Reserved
13	8	Numeric Data Processor
14	9	Primary IDE Channel

\* These IRQs are usually available for PCI devices.

### IRQ assignments for this motherboard

#### IOH

	24	25	26	27	28	29	30	31
NEC USB 3.0	–	–	–	–	–	used	–	–
Marvell 9123	–	–	–	–	used	–	–	–
PCIe16_1	used	–	–	–	–	–	–	–
PCIe16_2	–	–	–	–	–	–	used	–

#### ICH

	A	B	C	D	E	F	G	H
PCIe16_3	–	shared	–	–	–	–	–	–
PCIe1_1	shared	–	–	–	–	–	–	–
LAN1 (8056)	–	–	shared	–	–	–	–	–
LAN2 (8056)	–	shared	–	–	–	–	–	–
Marvell 6111	shared	–	–	–	–	–	–	–
Marvell SAS	–	–	–	shared	–	–	–	–
PCI_1	shared	–	–	–	–	–	–	–
PCI_2	–	shared	–	–	–	–	–	–
USB_1	–	–	–	–	–	–	–	shared
USB_2	–	–	–	shared	–	–	–	–
USB_3	–	–	shared	–	–	–	–	–
USB_4	shared	–	–	–	–	–	–	–
USB_5	–	–	–	–	–	used	–	–
USB_6	–	–	–	shared	–	–	–	–
USB 2.0_1	–	–	–	–	–	–	–	shared
USB 2.0_2	–	–	shared	–	–	–	–	–
SATA_1	–	–	–	–	shared	–	–	–
SATA_2	–	–	–	–	shared	–	–	–
Audio	–	–	–	–	–	–	used	–

## 2.5.4 PCI slots

The PCI slots support cards such as a LAN card, SCSI card, USB card, and other cards that comply with PCI specifications. Refer to the figure below for the location of the slots.

## 2.5.5 PCI Express x1 slot

This motherboard supports PCI Express x1 network cards, SCSI cards and other cards that comply with the PCI Express specifications. Refer to the figure below for the location of the slots.

## 2.5.6 PCI Express 2.0 x16 slots

This motherboard has three PCI Express 2.0 x16 slots that support PCI Express x16 2.0 graphic cards complying with the PCI Express specifications. Refer to the figure below for the location of the slots.

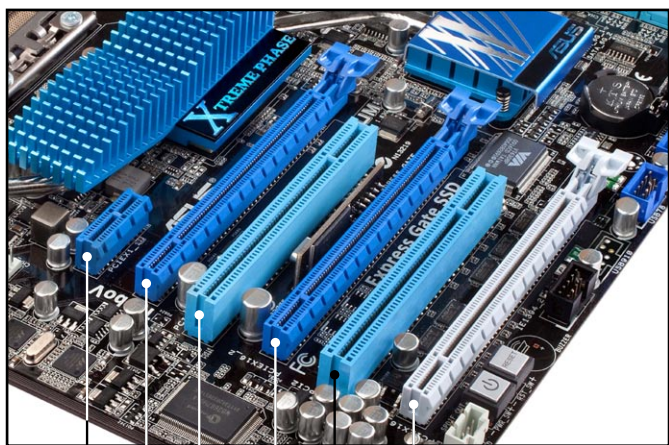

PCIe 2.0 x16\_3 slot (gray, at max. x8 link)  
PCI slot 2  
PCIe 2.0 x16\_2 slot (blue, at max. x16 link)  
PCI slot 1  
PCIe 2.0 x16\_1 slot (blue, at x16 link)  
PCIe x1\_1 slot



VGA configuration	PCI Express operating mode		
	PCIe x16_1	PCIe x16_2	PCIe x16_3
Single VGA/PCIe card	x16 (Recommend for single VGA)	x16 (Single VGA)	N/A
Dual VGA/PCIe card	x16	x16	x1
Triple VGA/PCIe card	x16	x16	x1
	x16	x8	x8



- In single VGA card mode, use first the PCIe 2.0 x16\_1 slot (blue) or PCIe 2.0 x16\_2 slot (blue) for a PCI Express x16 graphics card to get better performance.
- In CrossFireX™ or SLI™ mode, use the PCIe 2.0 x16\_1 (blue) and PCIe 2.0 x16\_2 (blue) slots for PCI Express x16 graphics cards to get better performance.
- Use the three PCIe 2.0 x16 slots for 3-Way SLI or CrossFireX™ mode.
- If you install a PCIe x16 graphics card on to the PCIe x16\_1 slot, a PCIe device with a bandwidth faster than x8 link to the PCIe x16\_2 slot, and a PCIe device with a bandwidth slower than x4 link to the PCIe x16\_3 slot, the three PCIe x16 slots will work at x16, x16, x1 link as the default.
- If you install a PCIe x16 graphics card on to the PCIe x16\_1 slot, a PCIe device with a bandwidth slower than x8 link to the PCIe x16\_2 slot, and a PCIe device with a bandwidth faster than x4 link to the PCIe x16\_3 slot, the three PCIe x16 slots will work at x16, x8, x8 link as the default.
- You may manually reassign the link width of PCIe x16\_2 and PCIe x16\_3 slots in BIOS settings. See page 3-22 for details.
- We recommend that you provide sufficient power when running CrossFireX™ or SLI™ mode. See page 2-35 for details.
- Connect a chassis fan to the motherboard connector labeled CHA\_FAN1/2/3 when using multiple graphics cards for better thermal environment. See page 2-33 for details.

## 2.6 Jumpers

### CPU / DRAM Bus / QPI DRAM overvoltage setting (3-pin OV\_CPU, 3-pin OV\_DRAM\_BUS, 3-pin OV\_QPI\_DRAM)

These jumpers allow you to enable or disable the advanced CPU, DRAM Bus, and QPI DRAM overvoltage settings in BIOS. Read the following information before you change the jumper settings.

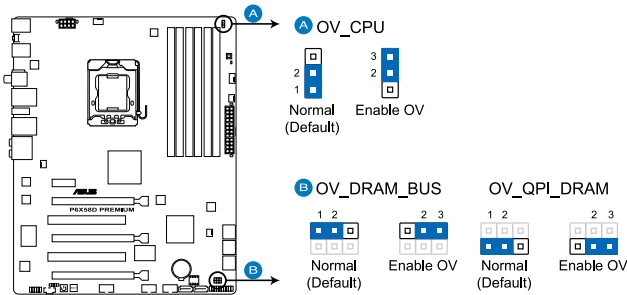

**P6X58D PREMIUM CPU/DRAM BUS/QPI DRAM overvoltage settings**

	OV_CPU	OV_DRAM_BUS	OV_QPI_DRAM
Pins 1-2 (Default)	up to 1.70V	up to 2.00V	up to 1.70V
Pins 2-3 (OV Enabled)	up to 2.10V	up to 2.46V	up to 1.90V



- Before you change the jumper settings for extra-high overvoltage ability, use the BIOS items first to adjust the desired CPU, DRAM, and QPI performance. Ensure that your system functions well under the highest BIOS voltage settings before you change the setting of these three jumpers.
- DO NOT set the OV\_CPU jumper to pins 2–3 when you install a new CPU and have not booted for the first time. Doing so may cause the system to halt. For system failure due to the wrong setting of the OV\_CPU jumper, shut down the computer and move the cap back to pins 1–2.
- According to Intel CPU spec, DIMMs with voltage requirement over 1.65V may damage the CPU permanently. We recommend you install the DIMMs with the voltage requirement below 1.65V.
- The system may need a better cooling system (for example, a water-cooling system) to work stably under high voltage settings.

## 2.7 Onboard switches

Onboard switches allow you to fine-tune performance when working on a bare or open-case system. This is ideal for overclockers and gamers who continually change settings to enhance system performance.

### 1. Power-on switch

The motherboard comes with a power-on switch that allows you to power up or wake up the system. This switch also lights up when the system is plugged to a power source indicating that you should shut down the system and unplug the power cable before removing or plugging in any motherboard component. The illustration below shows the location of the onboard power-on switch.

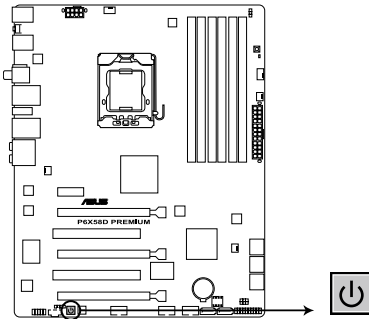

**P6X58D PREMIUM Power on switch**

### 2. Reset switch

Press the reset switch to reboot the system.

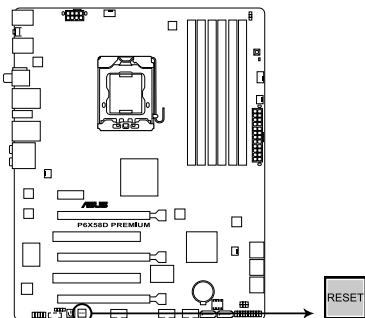

**P6X58D PREMIUM Reset switch**

### 3. MemOK! switch

Installing DIMMs that are incompatible with the motherboard may cause system boot failure, and the DRAM\_LED near the MemOK! switch lights continuously. Press and hold the MemOK! switch until the DRAM\_LED starts blinking to begin automatic memory compatibility tuning for successful boot.

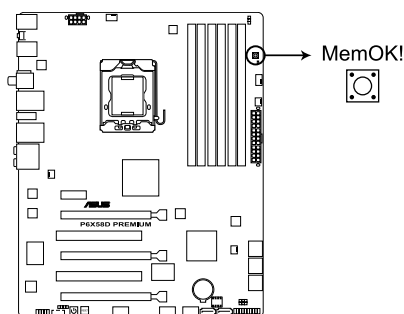

**P6X58D PREMIUM MemOK! switch**



- The DRAM\_LED also lights when the DIMM is not properly installed. Turn off the system and reinstall the DIMM before using the MemOK! function.
- Pressing the MemOK! switch under Windows® OS environment will reboot the computer and start the memory tuning.
- During the tuning process, the system loads and tests failsafe memory settings. It takes about 30 seconds for the system to test one set of failsafe settings. If the test fails, the system reboots and test the next set of failsafe settings. The blinking speed of the DRAM\_LED increases, indicating different test processes.
- Due to memory tuning requirement, the system automatically reboots when each timing set is tested. If the installed DIMMs still fail to boot after the whole tuning process, the DRAM\_LED lights continuously. Replace the DIMMs with ones recommended in the Memory QVL (Qualified Vendors Lists) in this user manual or on the ASUS website at [www.asus.com](http://www.asus.com).
- If you turn off the computer and replace DIMMs during the tuning process, the system continues memory tuning after turning on the computer. To stop memory tuning, turn off the computer and unplug the power cord for about 5–10 seconds.
- If your system fail to boot due to BIOS overlocking, press the MemOK! switch to boot and load BIOS default settings. A message will appear during POST reminding you that the BIOS has been restored to its default settings.
- We recommend that you download and update to the latest BIOS version from the ASUS website at [www.asus.com](http://www.asus.com) after using the MemOK! function.

## 2.8 Connectors

### 2.8.1 Rear panel connectors

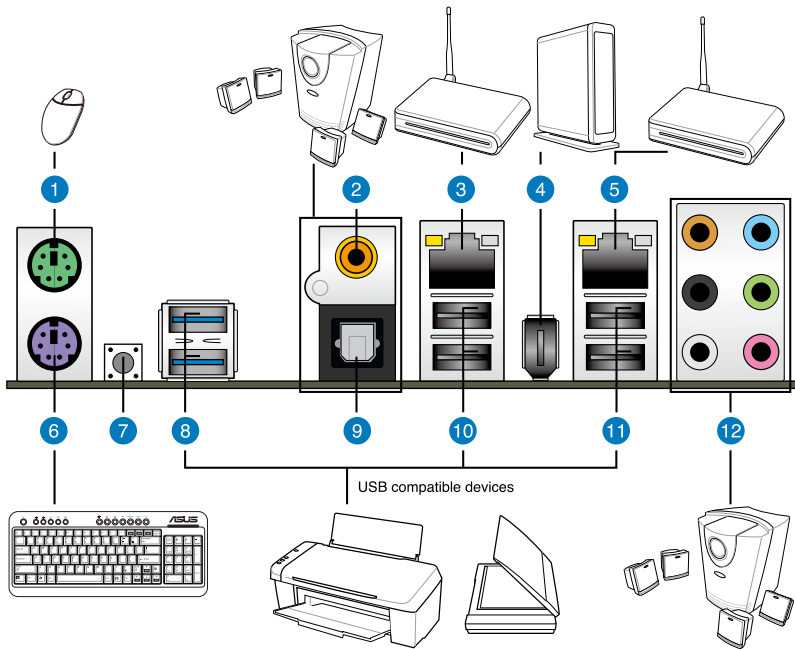

#### Rear panel connectors

1. PS/2 mouse port (green)	7. Clear CMOS switch
2. Coaxial S/PDIF Out port	8. USB 3.0 ports 1 and 2
3. LAN2 (RJ-45) port*	9. Optical S/PDIF Out port
4. IEEE 1394a port	10. USB 2.0 ports 3 and 4
5. LAN1 (RJ-45) port*	11. USB 2.0 ports 1 and 2
6. PS/2 keyboard port (purple)	12. Audio I/O ports**

\*and \*\*: Refer to the tables on the next page for LAN port and audio port definitions.



Press the Clear CMOS switch to clear BIOS setup information only when the system hangs due to overclocking.

## \* LAN port LED indications

Activity Link LED		Speed LED	
Status	Description	Status	Description
OFF	No link	OFF	10 Mbps connection
ORANGE	Linked	ORANGE	100 Mbps connection
BLINKING	Data activity	GREEN	1 Gbps connection

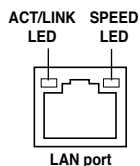

## \*\* Audio 2, 4, 6, or 8-channel configuration

Port	Headset 2-channel	4-channel	6-channel	8-channel
Light Blue	Line In	Line In	Line In	Line In
Lime	Line Out	Front Speaker Out	Front Speaker Out	Front Speaker Out
Pink	Mic In	Mic In	Mic In	Mic In
Orange	–	–	Center/Subwoofer	Center/Subwoofer
Black	–	Rear Speaker Out	Rear Speaker Out	Rear Speaker Out
Gray	–	–	–	Side Speaker Out

## 2.8.2 Audio I/O connections

### Audio I/O ports

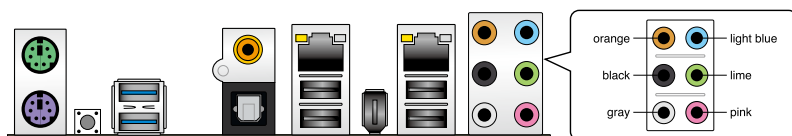

### Connect to Headphone and Mic

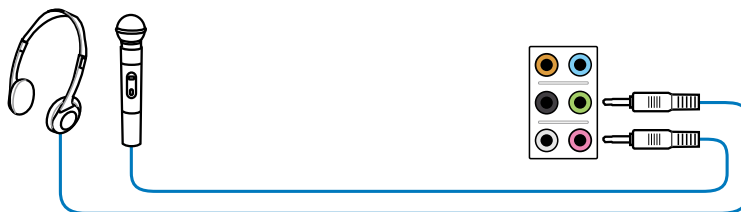

### Connect to Stereo Speakers

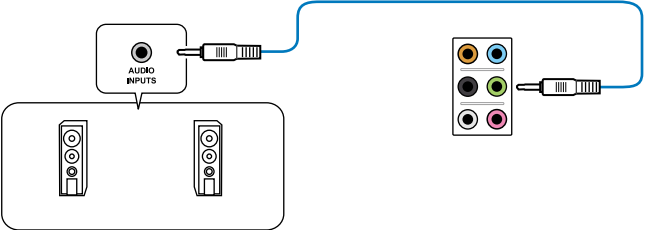

### Connect to 2.1 channel Speakers

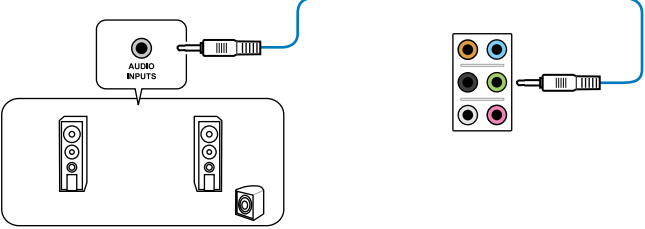

### Connect to 4.1 channel Speakers

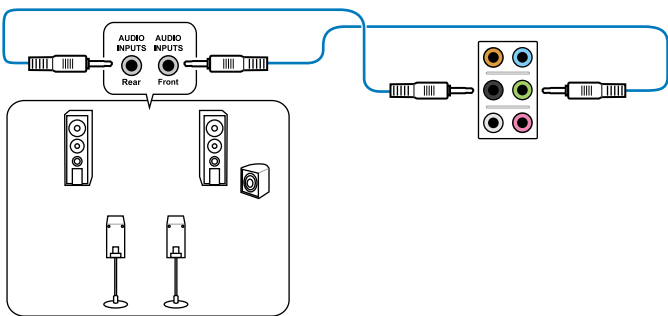

## Connect to 5.1 channel Speakers

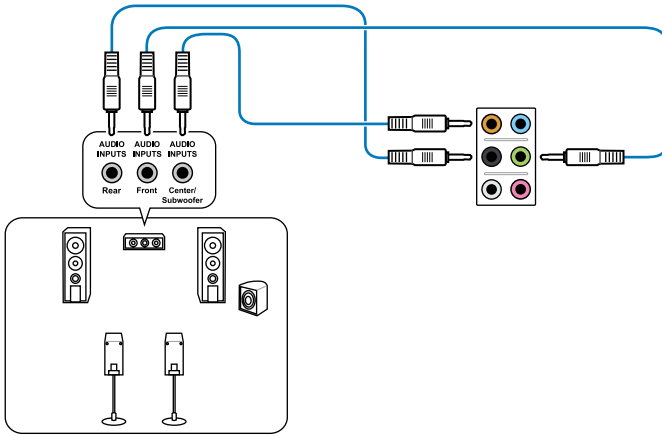

## Connect to 7.1 channel Speakers

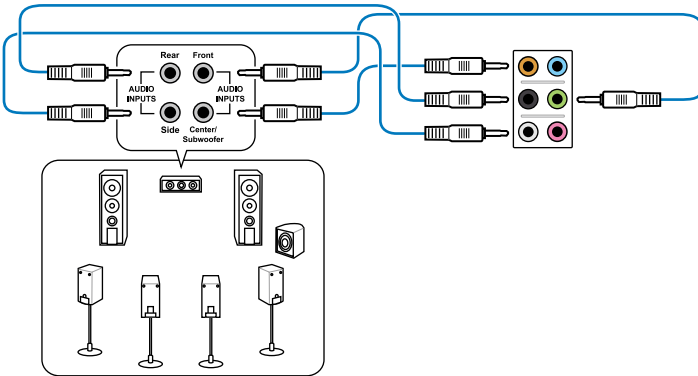



## 2.8.3 Internal connectors

### 1. ICH10R Serial ATA connectors (7-pin SATA 1–6 [blue])

These connectors are for the Serial ATA signal cables for Serial ATA hard disk drives and optical disc drives.

If you installed Serial ATA hard disk drives, you can create a RAID 0, 1, 5, and 10 configuration with the Intel® Matrix Storage Technology through the onboard Intel® ICH10R RAID controller.

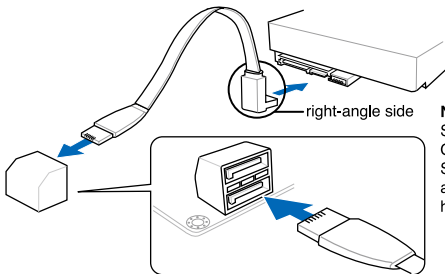
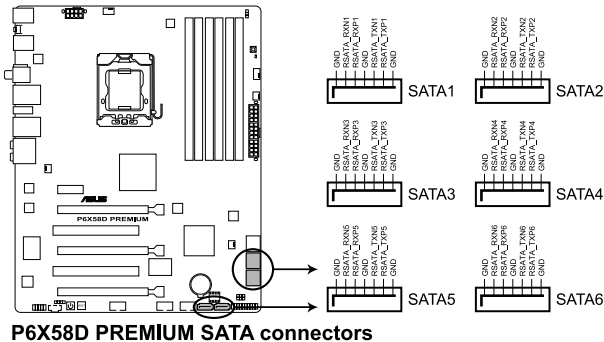

**NOTE:** Connect the right-angle side of SATA signal cable to SATA device. Or you may connect the right-angle side of SATA cable to the onboard SATA port to avoid mechanical conflict with huge graphics cards.



- These connectors are set to Standard IDE mode by default. In Standard IDE mode, you can connect Serial ATA boot/data hard disk drives to these connectors. If you intend to create a Serial ATA RAID set using these connectors, set the **Configure SATA** as item in the BIOS to [RAID]. See section 3.4.2 **Storage Configuration** for details.
- Before creating a RAID set, refer to section 4.4 **RAID configurations** or the manual bundled in the motherboard support DVD.
- You must install Windows® XP Service Pack 2 or later version before using Serial ATA hard disk drives. The Serial ATA RAID feature is available only if you are using Windows® XP SP 2 or later version.
- When using hot-plug and NCQ, set the **Configure SATA** as in the BIOS to [AHCI]. See section 3.4.2 **Storage Configuration** for details.

## 2. Marvell® Serial ATA 6.0 Gb/s connectors (7-pin SATA\_6G\_1, 7-pin SATA\_6G\_2 [gray])

These connectors are for the Serial ATA 6.0 Gb/s signal cables for Serial ATA 6.0 Gb/s hard disk drives.

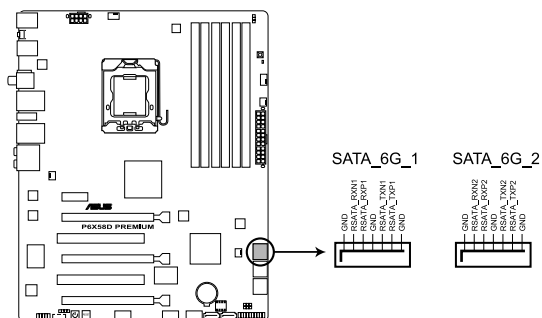

**P6X58D PREMIUM SATA 6G connectors**



- These connectors are set to Standard IDE mode by default. In Standard IDE mode, you can connect Serial ATA data hard disk drives to these connectors.
- You must install Windows® XP Service Pack 2 or later versions before using Serial ATA hard disk drives.
- When using hot-plug and NCQ, set the **Marvell 9123 Controller** item in the BIOS to [AHCI Mode]. Refer to section **3.6.3 Onboard Devices Configuration** for details.

### 3. USB connectors (10-1 pin USB56; USB78)

These connectors are for USB 2.0 ports. Connect the USB module cable to any of these connectors, then install the module to a slot opening at the back of the system chassis. These USB connectors comply with USB 2.0 specification that supports up to 480 Mbps connection speed.

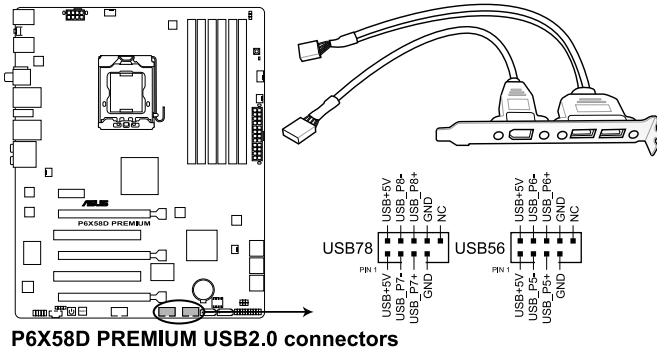

Never connect a 1394 cable to the USB connectors. Doing so will damage the motherboard!



You can connect the front panel USB cable to the ASUS Q-Connector (USB, blue) first, and then install the Q-Connector (USB) to the USB connector onboard if your chassis supports front panel USB ports.



The USB module cable is purchased separately.

#### 4. IEEE 1394a port connector (10-1 pin IE1394\_2)

This connector is for an IEEE 1394a port. Connect the IEEE 1394a module cable to this connector, then install the module to a slot opening at the back of the system chassis.

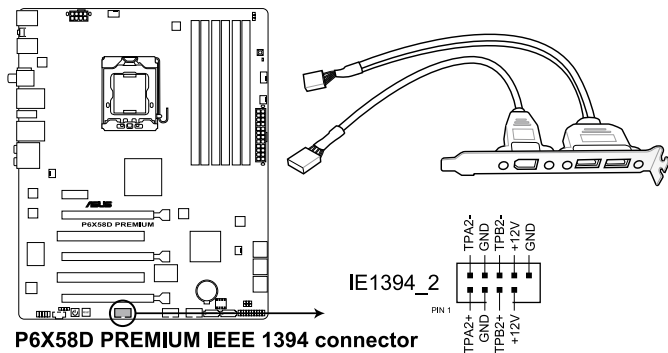

Never connect a USB cable to the IEEE 1394a connector. Doing so will damage the motherboard!



The IEEE 1394a module cable is purchased separately.

#### 5. Optical drive audio connector (4-pin CD)

These connectors allow you to receive stereo audio input from sound sources such as a CD-ROM, TV tuner, or MPEG card.

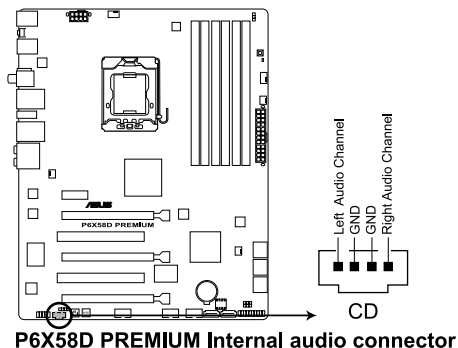

## 6. CPU, chassis, and power fan connectors (4-pin CPU\_FAN; 4-pin CHA\_FAN1; 3-pin CHA\_FAN2-3; 3-pin PWR\_FAN)

Connect the fan cables to the fan connectors on the motherboard, ensuring that the black wire of each cable matches the ground pin of the connector.

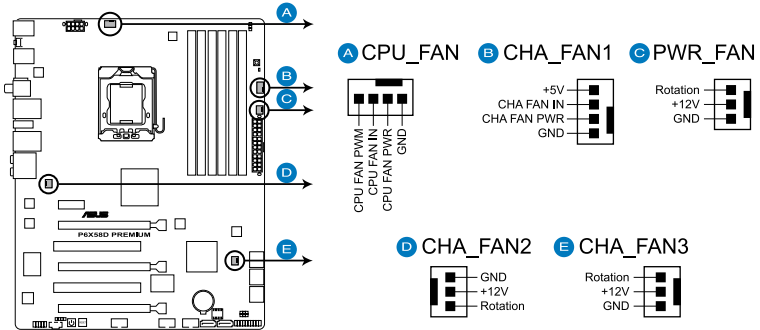

**P6X58D PREMIUM Fan connectors**



Do not forget to connect the fan cables to the fan connectors. Insufficient air flow inside the system may damage the motherboard components. These are not jumpers! Do not place jumper caps on the fan connectors!



- The CPU\_FAN connector supports the CPU fan of maximum 2A (24 W) fan power.
- Only the CPU\_FAN, CHA\_FAN 1, CHA\_FAN 2 and CHA\_FAN 3 connectors support the ASUS Fan Xpert feature.
- If you install two VGA cards, we recommend that you plug the rear chassis fan cable to the motherboard connector labeled CHA\_FAN1/2/3 for better thermal environment.

## 7. Digital audio connector (4-1 pin SPDIF\_OUT)

This connector is for an additional Sony/Philips Digital Interface (S/PDIF) port. Connect the S/PDIF Out module cable to this connector, then install the module to a slot opening at the back of the system chassis.

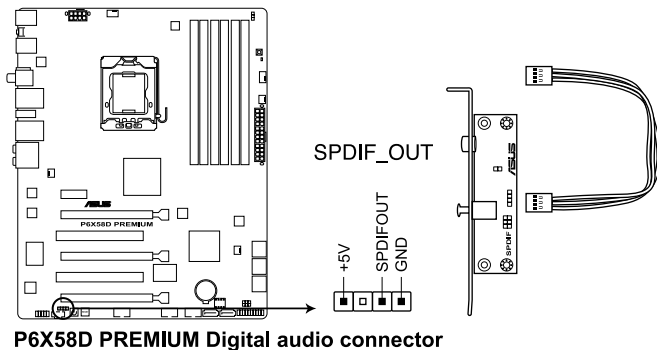

**P6X58D PREMIUM Digital audio connector**



The S/PDIF module is purchased separately.

## 8. Front panel audio connector (10-1 pin AAFP)

This connector is for a chassis-mounted front panel audio I/O module that supports either HD Audio or legacy AC '97 audio standard. Connect one end of the front panel audio I/O module cable to this connector.

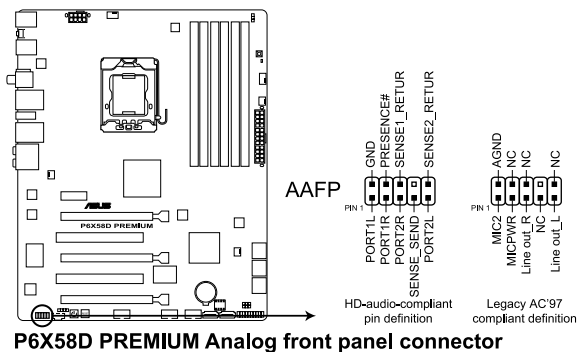

**P6X58D PREMIUM Analog front panel connector**



- We recommend that you connect a high-definition front panel audio module to this connector to avail of the motherboard's high-definition audio capability.
- If you want to connect a high-definition front panel audio module to this connector, set the **Front Panel Type** item in the BIOS setup to **[HD Audio]**; if you want to connect an AC'97 front panel audio module to this connector, set the item to **[AC97]**. By default, this connector is set to **[HD Audio]**.

## 9. ATX power connectors (24-pin EATXPWR; 8-pin EATX12V)

These connectors are for ATX power supply plugs. The power supply plugs are designed to fit these connectors in only one orientation. Find the proper orientation and push down firmly until the connectors completely fit.

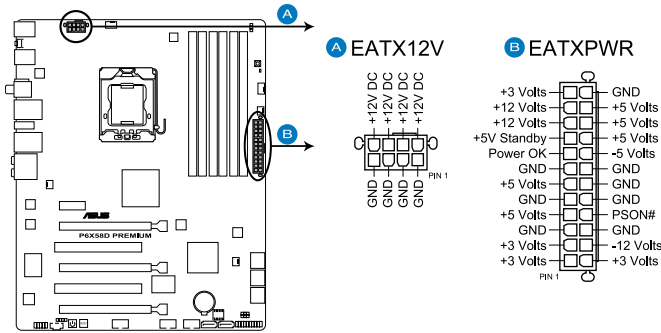

**P6X58D PREMIUM ATX power connectors**



- For a fully configured system, we recommend that you use a power supply unit (PSU) that complies with ATX 12 V Specification 2.0 (or later version) and provides a minimum power of 350 W.
- Do not forget to connect the 8-pin EATX12 V power plug; otherwise, the system will not boot.
- We recommend that you use a PSU with higher power output when configuring a system with more power-consuming devices. The system may become unstable or may not boot up if the power is inadequate.
- If you want to use two or more high-end PCI Express x16 cards, use a PSU with 1000W power or above to ensure the system stability.
- If you are uncertain about the minimum power supply requirement for your system, refer to the Recommended Power Supply Wattage Calculator at <http://support.asus.com/PowerSupplyCalculator/PSCalculator.aspx?SLanguage=en-us> for details.

### PSU suggested list:

Seventeam ST-522HLP	OCZ OCZGXS850	Seasonic SS-500HM
Seventeam ST550EAJ-05F	OCZ OCZ1000PXS	Seasonic SS-550HT
Antec SG-850	Seasonic SS-850EM	Seasonic SS-600HT
ASUS P-50GA	Silverstone SST-ST85F	Seventeam ST-420BKP
ASUS U-75HA	Tagan TG1100-U33	Snake PSH500V
Be quiet P6-PRO-850W	Thermaltake W0132RE	Silverstone SST-ST50EF
Be quiet BN077	Thermaltake W0133RU	Silverstone PSU ST56ZF
CoolerMaster RS-850EMBA	Aelta GPS-550AB	T.C. STAR D420
Corsair CMPSU-620HX	Antec EA-380	Thermaltake TWV500W-AP
EnerMAX EGX1000EWL	OCZ OCZ780MXS	Thermaltake PUREPower-600AP
HECHUAN ST-ATX330	Seasonic SS-351HT	Zalman ZM600-HP
HUNTKEY 磐石500	Seasonic SS-460HS	Zippy HP2-6500PE (G1)
Be quiet P6-PRO-850W	Seasonic SS-500GB	Zippy PSL6720P

## 10. System panel connector (20-8 pin PANEL)

This connector supports several chassis-mounted functions.

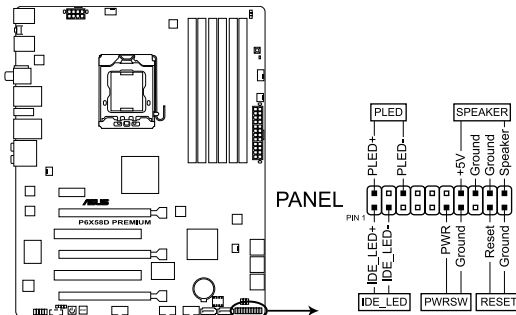

**P6X58D PREMIUM System panel connector**

- **System power LED (2-pin PLED)**

This 2-pin connector is for the system power LED. Connect the chassis power LED cable to this connector. The system power LED lights up when you turn on the system power, and blinks when the system is in sleep mode.

- **Hard disk drive activity LED (2-pin IDE\_LED)**

This 2-pin connector is for the HDD Activity LED. Connect the HDD Activity LED cable to this connector. The IDE LED lights up or flashes when data is read from or written to the HDD.

- **System warning speaker (4-pin SPEAKER)**

This 4-pin connector is for the chassis-mounted system warning speaker. The speaker allows you to hear system beeps and warnings.

- **ATX power button/soft-off button (2-pin PWRSW)**

This connector is for the system power button. Pressing the power button turns the system on or puts the system in sleep or soft-off mode depending on the BIOS settings. Pressing the power switch for more than four seconds while the system is ON turns the system OFF.

- **Reset button (2-pin RESET)**

This 2-pin connector is for the chassis-mounted reset button for system reboot without turning off the system power.



## 2.8.4 ASUS Q-Connector (system panel)

Use the ASUS Q-Connector to connect/disconnect the chassis front panel cables.

To install the ASUS Q-Connector:

1. Connect the front panel cables to the ASUS Q-Connector.

Refer to the labels on the Q-Connector to know the detailed pin definitions, and then match them to their respective front panel cable labels.



The labels on the front panel cables may vary depending on the chassis model.

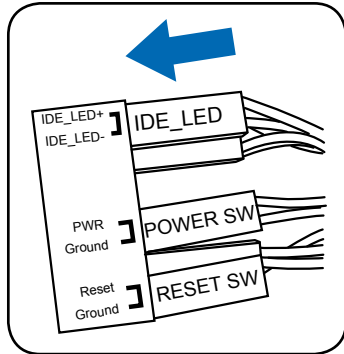

2. Install the ASUS Q-Connector to the system panel connector, ensuring the orientation matches the labels on the motherboard.

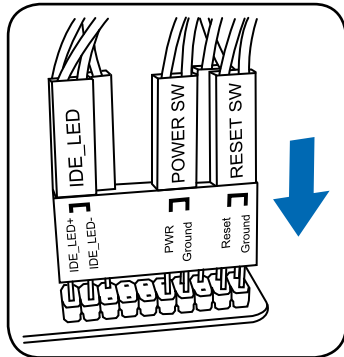

3. The front panel functions are now enabled. The figure shows the Q-Connector is properly installed on the motherboard.

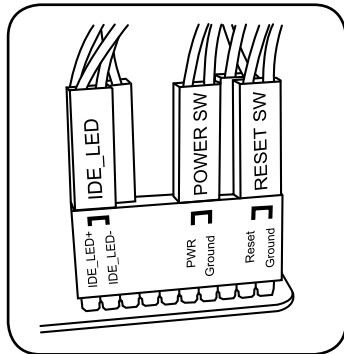

## 2.9 Starting up for the first time

1. After making all the connections, replace the system case cover.
2. Be sure that all switches are off.
3. Connect the power cord to the power connector at the back of the system chassis.
4. Connect the power cord to a power outlet that is equipped with a surge protector.
5. Turn on the devices in the following order:
  - a. Monitor
  - b. External SCSI devices (starting with the last device on the chain)
  - c. System power
6. After applying power, the system power LED on the system front panel case lights up. For systems with ATX power supplies, the system LED lights up when you press the ATX power button. If your monitor complies with the “green” standards or if it has a “power standby” feature, the monitor LED may light up or change from orange to green after the system LED turns on.

The system then runs the power-on self tests or POST. While the tests are running, the BIOS beeps (see the BIOS beep codes table below) or additional messages appear on the screen. If you do not see anything within 30 seconds from the time you turned on the power, the system may have failed a power-on test. Check the jumper settings and connections or call your retailer for assistance.

BIOS Beep	Description
One short beep	VGA detected Quick boot set to disabled No keyboard detected
One continuous beep followed by two short beeps then a pause (repeated)	No memory detected
One continuous beep followed by three short beeps	No VGA detected
One continuous beep followed by four short beeps	Hardware component failure

7. At power on, hold down the <Delete> key to enter the BIOS Setup. Follow the instructions in Chapter 3.

## 2.10 Turning off the computer

While the system is ON, pressing the power switch for less than four seconds puts the system on sleep mode or soft-off mode, depending on the BIOS setting. Pressing the power switch for more than four seconds lets the system enter the soft-off mode regardless of the BIOS setting. Refer to section **3.7 Power menu** in Chapter 3 for details.

## 3.1 Knowing BIOS

BIOS (Basic Input and Output System) stores system hardware settings such as storage device configuration, overlocking settings, advanced power management, and boot device configuration that are needed for system startup in the motherboard CMOS. In normal circumstances, the default BIOS settings apply to most conditions to ensure optimum performance. **We recommend that you not change the default BIOS settings** except in the following circumstances:

- An error message appears on the screen during the system bootup and requests you to run the BIOS Setup.
- You have installed a new system component that requires further BIOS settings or update.



---

Inappropriate settings of the BIOS may result to instability or failure to boot. **We strongly recommend that you change the BIOS settings only with the help of a trained service personnel.**

---

## 3.2 Updating BIOS

The ASUS website publishes the latest BIOS versions to provide enhancements on system stability, compatibility, or performance. However, BIOS updating is potentially risky. If there is no problem using the current version of BIOS, **DO NOT manually update the BIOS.** Inappropriate BIOS updating may result in the system's failure to boot. Carefully follow the instructions of this chapter to update your BIOS if necessary.



---

Visit the ASUS website ([www.asus.com](http://www.asus.com)) to download the latest BIOS file for this motherboard.

---

The following utilities allow you to manage and update the motherboard BIOS setup program.

1. **ASUS Update:** Updates the BIOS in Windows® environment.
2. **ASUS EZ Flash 2:** Updates the BIOS using a USB flash drive.
3. **ASUS CrashFree BIOS 3 utility:** Restores the BIOS using the motherboard support DVD or a USB flash drive when the BIOS file fails or gets corrupted.

Refer to the corresponding sections for details on these utilities.



---

Save a copy of the original motherboard BIOS file to a USB flash disk in case you need to restore the BIOS in the future. Copy the original motherboard BIOS using the **ASUS Update** utility.

---

### 3.2.1 ASUS Update utility

The ASUS Update is a utility that allows you to manage, save, and update the motherboard BIOS in Windows® environment. The ASUS Update utility allows you to:

- Save the current BIOS file
- Download the latest BIOS file from the Internet
- Update the BIOS from an updated BIOS file
- Update the BIOS directly from the Internet
- View the BIOS version information

This utility is available in the support DVD that comes with the motherboard package.



ASUS Update requires an Internet connection either through a network or an Internet Service Provider (ISP).

### Installing ASUS Update

To install ASUS Update:

1. Place the support DVD in the optical drive.
2. From the **Main** menu, click the **Utilities** tab, then click **Install ASUS Update VX.XX.XX**.
3. The ASUS Update utility is copied to your system.



Quit all Windows® applications before you update the BIOS using this utility.

### Updating the BIOS through the Internet

To update the BIOS through the Internet:

1. From the Windows® desktop, click **Start > Programs > ASUS > ASUSUpdate > ASUSUpdate**. The ASUS Update main window appears.
2. Select **Update BIOS from the Internet** from the drop-down menu, and then click **Next**.

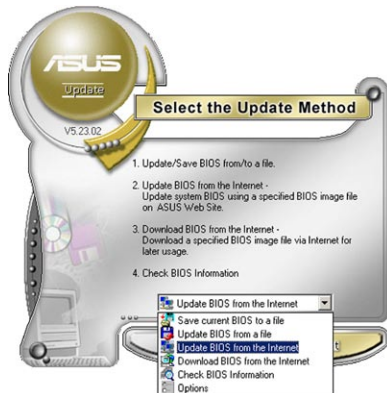
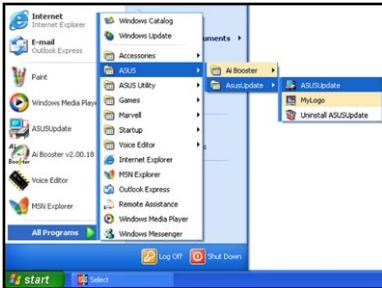

3. Select the ASUS FTP site nearest you to avoid network traffic, or click **Auto Select**. Click **Next**.



4. From the FTP site, select the BIOS version that you wish to download. Click **Next**.



5. Follow the onscreen instructions to complete the update process.



The ASUS Update utility is capable of updating itself through the Internet. Always update the utility to avail all its features.

## Updating the BIOS through a BIOS file

To update the BIOS through a BIOS file:

1. From the Windows® desktop, click **Start > Programs > ASUS > ASUSUpdate > ASUSUpdate**. The ASUS Update main window appears.
2. Select **Update BIOS from a file** from the dropdown menu, then click **Next**.
3. Locate the BIOS file from the Open window, then click **Open**.
4. Follow the onscreen instructions to complete the update process.

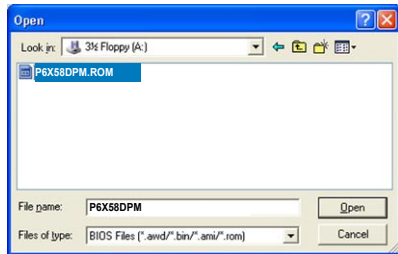
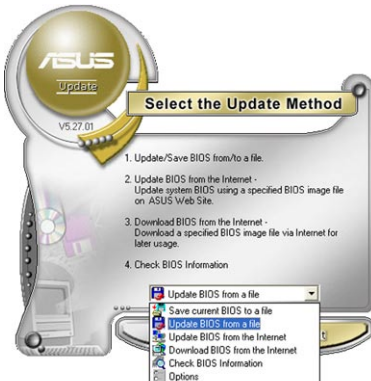

Ensure to load the BIOS default settings to ensure system compatibility and stability. Select the **Load Setup Defaults** item under the Exit menu. See section 3.10 **Exit Menu** for details.

## 3.2.2 ASUS EZ Flash 2 utility

The ASUS EZ Flash 2 feature allows you to update the BIOS without having to use a bootable floppy disk or an OS-based utility.



Before you start using this utility, download the latest BIOS from the ASUS website at [www.asus.com](http://www.asus.com).

To update the BIOS using EZ Flash 2:

1. Insert the USB flash disk that contains the latest BIOS file to the USB port, and then launch EZ Flash 2 in any of these two ways:
  - Press <Alt> + <F2> during POST to display the following.
  - Enter the BIOS setup program. Go to the **Tools** menu to select **EZ Flash 2** and press <Enter> to enable it.

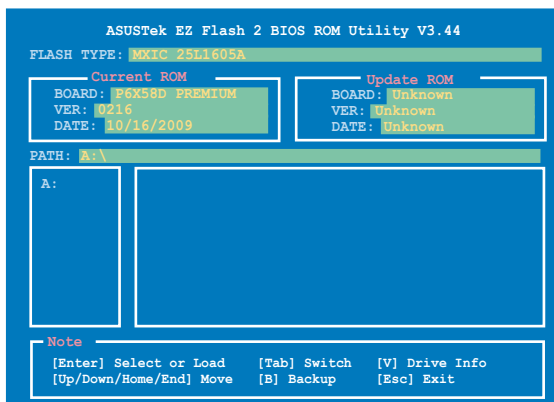

2. Press <Tab> to switch between drives until the correct BIOS file is found. When the correct BIOS file is found, EZ Flash 2 performs the BIOS update process and automatically reboots the system when done.



- This function can support devices such as a USB flash disk with FAT 32/16 format and single partition only.
- DO NOT shut down or reset the system while updating the BIOS to prevent system boot failure!



Ensure to load the BIOS default settings to ensure system compatibility and stability. Select the **Load Setup Defaults** item under the **Exit** menu. See section 3.10 **Exit Menu** for details.

### 3.2.3 ASUS CrashFree BIOS 3 utility

The ASUS CrashFree BIOS 3 utility is an auto recovery tool that allows you to restore the BIOS file when it fails or gets corrupted during the updating process. You can restore a corrupted BIOS file using the motherboard support DVD or a USB flash drive that contains the BIOS file.



---

The BIOS file in the motherboard support DVD may be older than the BIOS file published on the ASUS official website. If you want to use the newer BIOS file, download the file at [support.asus.com](http://support.asus.com) and save it to a USB flash drive.

---

#### Recovering the BIOS

To recover the BIOS:

1. Turn on the system.
2. Insert the motherboard support DVD to the optical drive, or the USB flash drive containing the BIOS file to the USB port.
3. The utility automatically checks the devices for the BIOS file. When found, the utility reads the BIOS file and starts flashing the corrupted BIOS file.
4. Turn off the system after the utility completes the updating process and power on again.
5. The system requires you to enter BIOS Setup to recover BIOS setting. To ensure system compatibility and stability, we recommend that you press <F2> to load default BIOS values.



---

**DO NOT** shut down or reset the system while updating the BIOS! Doing so can cause system boot failure!

---

### 3.3 BIOS setup program

A BIOS Setup program is provided for BIOS item modification. When you start up the computer, the system provides you with the opportunity to run this program. Press <Del> during the Power-On Self-Test (POST) to enter the Setup utility. Otherwise, POST continues with its test routines.

If you wish to enter Setup after POST, restart the system by pressing <Ctrl> + <Alt> + <Delete>, or by pressing the reset button on the system chassis. You can also restart by turning the system off and then back on. Do this last option only if the first two failed.

The Setup program is designed to make it as easy to use as possible. Being a menu-driven program, it lets you scroll through the various submenus and select from the available options using the navigation keys.



- The BIOS setup screens shown in this section are for reference purposes only, and may not exactly match what you see on your screen.
- If the system becomes unstable after changing any BIOS setting, load the default settings to ensure system compatibility and stability. Select the **Load Setup Defaults** item under the **Exit** menu. See section 3.10 **Exit Menu** for details.
- If the system fails to boot after changing any BIOS setting, try to clear the CMOS and reset the motherboard to the default value. See section 2.7.1 **Rear panel connectors** for information on how to erase the RTC RAM.

#### 3.3.1 BIOS menu screen

#### 3.3.2 Menu bar

The menu bar on top of the screen has the following main items:

Main	For changing the basic system configuration
Ai Tweaker	For changing the overclocking settings
Advanced	For changing the advanced system settings
Power	For changing the advanced power management (APM) configuration
Boot	For changing the system boot configuration
Tools	For configuring options for special functions
Exit	For selecting the exit options and loading default settings



### 3.3.3 Navigation keys

At the bottom right corner of a menu screen are the navigation keys for that particular menu. Use the navigation keys to select items in the menu and change the settings.



The navigation keys may differ from one screen to another.

### 3.3.4 Menu items

The highlighted item on the menu bar displays the specific items for that menu. For example, selecting **Main** shows the Main menu items.

The other items (Ai Tweaker, Advanced, Power, Boot, Tools, and Exit) on the menu bar have their respective menu items.

### 3.3.5 Submenu items

A solid triangle before each item on any menu screen means that the item has a submenu. To display the submenu, select the item and press <Enter>.

### 3.3.6 Configuration fields

These fields show the values for the menu items. If an item is user-configurable, you can change the value of the field opposite the item. You cannot select an item that is not user-configurable.

A configurable field is enclosed in brackets, and is highlighted when selected. To change the value of a field, select it and press <Enter> to display a list of options. Refer to **3.3.7 Pop-up window**.

### 3.3.7 Pop-up window

Select a menu item and press <Enter> to display a pop-up window with the configuration options for that item.

### 3.3.8 Scroll bar

A scroll bar appears on the right side of a menu screen when there are items that do not fit on the screen. Press the Up/Down arrow keys or <Page Up> / <Page Down> keys to display the other items on the screen.

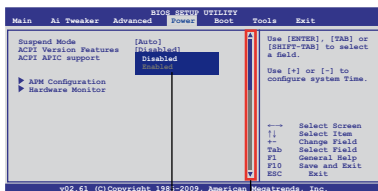

Pop-up window  
Scroll bar

### 3.3.9 General help

At the top right corner of the menu screen is a brief description of the selected item.

### 3.4 Main menu

When you enter the BIOS Setup program, the Main menu screen appears, giving you an overview of the basic system information. Select an item and press <Enter> to display the submenu.



Refer to **section 3.3.1 BIOS menu screen** for information on the menu screen items and how to navigate through them.

BIOS SETUP UTILITY		
Main	Ai Tweaker	Advanced Power Boot Tools Exit
System Time	[13:51:25]	Use [ENTER], [TAB] or [SHIFT-TAB] to select a field.
System Date	[Fri 10/23/2009]	
Language	[English]	
▶ SATA1	[HDT722516DLA380]	Use [+] or [-] to configure system Date.
▶ SATA2	[Not Detected]	
▶ SATA3	[Not Detected]	
▶ SATA4	[Not Detected]	
▶ SATA5	[Not Detected]	
▶ SATA6	[Not Detected]	
▶ Storage Configuration		←→ Select Screen ↑↓ Select Item +- Change Field Tab Select Field F1 General Help F10 Save and Exit ESC Exit
▶ System Information		
v02.61 (C)Copyright 1985-2009, American Megatrends, Inc.		

#### 3.4.1 SATA 1-6

While entering Setup, the BIOS automatically detects the presence of SATA devices. There is a separate submenu for each SATA device. Select a device item and press <Enter> to display the SATA device information.

BIOS SETUP UTILITY		
Main		
<b>SATA 1</b>		
Device	: Hard Disk	Select the type of device connected to the system.
Vendor	: HDT722516DLA380	
Size	: 164.7GB	
LBA Mode	: Supported	
Block Mode	: 16Sectors	
PIO Mode	: 4	
Async DMA	: MultiWord DMA-2	
Ultra DMA	: Ultra DMA-6	
SMART Monitoring	: Supported	
Type	[Auto]	
LBA/Large Mode	[Auto]	
Block(Multi-sector Transfer)M	[Auto]	
PIO Mode	[Auto]	
DMA Mode	[Auto]	
SMART Monitoring	[Auto]	
32Bit Data Transfer	[Enabled]	
v02.61 (C)Copyright 1985-2009, American Megatrends, Inc.		

The BIOS automatically detects the values opposite the dimmed items (Device, Vendor, Size, LBA Mode, Block Mode, PIO Mode, Async DMA, Ultra DMA, and SMART Monitoring). These values are not user-configurable. These items show **N/A** if no SATA device is installed in the system.

**Type [Auto]**

Allows you to select the type of device installed.

- [Not Installed] Select this option if no device is installed.
- [Auto] Allows automatic selection of the appropriate device type.
- [CDROM] Select this option if you are specifically configuring a CD-ROM drive.
- [ARMD] Select [ARMD] (ATAPI Removable Media Device) if your device is either a ZIP, LS-120, or MO drive.

**LBA/Large Mode [Auto]**

- [Auto] Select [Auto] to enable the LBA mode (Logical Block Addressing mode) if the device supports this mode, and if the device was not previously formatted with LBA mode disabled.
- [Disabled] Disables this function.

**Block (Multi-Sector Transfer) M [Auto]**

- [Auto] When set to [Auto], the data transfer from and to the device occurs in multiple sectors at a time if the device supports multi-sector transfer feature.
- [Disabled] When set to [Disabled], the data transfer from and to the device occurs one sector at a time.

**PIO Mode [Auto]**

- [Auto] Allows automatic selection of the PIO (Programmed input/output) modes, which correspond to different data transfer rates.
- [0] [1] [2] [3] [4] Sets the PIO mode to Mode 0, 1, 2, 3, or 4.

**DMA Mode [Auto]**

DMA (Direct Memory Access) allows your computer to transfer data to and from the hardware devices installed with much less CPU overhead.

The DMA mode consists of SDMA (single-word DMA), MDMA (multi-word DMA), and UDMA (Ultra DMA). Setting to [Auto] allows automatic selection of the DMA mode.

**SMART Monitoring [Auto]**

- [Auto] Allows automatic selection of the S.M.A.R.T (Smart Monitoring, Analysis, and Reporting Technology).
- [Enabled] Enables the S.M.A.R.T feature.
- [Disabled] Disables the S.M.A.R.T feature.

**32Bit Data Transfer [Enabled]**

- [Enabled] Sets the controller to combine two 16-bit reads from the hard disk into a single 32-bit double word transfer to the processor. This makes more efficient use of the PCI bus as fewer transactions are needed for the transfer of a particular amount of data.
- [Disabled] Disables this function.

### 3.4.2 Storage Configuration

The Storage Configuration menu allows you to configure your storage devices. Select an item then press <Enter> to display the submenu.

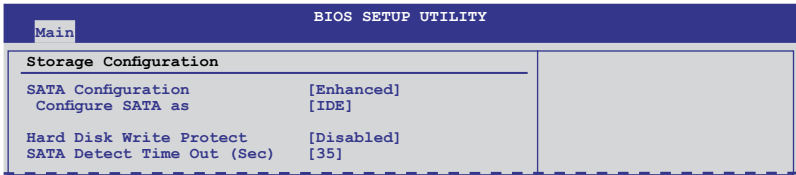

#### SATA Configuration [Enhanced]

Configuration options: [Disabled] [Compatible] [Enhanced]

##### *Configure SATA as [IDE]*

Allows you to set the SATA configuration. This item appears only when you set the **SATA Configuration** item to [Enhanced] or [Compatible].

- [IDE] Set to [IDE] when you want to use the Serial ATA hard disk drives as Parallel ATA physical storage devices.
- [RAID] Set to [RAID] when you want to create a RAID configuration from the SATA hard disk drives.
- [AHCI] Set to [AHCI] when you want the SATA hard disk drives to use the AHCI (Advanced Host Controller Interface). The AHCI allows the onboard storage driver to enable advanced Serial ATA features that increases storage performance on random workloads by allowing the drive to internally optimize the order of commands.

#### Hard Disk Write Protect [Disabled]

[Enabled] Enables device write protection. This function will be effective only if the device is accessed through BIOS.

[Disabled] Disables this function.

#### SATA Detect Time Out (Sec) [35]

Selects the time out value for detecting ATA/ATAPI devices from the following options: [0] [5] [10] [15] [20] [25] [30] [35]

### 3.4.3 AHCI Configuration

This menu is the section for AHCI configuration. It appears only when you set the item **Configure SATA as** from the submenu of **SATA Configuration** to **[AHCI]**.

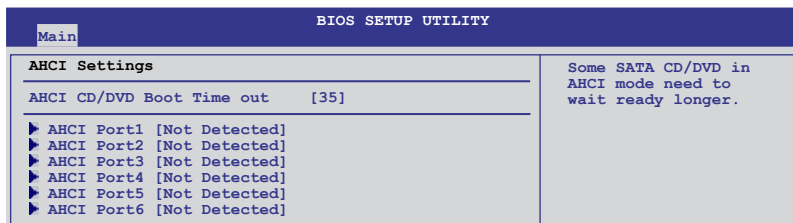

#### AHCI CD/DVD Boot Time out [35]

Selects the boot time out value for SATA CD/DVD devices in AHCI mode from the following options: [0] [5] [10] [15] [20] [25] [30] [35]

#### SATA Port1-6 [XXXX]

Displays the status of auto-detection of SATA devices.

##### SATA Port1-6 [Auto]

[Auto] Allows automatic selection of the device type connected to the system.

[Not Installed] Selects this option if no SATA devices are installed.

##### SMART Monitoring [Enabled]

S.M.A.R.T. (Self-Monitoring, Analysis and Reporting Technology) is a monitor system. When read/write of your hard disk errors occur, this feature allows the hard disk to report warning messages during the POST.

[Enabled] Enables the SMART monitoring feature.

[Disabled] Disables the SMART monitoring feature.

### 3.4.4 System Information

This menu gives you an overview of the general system specifications. The BIOS automatically detects the BIOS information, CPU specification, and system memory in this menu.

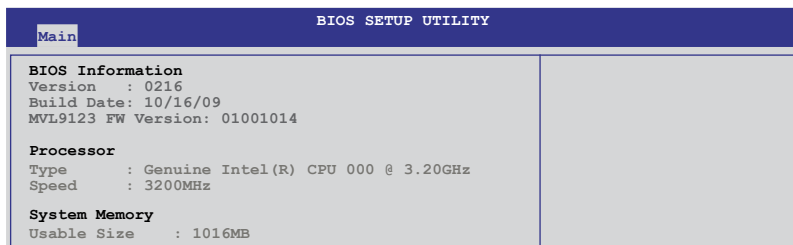

## 3.5 Ai Tweaker menu

The Ai Tweaker menu items allow you to configure overclocking-related items.



Be cautious when changing the settings of the Ai Tweaker menu items. Incorrect field values can cause the system to malfunction.



The configuration options for this chapter vary depending on the CPU and DIMM model you installed on the motherboard.

BIOS SETUP UTILITY  
Main **Ai Tweaker** Advanced Power Boot Tools Exit

Configure System Performance Settings

Ai Overclock Tuner	[Auto]
CPU Ratio Setting	[Auto]
Intel(R) SpeedStep(TM) Tech	[Enabled]
Intel(R) TurboMode Tech	[Enabled]
Xtreme Phase Full Power Mode	[Auto]
DRAM Frequency	[Auto]
UCLK Frequency	[Auto]
QPI Link Data Rate	[Auto]

▶ DRAM Timing Control

\*\*\*\*\* Please key in numbers directly! \*\*\*\*\*

CPU Voltage Control	[Manual]
CPU Voltage	[Auto]
CPU PLL Voltage	[Auto]
QPI/DRAM Core Voltage	[Auto]
IOH Voltage	[Auto]

[D.O.C.P]  
It's designed to  
overclock DRAM  
frequency by adjusting  
BCLK frequency.  
[X.M.P.]  
When X.M.P. is enabled  
BCLK frequency,  
CPU ratio and memory  
parameters will be  
auto optimized.

←→ Select Screen  
↑↓ Select Item  
+- Change Option  
F1 General Help  
F10 Save and Exit  
ESC Exit

v02.61 (C) Copyright 1985-2009, American Megatrends, Inc.

Scroll down to display the following items:

IOH PCIE Voltage	[Auto]
ICH Voltage	[Auto]
ICH PCIE Voltage	[Auto]
DRAM Bus Voltage	[Auto]
DRAM DATA REF Voltage on CHA	[Auto]
DRAM CTRL REF Voltage on CHA	[Auto]
DRAM DATA REF Voltage on CHB	[Auto]
DRAM CTRL REF Voltage on CHB	[Auto]
DRAM DATA REF Voltage on CHC	[Auto]
DRAM CTRL REF Voltage on CHC	[Auto]

\*\*\*\*\*

Load-Line Calibration	[Auto]
CPU Differential Amplitude	[Auto]
CPU Clock Skew	[Auto]
CPU Spread Spectrum	[Auto]
IOH Clock Skew	[Auto]
PCIE Spread Spectrum	[Auto]

←→ Select Screen  
↑↓ Select Item  
+- Change Option  
F1 General Help  
F10 Save and Exit  
ESC Exit

v02.61 (C) Copyright 1985-2009, American Megatrends, Inc.

### 3.5.1 Ai Overclock Tuner [Auto]

Allows you to select the CPU overclocking options to achieve the desired CPU internal frequency. Select any of these preset overclocking configuration options:

<b>Manual</b>	Allows you to individually set overclocking parameters.
<b>Auto</b>	Loads the optimal settings for the system.
<b>D.O.C.P</b>	Overclocks DRAM frequency by adjusting BCLK frequency.
<b>X.M.P.</b>	If you install memory modules supporting the eXtreme Memory Profile (X.M.P.) Technology, choose this item to set the profiles supported by your memory modules for optimizing the system performance.



The configuration options for the following sub-items vary depending on the DIMMs you install on the motherboard.

### **DRAM O.C. Profile [DDR3-1805MHz]**

This item appears only when you set the **Ai Overclock Tuner** item to [D.O.C.P.] and allows you to select a DRAM O.C. profile, which applies different settings to DRAM frequency, DRAM timing and DRAM voltage. Configuration options: [DDR3-1805MHz] [DDR3-2006MHz]

### **eXtreme Memory Profile [Disabled]**

This item appears only when you set the **Ai Overclock Tuner** item to [X.M.P.] and allows you to select the X.M.P. mode supported by your memory module.

- [Disabled] You are not allowed to select the memory profile.
- [High Performance] Allows your memory to work in high performance.
- [High Frequency] Allows your memory to work in high frequency.



To obtain the best performance of the X.M.P. DIMM or 1600MHz DIMM, install only one DIMM on each memory channel.

## **3.5.2 CPU Ratio Setting [Auto]**

Allows you to set the ratio between the CPU Core Clock and the BCLK Frequency. Use <+> and <-> keys to adjust the ratio. The valid value ranges vary according to your CPU model.

### **3.5.3 Intel(R) SpeedStep(TM) Tech [Enabled]**

- [Enabled] The CPU speed is controlled by the operating system.
- [Disabled] The CPU runs at its default speed.

### **3.5.4 Intel(R) TurboMode Tech [Enabled]**

- [Enabled] Allows processor cores to run faster than marked frequency in specific condition.
- [Disabled] Disables this function.

### **3.5.5 Xtreme Phase Full Power Mode [Auto]**

- [Auto] Automatic configuration.
- [Enabled] Enables Full Power Mode to ensure the best CPU overclocking performance.



The following two items appear only when you set the **Ai Overclock Tuner** item to [Manual], [D.O.C.P.] or [X.M.P.].

## **3.5.6 BCLK Frequency [XXX]**

Allows you to adjust the CPU operating frequency to enhance the system performance. Use the <+> and <-> keys to adjust the value. You can also key in the desired value using the numeric keypad. The values range from 100 to 500.

### 3.5.7 PCIE Frequency [XXX]

Allows you to set the PCI Express frequency. Use the <+> and <-> keys to adjust the PCIE frequency. You can also key in the desired value using the numeric keypad. The values range from 100 to 200.

### 3.5.8 DRAM Frequency [Auto]

Allows you to set the DDR3 operating frequency. The configuration options vary with the **BCLK Frequency** item settings.



---

Selecting a very high DRAM frequency may cause the system to become unstable! If this happens, revert to the default setting.

---

### 3.5.9 UCLK Frequency [XXX]

Allows you to set the CPU Uncore frequency to increase the transmission bandwidth between the memory controller and memory modules. The configuration options vary with the **DRAM Frequency** item settings.

### 3.5.10 QPI Link Data Rate [Auto]

Allows you to set the QuickPath Interconnect (QPI) frequency to enhance the system performance. Configuration options: [Auto] [4728MT/s] [5778MT/s] [6304MT/s]

### 3.5.11 DRAM Timing Control [Auto]

The items in this menu allow you to set the DRAM timing control features.



---

The configuration options for some of the following items vary depending on the DIMMs you install on the motherboard.

---

#### 1st Information: 7-7-7-20-4-59-9-6-20-0

The values vary depending on your settings of the following sub-items:

DRAM CAS# Latency [Auto]

Configuration options: [Auto] [3 DRAM Clock] [4 DRAM Clock] – [10 DRAM Clock] [11 DRAM Clock]

DRAM RAS# to CAS# Delay [Auto]

Configuration options: [Auto] [3 DRAM Clock] [4 DRAM Clock] – [9 DRAM Clock] [10 DRAM Clock]

DRAM RAS# PRE Time [Auto]

Configuration options: [Auto] [3 DRAM Clock] [4 DRAM Clock] – [9 DRAM Clock] [10 DRAM Clock]

DRAM RAS# ACT Time [Auto]

Configuration options: [Auto] [3 DRAM Clock] [4 DRAM Clock] – [30 DRAM Clock] [31 DRAM Clock]

DRAM RAS# to RAS# Delay [Auto]

Configuration options: [Auto] [1 DRAM Clock] – [7 DRAM Clock]



DRAM REF Cycle Time [Auto]

Configuration options: [Auto] [30 DRAM Clock] [36 DRAM Clock]  
 [48 DRAM Clock] [60 DRAM Clock] [72 DRAM Clock] [82 DRAM Clock]  
 [88 DRAM Clock] [90 DRAM Clock] [100 DRAM Clock] [110 DRAM Clock]

DRAM WRITE Recovery Time [Auto]

Configuration options: [Auto] [1 DRAM Clock] – [15 DRAM Clock]

DRAM READ to PRE Time [Auto]

Configuration options: [Auto] [3 DRAM Clock] – [15 DRAM Clock]

DRAM FOUR ACT WIN Time [Auto]

Configuration options: [Auto] [1 DRAM Clock] – [63 DRAM Clock]

DRAM Back-To-Back CAS# Delay [Auto]

Configuration options: [Auto] [4 DRAM Clock] – [32 DRAM Clock]

**2nd Information: 1N-61-0-0**

The values vary depending on your settings of the following sub-items:

DRAM Timing Mode [Auto]

Configuration options: [Auto] [1N] [2N] [3N]

DRAM Round Trip Latency on CHA [Auto]

Configuration options: [Auto] [Advance 15 Clock] – [Advance 1 Clock] [Normal]  
 [Delay 1 Clock] – [Delay 15 Clock]

DRAM Round Trip Latency on CHB [Auto]

Configuration options: [Auto] [Advance 15 Clock] – [Advance 1 Clock] [Normal]  
 [Delay 1 Clock] – [Delay 15 Clock]

DRAM Round Trip Latency on CHC [Auto]

Configuration options: [Auto] [Advance 15 Clock] – [Advance 1 Clock] [Normal]  
 [Delay 1 Clock] – [Delay 15 Clock]

**3rd Information: 6-6-14-9-9-9-7-6-4-7-4**

The values vary depending on your settings of the following sub-items:

DRAM WRITE to READ Delay(DD) [Auto]

Configuration options: [Auto] [1 DRAM Clock] – [8 DRAM Clock]

DRAM WRITE to READ Delay(DR) [Auto]

Configuration options: [Auto] [1 DRAM Clock] – [8 DRAM Clock]

DRAM WRITE to READ Delay(SR) [Auto]

Configuration options: [Auto] [10 DRAM Clock] – [22 DRAM Clock]

DRAM READ to WRITE Delay(DD) [Auto]

Configuration options: [Auto] [2 DRAM Clock] – [14 DRAM Clock]

DRAM READ to WRITE Delay(DR) [Auto]

Configuration options: [Auto] [2 DRAM Clock] – [14 DRAM Clock]

DRAM READ to WRITE Delay(SR) [Auto]

Configuration options: [Auto] [2 DRAM Clock] – [14 DRAM Clock]

DRAM READ to READ Delay(DD) [Auto]

Configuration options: [Auto] [2 DRAM Clock] – [9 DRAM Clock]

DRAM READ to READ Delay(DR) [Auto]

Configuration options: [Auto] [2 DRAM Clock] – [9 DRAM Clock]

DRAM READ to READ Delay(SR) [Auto]

Configuration options: [Auto] [4 DRAM Clock] [6 DRAM Clock]

DRAM WRITE to WRITE Delay(DD) [Auto]

Configuration options: [Auto] [2 DRAM Clock] – [9 DRAM Clock]

DRAM WRITE to WRITE Delay(DR) [Auto]

Configuration options: [Auto] [2 DRAM Clock] – [9 DRAM Clock]

DRAM WRITE to WRITE Delay(SR) [Auto]

Configuration options: [Auto] [4 DRAM Clock] [6 DRAM Clock]

### 3.5.12 CPU Voltage Control [Manual]

[Manual] Allows you to set a fixed CPU voltage.

[Offset] Allows you to set the Offset voltage.



---

The following ten (10) items are adjusted by typing the desired values using the numeric keypad and press the <Enter> key. You can also use the <+> and <-> keys to adjust the value. To restore the default setting, type [auto] using the keyboard and press the <Enter> key.

---

### 3.5.13 CPU Voltage [Auto]

Allows you to set the CPU VCore voltage. The values range from 0.85000V to 2.10000V\* with a 0.00625V interval.



- Refer to the CPU documentation before setting the CPU Vcore voltage. Setting a high VCore voltage may damage the CPU permanently, and setting a low VCore voltage may make the system unstable.
  - The value [2.10000V] of the CPU Voltage item is supported only if the **OV\_CPU** jumper is enabled. Otherwise the maximum voltage supported is [1.70000V]. See **CPU / DRAM Bus / QPI DRAM overvoltage setting** on page 2-22 for details.
- 

### 3.5.14 CPU PLL Voltage [Auto]

Allows you to set the CPU PLL voltage. The values range from 1.80V to 2.50V with a 0.02V interval.

### 3.5.15 QPI/DRAM Core Voltage [Auto]

Allows you to set the QPI/DRAM Core voltage. The values range from 1.20000V to 1.90000V\* with a 0.00625V interval.



---

The value [1.90000V] of the **QPI/DRAM Core Voltage** item is supported only if the **OV\_QPI\_DRAM** jumper is enabled. Otherwise the maximum voltage supported is [1.70000V]. See **CPU / DRAM Bus / QPI DRAM overvoltage setting** on page 2-22 for details.

---

### 3.5.16 IOH Voltage [Auto]

Allows you to set the I/O Hub (IOH) voltage. The values range from 1.10V to 1.70V with a 0.02V interval.

### 3.5.17 IOH PCIE Voltage [Auto]

Allows you to set the IOH PCIE voltage. The values range from 1.50V to 2.76V with a 0.02V interval.

### 3.5.18 ICH Voltage [Auto]

Allows you to set the I/O Controller Hub (ICH) voltage. The values range from 1.10V to 1.40V with a 0.10V interval.

### 3.5.19 ICH PCIE Voltage [Auto]

Allows you to set the ICH PCIE voltage. The values range from 1.50V to 1.80V with a 0.10V interval.

### 3.5.20 DRAM Bus Voltage [Auto]

Allows you to set the DRAM voltage. The values range from 1.50V to 2.46V\* with a 0.02V interval.



- The value [2.46V] of the **DRAM Bus Voltage** item is supported only if the **OV\_DRAM\_BUS** jumper is enabled, otherwise the maximum voltage supported is [1.90V]. See **CPU / DRAM Bus / QPI DRAM overvoltage setting** on page 2-22 for details.
- According to Intel CPU spec, DIMMs with voltage requirement over 1.65V may damage the CPU permanently. We recommend you install the DIMMs with the voltage requirement below 1.65V.
- The values of the **CPU Voltage**, **CPU PLL Voltage**, **QPI/DRAM Core Voltage**, **IOH Voltage**, **IOH PCIE Voltage**, **ICH Voltage**, **ICH PCIE Voltage**, and **DRAM Bus Voltage** items are labeled in different color, indicating the risk levels of high voltage settings. Refer to the table below for details.
- The system may need better cooling system to work stably under high voltage settings.

	Blue	Yellow	Purple	Red
<b>CPU Voltage</b>	0.85000V– 1.22500V	1.23125V– 1.29375V	1.30000V– 1.35000V	1.35625V 1.70000V
<b>CPU PLL Voltage</b>	1.80V–1.90V	1.92V–2.00V	2.02V–2.10V	2.12V–2.50V
<b>QPI/DRAM Core Voltage</b>	1.20000V– 1.26875V	1.27500V– 1.32500V	1.33125V– 1.40000V	1.40625V– 1.70000V
<b>IOH Voltage</b>	1.10V–1.18V	1.20V–1.24V	1.26V–1.30V	1.32V–1.70V
<b>IOH PCIE Voltage</b>	1.50V–1.58V	1.60V–1.66V	1.68V–1.74V	1.76V–2.76V
<b>ICH Voltage</b>	1.10V–1.20V	1.30V–1.40V	N/A	N/A
<b>ICH PCIE Voltage</b>	1.50V–1.60V	1.70V–1.80V	N/A	N/A
<b>DRAM Bus Voltage</b>	1.50V–1.64V	N/A	N/A	1.66V–2.46V

### 3.5.21 DRAM DATA REF Voltage on CHA/B/C [Auto]

Allows you to set the DRAM DATA Reference Voltage on Channel A/B/C. The values range from 0.395x to 0.630x with a 0.005x interval. Different ratio might enhance DRAM overclocking ability.

### 3.5.22 DRAM CTRL REF Voltage on CHA/B/C [Auto]

Allows you to set the DRAM Control Reference Voltage on Channel A/B/C. The values range from 0.395x to 0.630x with a 0.005x interval. Different ratio might enhance DRAM overclocking ability.

### 3.5.23 Load-Line Calibration [Auto]

[Auto] BIOS automatically adjusts the voltage.

[Disabled] Follows the Intel specifications.

[Enabled] Improves the CPU VDrop directly.

### 3.5.24 CPU Differential Amplitude [Auto]

Different AMP might enhance BCLK overclocking ability.

Configuration options: [Auto] [700mV] [800mV] [900mV] [1000mV]

### 3.5.25 CPU Clock Skew [Auto]

Adjusting this item may help enhancing BCLK overclocking ability. You may need to adjust the **IOH Clock Skew** item at the same time.

Configuration options: [Auto] [Normal] [Delay 100ps] [Delay 200ps] – [Delay 1400ps] [Delay 1500ps]

### 3.5.26 CPU Spread Spectrum [Auto]

Set to [Disabled] to enhance BCLK overclocking ability or [Auto] for EMI control.

Configuration options: [Auto] [Disabled] [Enabled]

### 3.5.27 IOH Clock Skew [Auto]

Adjusting this item may help enhancing BCLK overclocking ability. You may need to adjust the **CPU Clock Skew** item at the same time.

Configuration options: [Auto] [Normal] [Delay 100ps] [Delay 200ps] – [Delay 1400ps] [Delay 1500ps]

### 3.5.28 PCIE Spread Spectrum [Auto]

Set to [Disabled] to enhance PCIE overclocking ability or [Auto] for EMI control.

Configuration options: [Auto] [Disabled] [Enabled]

## 3.6 Advanced menu

The Advanced menu items allow you to change the settings for the CPU and other system devices.



Be cautious when changing the settings of the Advanced menu items. Incorrect field values can cause the system to malfunction.

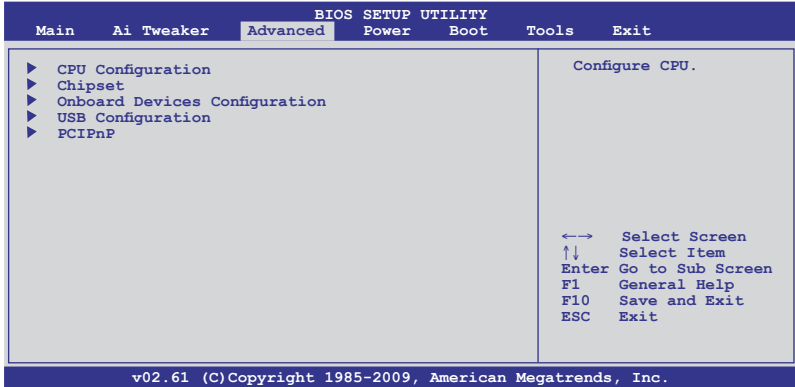

### 3.6.1 CPU Configuration

The items in this menu show the CPU-related information that the BIOS automatically detects.



The items shown in this screen may be different due to the CPU you installed.

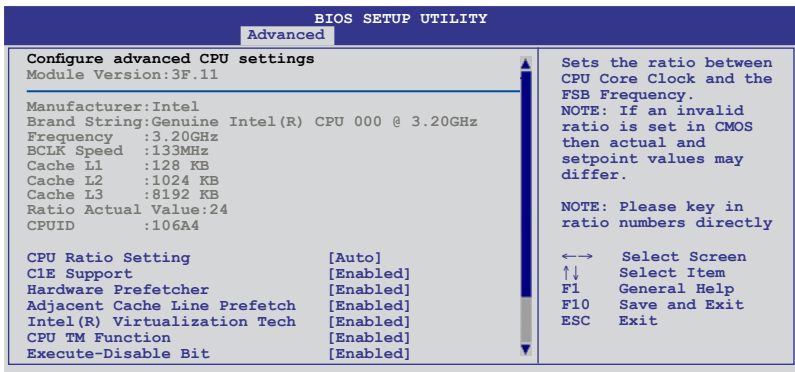

Scroll down to display the following items:

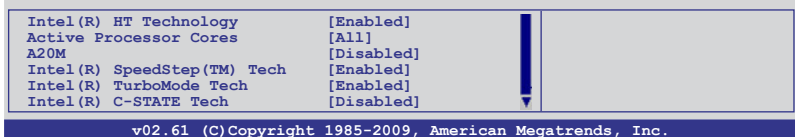

### **CPU Ratio Setting [Auto]**

Allows you to set the ratio between the CPU Core Clock and the BCLK Frequency. Use <+> and <-> keys to adjust the ratio. The valid value ranges vary according to your CPU model.

### **C1E Support [Enabled]**

[Enabled] Enables the C1E support function. This item should be enabled in order to enable the Enhanced Halt State.

[Disabled] Disables this function.

### **Hardware Prefetcher [Enabled]**

[Enabled] The processor fetches data and instructions from the memory into the cache that are likely to be required in the near future. This reduces the latency associated with memory reads.

[Disabled] Disables this function.

### **Adjacent Cache Line Prefetch [Enabled]**

[Enabled] The processor fetches the currently requested cache line, as well as the subsequent cache line. This reduces the cache latency by making the next cache line immediately available if the processor requires it as well.

[Disabled] The processor fetches only the currently requested cache line.

### **Intel(R) Virtualization Tech [Enabled]**

[Enabled] Allows a hardware platform to run multiple operating systems separately and simultaneously, enabling one system to virtually function as several systems.

[Disabled] Disables this function.

### **CPU TM function [Enabled]**

[Enabled] Enables the overheated CPU to throttle its clock speed to cool down.

[Disabled] Disables this function.

### **Execute Disable Bit [Enabled]**

[Enabled] Enables the No-Execution Page Protection Technology.

[Disabled] Forces the XD feature flag to always return to zero (0).

### **Intel(R) HT Technology [Enabled]**

The Intel Hyper-Threading Technology allows a hyper-threading processor to appear as two logical processors to the operating system, allowing the operating system to schedule two threads or processes simultaneously.

[Enabled] Two threads per activated core are enabled.

[Disabled] Only one thread per activated core is enabled.

### **Active Processor Cores [All]**

Allows you to choose the number of CPU cores to activate in each processor package.

Configuration options: [All] [1] [2]

**A20M [Disabled]**

[Enabled] Allows Legacy OSES to be compatible with APs.

[Disabled] Disables this function.

**Intel(R) SpeedStep(TM) Tech [Enabled]**

[Enabled] The CPU speed is controlled by the operating system.

[Disabled] The CPU runs at its default speed.

**Intel(R) TurboMode Tech [Enabled]**

[Enabled] Allows processor cores to run faster than marked frequency in specific condition.

[Disabled] Disables this function.

**Intel(R) C-STATE Tech [Disabled]**

The Intel® C-State Technology allows the CPU to save more power under idle mode.

[Enabled] Enable this item only when you install a C-State Technology-supported CPU.

[Disabled] Disables this function.

**C State package limit setting [Auto]**

This item appears only when you set the **Intel(R) C-STATE Tech** item to [Enabled]. We recommend that you set this item to [Auto] for BIOS to automatically detect the C-State mode supported by your CPU. Configuration options: [Auto] [C1] [C3] [C6] [C7]

### 3.6.2 Chipset

The Chipset menu allows you to change the advanced chipset settings. Select an item and press <Enter> to display the submenu.

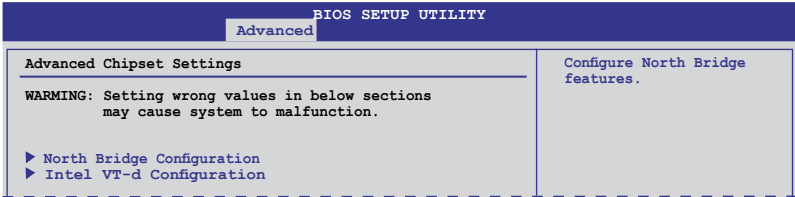

#### North Bridge Chipset Configuration

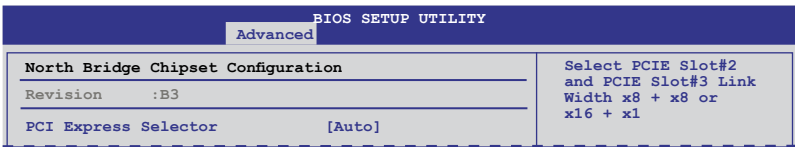

##### PCI Express Selector [Auto]

Allows you to decide the Link Width of the PCIe x16\_2 slot and PCIe x16\_3 slot. Configuration options: [Auto] [x8 x8 Mode] [x16 x1 Mode]

#### Intel VT-d Configuration

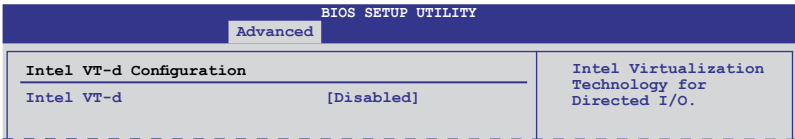

##### Intel VT-d [Disabled]

Allows you to enable or disable the Intel Virtualization Technology for Directed I/O. Configuration options: [Disabled] [Enabled]

### 3.6.3 Onboard Devices Configuration

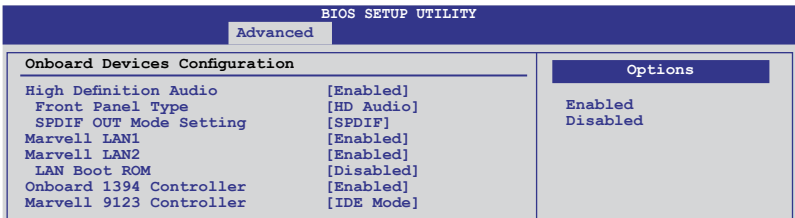



**High Definition Audio [Enabled]**

[Enabled] Enables the High Definition Audio Controller.

[Disabled] Disables the controller.



---

The following item appears only when you set the **High Definition Audio** item to [Enabled].

---

***Front Panel Type [HD Audio]***

Allows you to set the front panel audio connector (AAFP) mode to legacy AC'97 or high-definition audio depending on the audio standard that the front panel audio module supports.

[AC97] Sets the front panel audio connector (AAFP) mode to legacy AC'97

[HD Audio] Sets the front panel audio connector (AAFP) mode to high definition audio.

***SPDIF\_OUT Mode Setting [SPDIF Output]***

If your graphics card has HDMI output and needs to use SPDIF signal from the SPDIF\_Out header, you need to set to HDMI Output for HDMI audio output.

[SPDIF Output] Sets to [SPDIF Output] for SPDIF audio output.

[HDMI Output] Sets to [HDMI Output] for HDMI audio output.

**Marvell LAN1/LAN2 [Enabled]**

[Enabled] Enables the Marvell LAN1/LAN2 controller.

[Disabled] Disables the controller.

***LAN Boot ROM [Disabled]***

This item appears only when you set the previous item to [Enabled].

[Enabled] Enables the Atheros Gigabit LAN Boot ROM.

[Disabled] Disables the LAN Boot ROM.

**Onboard 1394 Controller [Enabled]**

[Enabled] Enables the onboard IEEE 1394a controller.

[Disabled] Disables the controller.

**Marvell 9123 Controller [IDE Mode]**

Allows you to select the Marvell 9123 controller operating mode.

[Disabled] Disables the controller.

[IDE Mode] Set to [IDE Mode] when you want to use the Serial ATA hard disk drives as Parallel ATA physical storage devices.

[AHCI Mode] Set to [AHCI Mode] when you want the SATA hard disk drives to use the AHCI (Advanced Host Controller Interface). The AHCI allows the onboard storage driver to enable advanced Serial ATA features that increases storage performance on random workloads by allowing the drive to internally optimize the order of commands..

### 3.6.4 USB Configuration

The items in this menu allow you to change the USB-related features. Select an item and press <Enter> to display the configuration options.

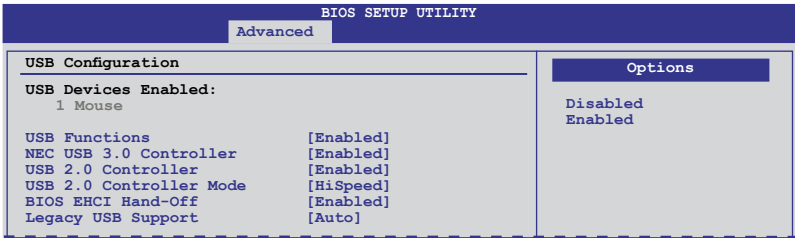

The **USB Devices Enabled** item shows the auto-detected values. If no USB device is detected, the item shows **None**.

#### USB Functions [Enabled]

[Enabled] Enables the USB Host Controllers.

[Disabled] Disables the controllers.



The following two items appear only when you set **USB Functions** to [Enabled].

#### NEC USB 3.0 Controller [Enabled]

[Enabled] Enables the USB 3.0 controller.

[Disabled] Disables the controller.

#### USB 2.0 Controller [Enabled]

[Enabled] Enables the USB 2.0 controller.

[Disabled] Disables the controller.

#### USB 2.0 Controller Mode [HiSpeed]

[FullSpeed] Sets the USB 2.0 controller mode to FullSpeed (12 Mbps).

[HiSpeed] Sets the USB 2.0 controller mode to HiSpeed (480 Mbps).

#### BIOS EHCI Hand-off [Enabled]

[Enabled] Enables the support for operating systems without an EHCI hand-off feature.

[Disabled] Disables the function.



The following item appears only when you set **USB Functions** to [Enabled].

### Legacy USB Support [Auto]

- [Auto] Allows the system to detect the presence of USB devices at startup. If detected, the USB controller legacy mode is enabled. If no USB device is detected, the legacy USB support is disabled.
- [Enabled] Enables the support for USB devices on legacy operating systems (OS).
- [Disabled] Disables the function.

### 3.6.5 PCIPnP

The PCI PnP menu items allow you to change the advanced settings for PCI/PnP devices.

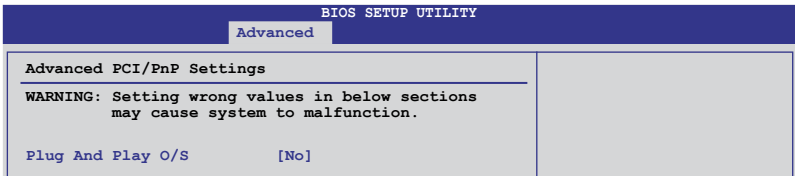

### Plug And Play O/S [No]

- [Yes] When set to [Yes] and if you install a Plug and Play operating system, the operating system configures the Plug and Play devices not required for boot.
- [No] When set to [No], BIOS configures all the devices in the system.

## 3.7 Power menu

The Power menu items allow you to change the settings for the Advanced Power Management (APM). Select an item then press <Enter> to display the configuration options.

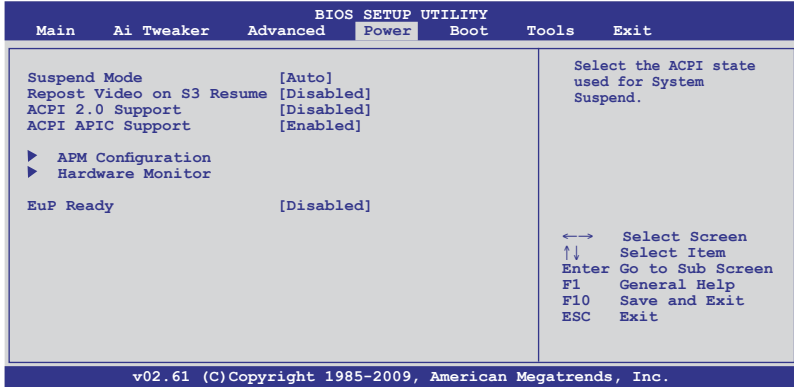

### 3.7.1 Suspend Mode [Auto]

Allows you to select the Advanced Configuration and Power Interface (ACPI) state to be used for system suspend.

[Auto] The system automatically configures the ACPI suspend mode.

[S1 (POS) only] Sets the ACPI suspend mode to S1/POS (Power On Suspend).

[S3 only] Sets the ACPI suspend mode to S3/STR (Suspend To RAM).

### 3.7.2 Repost Video on S3 Resume [No]

Determines whether to invoke VGA BIOS POST on S3/STR resume.

[No] The system will not invoke VGA BIOS POST on S3/STR resume.

[Yes] The system invokes VGA BIOS POST on S3/STR resume.

### 3.7.3 ACPI 2.0 Support [Disabled]

[Disabled] The system will not add additional tables as per ACPI 2.0 specifications.

[Enabled] The system adds additional tables as per ACPI 2.0 specifications.

### 3.7.4 ACPI APIC Support [Enabled]

[Disabled] The system disables the Advanced Configuration and Power Interface (ACPI) support in the Advanced Programmable Interrupt Controller (APIC).

[Enabled] The ACPI APIC table pointer is included in the RSDT pointer list.

### 3.7.5 EuP Ready [Disabled]

[Disabled] Disables the Energy Using Products (EuP) Ready function.

[Enabled] Allows BIOS to switch off some power at S5 state to get system ready for the EuP requirement. When set to [Enabled], power for WOL, WO\_USB, audio and onboard LEDs will be switched off at S5 state.

## 3.7.6 APM Configuration

BIOS SETUP UTILITY	
Power	
<b>APM Configuration</b>	
Restore on AC Power Loss	[Power Off]
Power On By RTC Alarm	[Disabled]
Power On By PCI Devices	[Disabled]
Power On By PCIE Devices	[Disabled]
Power On By PS/2 Keyboard	[Disabled]
Power On By PS/2 Mouse	[Disabled]
<b>Options</b>	
Power Off	
Power On	
Last State	

### Restore On AC Power Loss [Power Off]

- [Power On] The system goes into on state after an AC power loss.
- [Power Off] The system goes into off state after an AC power loss.
- [Last State] The system goes into either off or on state, whatever the system state was before the AC power loss.

### Power On By RTC Alarm [Disabled]

- [Disabled] Disables RTC to generate a wake event.
- [Enabled] When set to [Enabled], the items **RTC Alarm Date (Days)** and **System Time** will become user-configurable with set values.

### Power On By External Modems [Disabled]

- [Disabled] Disables to power up the computer when the external modem receives a call while the computer is in Soft-off mode.
- [Enabled] The computer could be powered up when the external modem receives a call while the computer is in Soft-off mode.



The computer cannot receive or transmit data until the computer and applications are fully running. Thus, connection cannot be made on the first try. Turning an external modem off and then back on while the computer is off causes an initialization string that turns the system power on.

### Power On By PCI Devices [Disabled]

- [Disabled] Disables the PME to wake up from S5 by PCI devices.
- [Enabled] Allows you to turn on the system through a PCI LAN or modem card. This feature requires an ATX power supply that provides at least 1A on the +5VSB lead.

### Power On By PCIE Devices [Disabled]

- [Disabled] Disables the PCIE devices to generate a wake event.
- [Enabled] Enables the PCIE devices to generate a wake event.

### Power On By PS/2 Keyboard [Disabled]

- [Disabled] Disables the Power On by a PS/2 keyboard.
- [Enabled] Sets specific keys on the PS/2 keyboard to turn on the system. This feature requires an ATX power supply that provides at least 1A on the +5VSB lead.

### Power On By PS/2 Mouse [Disabled]

- [Disabled] Disables the Power On by a PS/2 mouse.
- [Enabled] Enables the Power On by a PS/2 mouse. This feature requires an ATX power supply that provides at least 1A on the +5VSB lead.

### 3.7.7 Hardware Monitor

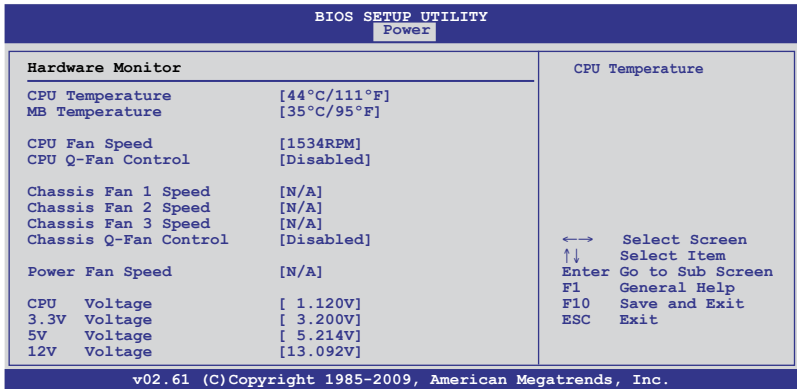

#### CPU/MB Temperature [xxx°C/xxx°F]

The onboard hardware monitor automatically detects and displays the CPU and motherboard temperatures. Select **Ignored** if you do not wish to display the detected temperatures.

#### CPU Fan Speed [xxxxRPM] or [Ignored] / [N/A]

#### Chassis Fan 1/2/3 Speed [xxxxRPM] or [Ignored] / [N/A]

#### Power Fan Speed [xxxxRPM] or [Ignored] / [N/A]

The onboard hardware monitor automatically detects and displays the CPU, chassis, and power fan speed in rotations per minute (RPM). If the fan is not connected to the motherboard, the field shows **N/A**. Select **Ignored** if you do not wish to display the detected speed.

#### CPU Q-Fan Control [Disabled]

[Disabled] Disables the CPU Q-Fan control feature.

[Enabled] Enables the CPU Q-Fan control feature.

##### *CPU Fan Profile [Standard]*

This item appears only when you enable the **CPU Q-Fan Control** feature and allows you to set the appropriate performance level of the CPU fan.

[Standard] Sets to [Standard] to make the CPU fan automatically adjust depending on the CPU temperature.

[Silent] Sets to [Silent] to minimize the fan speed for quiet CPU fan operation.

[Turbo] Sets to [Turbo] to achieve maximum CPU fan speed.

#### Chassis Q-Fan Control [Disabled]

[Disabled] Disables the Chassis Q-Fan control feature.

[Enabled] Enables the Chassis Q-Fan control feature.

### Chassis Fan Profile [Standard]

This item appears only when you enable the **Chassis Q-Fan Control** feature and allows you to set the appropriate performance level of the chassis fan.

[Standard] Sets to [Standard] to make the chassis fan automatically adjust depending on the chassis temperature.

[Silent] Sets to [Silent] to minimize the fan speed for quiet chassis fan operation.

[Turbo] Sets to [Turbo] to achieve maximum chassis fan speed.

## CPU Voltage, 3.3V Voltage, 5V Voltage, 12V Voltage

The onboard hardware monitor automatically detects the voltage output through the onboard voltage regulators. Select **Ignored** if you do not want to detect this item.

## 3.8 Boot menu

The Boot menu items allow you to change the system boot options. Select an item then press <Enter> to display the submenu.

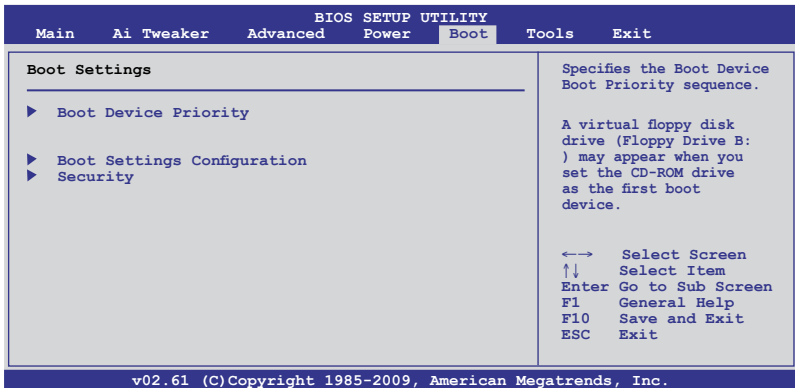

### 3.8.1 Boot Device Priority

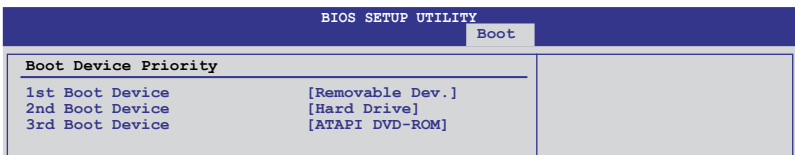

#### 1st – xxth Boot Device [Removable Dev.]

These items specify the boot device priority sequence from the available devices. The number of device items that appears on the screen depends on the number of devices installed in the system.

Configuration options: [Removable Dev.] [Hard Drive] [ATAPI CD-ROM] [Disabled]

## 3.8.2 Boot Settings Configuration

BIOS SETUP UTILITY	
Boot	
<b>Boot Settings Configuration</b>	
Quick Boot	[Enabled]
Full Screen Logo	[Enabled]
AddOn ROM Display Mode	[Force BIOS]
Bootup Num-Lock	[On]
Wait For 'F1' If Error	[Enabled]
Hit 'DEL' Message Display	[Enabled]
Allows BIOS to skip certain tests while booting. This will decrease the time needed to boot the system.	

### Quick Boot [Enabled]

- [Disabled] When set to [Disabled], BIOS performs all the POST items.
- [Enabled] When set to [Enabled], BIOS skips some power on self tests (POST) while booting to decrease the time needed to boot the system.

### Full Screen Logo [Enabled]

- [Enabled] Enables the full screen logo display feature.
- [Disabled] Disables the full screen logo display feature.



Set this item to [Enabled] to use the ASUS MyLogo 2™ feature.

### AddOn ROM Display Mode [Force BIOS]

- [Force BIOS] The third-party ROM messages will be forced to display during the boot sequence.
- [Keep Current] The third-party ROM messages will be displayed only if the third-party manufacturer had set the add-on device to do so.

### Bootup Num-Lock [On]

- [Off] Sets the power-on state of the NumLock to [Off].
- [On] Sets the power-on state of the NumLock to [On].

### Wait For 'F1' If Error [Enabled]

- [Disabled] Disables this function.
- [Enabled] The system waits for the <F1> key to be pressed when error occurs.

### Hit 'DEL' Message Display [Enabled]

- [Disabled] Disables this function.
- [Enabled] The system displays the message "Press DEL to run Setup" during POST.



### 3.8.3 Security

The Security menu items allow you to change the system security settings. Select an item and press <Enter> to display the configuration options.

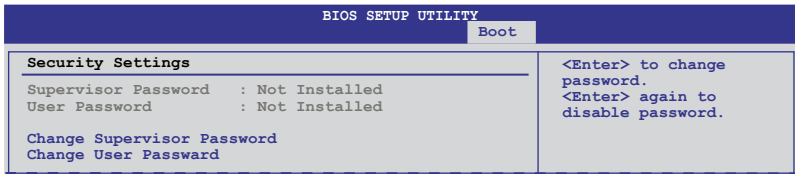

#### Change Supervisor Password

Select this item to set or change the supervisor password. The **Supervisor Password** item on top of the screen shows the default **Not Installed**. After you set a password, this item shows **Installed**.

To set a Supervisor Password:

1. Select the **Change Supervisor Password** item and press <Enter>.
2. From the password box, key in a password composed of at least six letters and/or numbers, then press <Enter>.
3. Confirm the password when prompted.

The message **Password Installed** appears after you successfully set your password.

To change the supervisor password, follow the same steps as in setting a user password.

To clear the supervisor password, select the **Change Supervisor Password** then press <Enter>. The message **Password Uninstalled** appears.



If you have forgotten your BIOS password, you can clear it by erasing the CMOS Real Time Clock (RTC) RAM. See section 2.6 **Jumpers** for information on how to erase the RTC RAM.

After you have set a supervisor password, the other items appear to allow you to change other security settings.

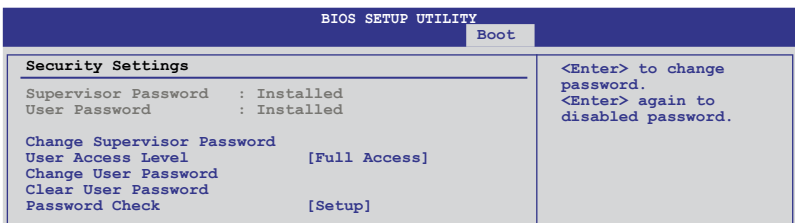

#### User Access Level [Full Access]

This item allows you to select the access restriction to the Setup items.

- [No Access] Prevents user access to the Setup utility.
- [View Only] Allows access but does not allow change to any field.
- [Limited] Allows changes only to selected fields, such as Date and Time.
- [Full Access] Allows viewing and changing all the fields in the Setup utility.

## Change User Password

Select this item to set or change the user password. The **User Password** item on top of the screen shows the default **Not Installed**. After you set a password, this item shows Installed.

To set a User Password:

1. Select the **Change User Password** item and press <Enter>.
2. On the password box that appears, type a password composed of at least six letters and/or numbers, then press <Enter>.
3. Confirm the password when prompted.

The message **Password Installed** appears after you set your password successfully.

To change the user password, follow the same steps as in setting a user password.

## Clear User Password

Select this item to clear the user password.

## Password Check [Setup]

- |          |   |
|----------|---|
| [Setup]  | BIOS checks for user password when accessing the Setup utility.                 |
| [Always] | BIOS checks for user password both when accessing Setup and booting the system. |

## 3.9 Tools menu

The Tools menu items allow you to configure options for special functions. Select an item then press <Enter> to display the submenu.

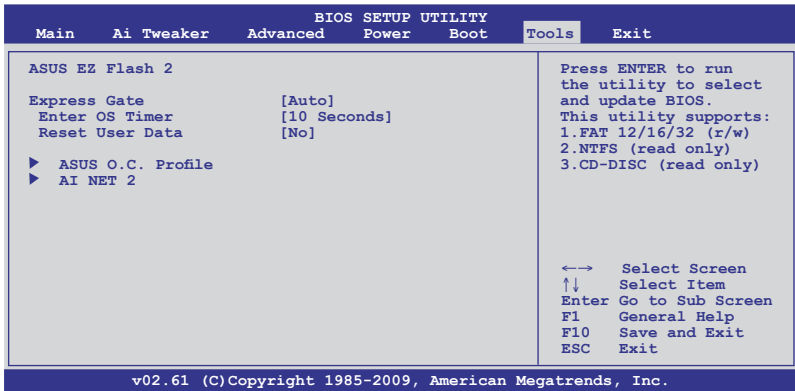

### 3.9.1 ASUS EZ Flash 2

Allows you to run ASUS EZ Flash 2. When you press <Enter>, a confirmation message appears. Use the left/right arrow key to select between [Yes] or [No], then press <Enter> to confirm your choice.



For more details, refer to **section 3.2.2 ASUS EZ Flash 2 utility**.

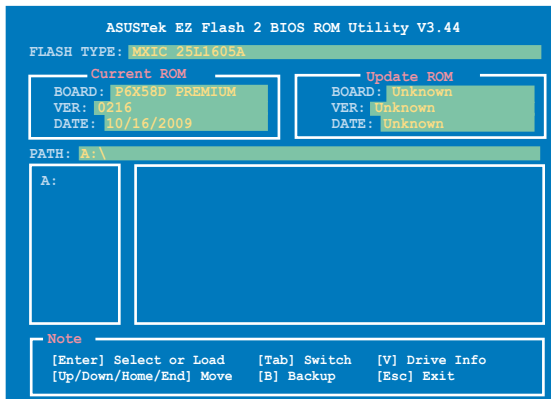

### 3.9.2 Express Gate [Auto]

Allows you to enable or disable the ASUS Express Gate feature. The ASUS Express Gate feature is a unique instant-on environment that provides quick access to the Internet browser and Skype. Configuration options: [Enabled] [Disabled] [Auto]

#### Enter OS Timer [10 Seconds]

Sets countdown duration that the system waits at the Express Gate's first screen before starting Windows or other installed OS. Choose [Prompt User] to stay at the first screen of Express Gate for user action.

Configuration options: [Prompt User] [1 second] [3 seconds] [5 seconds] [10 seconds] [15 seconds] [20 seconds] [30 seconds]

#### Reset User Data [No]

Allows you to clear Express Gate's user data.

[Reset] When setting this item to [Reset], ensure that you save the setting to the BIOS so that the user data will be cleared the next time you enter the Express Gate. User data includes the Express Gate's settings as well as any personal information stored by the web browser such as bookmarks, cookies, browsing history. This is useful in the rare case where corrupt settings prevent the Express Gate environment from launching properly.

[No] Sets to [No] to disable the **Reset User Data** function when entering the Express Gate.



---

The first time wizard will run again when you enter the Express Gate environment after clearing its settings.

---

### 3.9.3 ASUS O.C. Profile

This item allows you to store or load multiple BIOS settings.

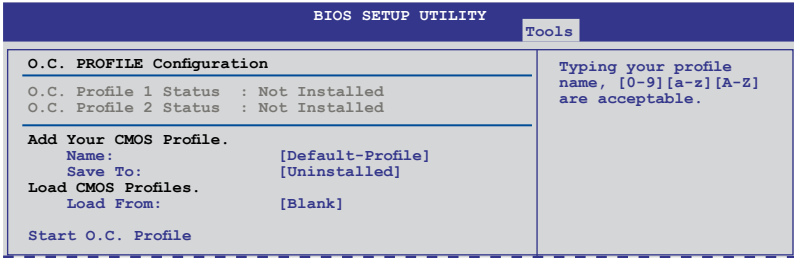

#### Add Your CMOS Profile

Allows you to save the current BIOS file to the BIOS Flash. In the Name sub-item, key in your profile name and press <Enter>, and then choose a profile number to save your CMOS settings in the **Save to** sub-item.

#### Load CMOS Profiles.

Allows you to load the previous BIOS settings saved in the BIOS Flash. Press <Enter> to load the file.

#### Start O.C. Profile

Allows you to run the utility to save and load CMOS. Press <Enter> to run the utility.

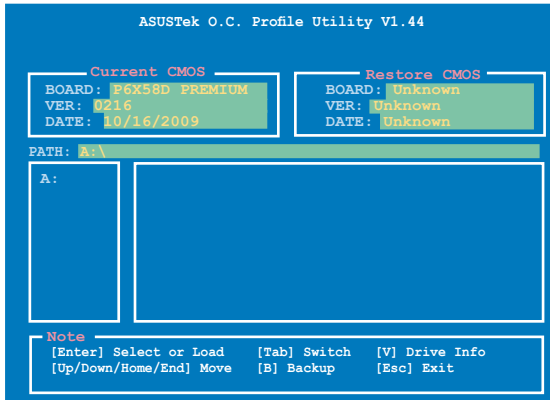

- This function can support devices such as a USB flash disk with FAT 32/16 format and single partition only.
- DO NOT shut down or reset the system while updating the BIOS to prevent the system boot failure!
- We recommend that you update the BIOS file only coming from the same memory/CPU configuration and BIOS version.
- Only the CMO file can be loaded.

### 3.9.4 AI NET 2

BIOS SETUP UTILITY			Tools
AI NET 2			Check Marvell LAN cable during POST.
Pair	Status	Length	
Check Marvell LAN cable [Disabled]			

#### Check Marvell LAN cable [Disabled]

- [Disabled] BIOS will not check the Marvell LAN cable during the Power-On Self-Test (POST).
- [Enabled] BIOS checks the Marvell LAN cable during the Power-On Self-Test (POST).

## 3.10 Exit menu

The Exit menu items allow you to load the optimal or failsafe default values for the BIOS items, and save or discard your changes to the BIOS items.

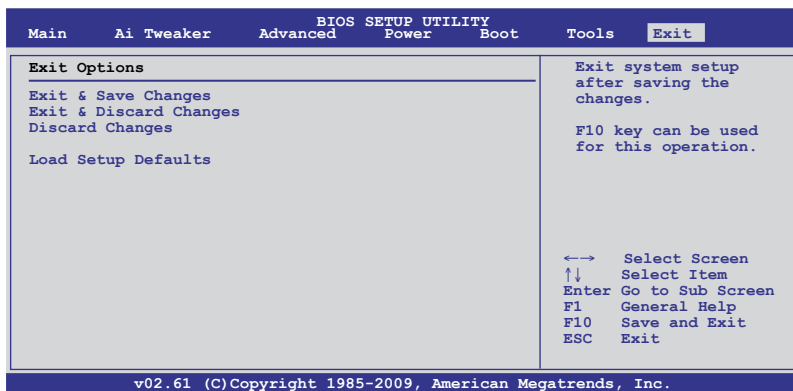

Pressing <Esc> does not immediately exit this menu. Select one of the options from this menu or <F10> from the legend bar to exit.

### Exit & Save Changes

Once you are finished making your selections, choose this option from the Exit menu to ensure the values you selected are saved to the CMOS RAM. An onboard backup battery sustains the CMOS RAM so it stays on even when the PC is turned off. When you select this option, a confirmation window appears. Select **Ok** to save changes and exit.



If you attempt to exit the Setup program without saving your changes, the program prompts you with a message asking if you want to save your changes before exiting. Press <Enter> to save the changes while exiting.

### Exit & Discard Changes

Select this option only if you do not want to save the changes that you made to the Setup program. If you made changes to fields other than System Date, System Time, and Password, the BIOS asks for a confirmation before exiting.

### Discard Changes

This option allows you to discard the selections you made and restore the previously saved values. After selecting this option, a confirmation appears. Select **Ok** to discard any changes and load the previously saved values.

### Load Setup Defaults

This option allows you to load the default values for each of the parameters on the Setup menus. When you select this option or if you press <F5>, a confirmation window appears. Select **Ok** to load default values. Select **Exit & Save Changes** or make other changes before saving the values to the non-volatile RAM.





# Chapter 4

## 4.1 Installing an operating system

This motherboard supports Windows® XP/ 64-bit XP/ Vista / 64-bit Vista / 7 / 64-bit 7 operating systems (OS). Always install the latest OS version and corresponding updates to maximize the features of your hardware.



- Motherboard settings and hardware options vary. Use the setup procedures presented in this chapter for reference only. Refer to your OS documentation for detailed information.
- Ensure that you install the Windows® XP Service Pack 2 or later versions before installing the drivers for better compatibility and system stability.

## 4.2 Support DVD information

The support DVD that comes with the motherboard package contains the drivers, software applications, and utilities that you can install to avail all motherboard features.



The contents of the support DVD are subject to change at any time without notice. Visit the ASUS website at [www.asus.com](http://www.asus.com) for updates.

### 4.2.1 Running the support DVD

Place the support DVD into the optical drive. The DVD automatically displays the Drivers menu if Autorun is enabled in your computer. Click each menu tab and select the items you want to install.

The Drivers menu shows the available device drivers if the system detects installed devices. Install the necessary drivers to use the devices.

The Make Disk menu contains items to create the RAID/AHCI driver disk.

The Manual menu contains the list of supplementary user manuals. Click an item to open the folder of the user manual.

The Utilities menu shows the applications and other software that the motherboard supports.

Click an item to install

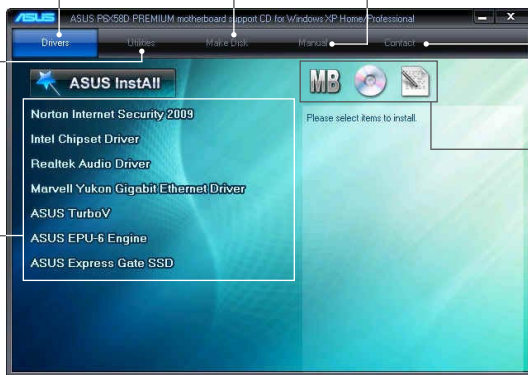

Click the Contact tab to display the ASUS contact information.

Click an icon to display DVD/motherboard information



If Autorun is NOT enabled in your computer, browse the contents of the support DVD to locate the file ASSETUP.EXE from the BIN folder. Double-click the ASSETUP.EXE to run the DVD.

## 4.2.2 Obtaining the software manuals

The software manuals are included in the support DVD. Follow the instructions below to get the necessary software manuals.



The software manual files are in Portable Document Format (PDF). Install the Adobe® Acrobat® Reader from the Utilities menu before opening the files.

1. Click the **Manual** tab. Click **ASUS Motherboard Utility Guide** from the manual list on the left.

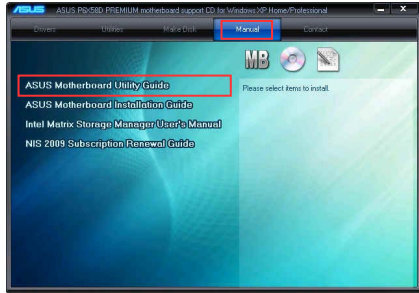

2. The **Manual** folder of the support DVD appears. Double-click the folder of your selected software.

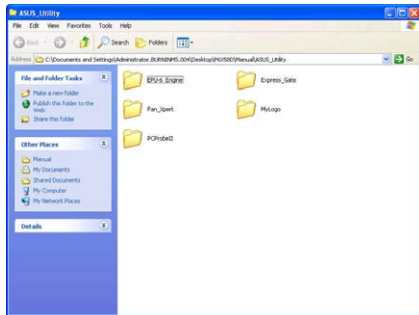

3. Some software manuals are provided in different languages. Double-click the language to show the software manual.

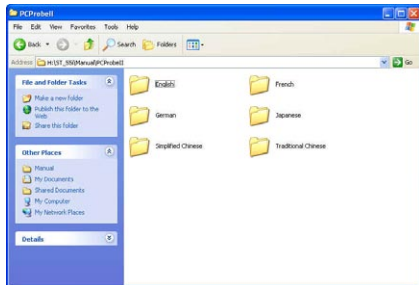

The screenshots in this section are for reference only. The actual software manuals containing in the support DVD vary by models.

## 4.3 Software information

Most of the applications in the support DVD have wizards that will conveniently guide you through the installation. View the online help or readme file that came with the software application for more information.

### 4.3.1 ASUS PC Probe II

PC Probe II is a utility that monitors the computer's vital components, and detects and alerts you of any problem with these components. PC Probe II senses fan rotations, CPU temperature, and system voltages, among others. Because PC Probe II is software-based, you can start monitoring your computer the moment you turn it on. With this utility, you are assured that your computer is always at a healthy operating condition.

#### Launching PC Probe II

1. Install PC Probe II from the motherboard support DVD.
2. Launch PC Probe II by clicking **Start > All Programs > ASUS > PC Probe II > PC Probe II v1.xx.xx**. The PC Probe II main window appears.
3. The PC Probe II icon appears in the Windows® notification area. Click this icon to close or restore the application.

#### PC Probe II main window

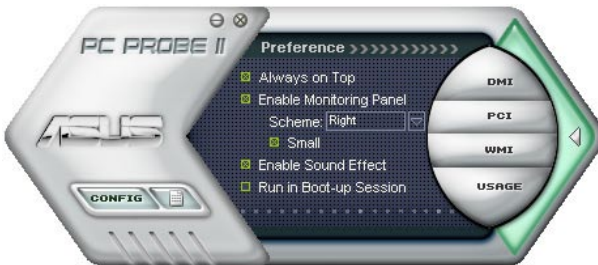

Button	Function
	Opens the Configuration window
	Opens the Report window
	Opens the Desktop Management Interface window
	Opens the Peripheral Component Interconnect window
	Opens the Windows Management Instrumentation window
	Opens the hard disk drive, memory, CPU usage window
	Shows/Hides the Preference section
	Minimizes the application
	Closes the application



Refer to the software manual in the support DVD or visit the ASUS website at [www.asus.com](http://www.asus.com) for detailed software configuration.

### 4.3.2 ASUS AI Suite

ASUS AI Suite allows you to launch several ASUS utilities easily.

#### Launching AI Suite

1. Install AI Suite from the motherboard support DVD.
2. Launch AI Suite by clicking **Start > All Programs > ASUS > AI Suite > AI Suite v1.xx**. The AI Suite main window appears.
3. The AI Suite icon  appears in the Windows® notification area. If you minimize the application main window, click this icon to restore the window.

#### Using AI Suite

Click each utility button to launch the utility, or click the **Normal** button to restore system default settings.

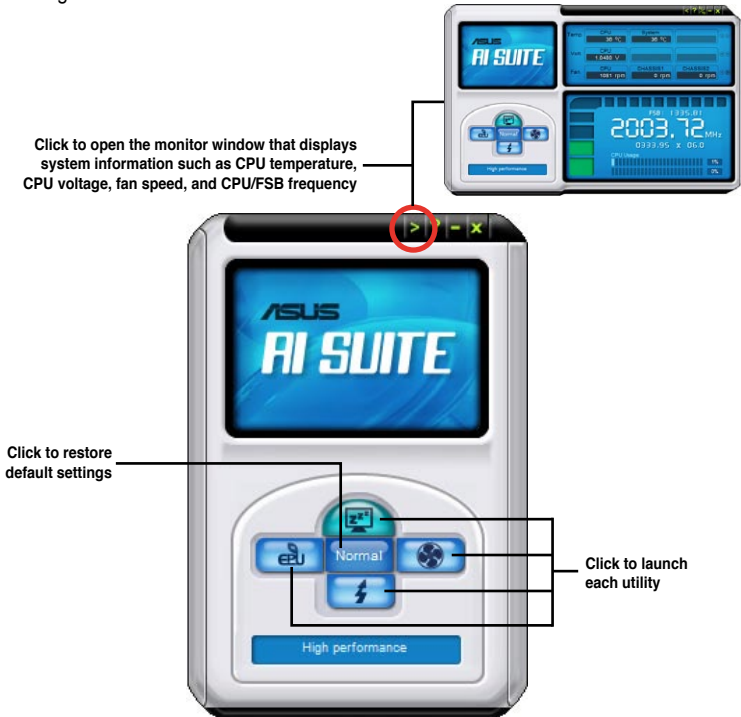





- The screenshots in this section are for reference only. The actual utility buttons vary by models.
- Refer to the software manual in the support DVD or visit the ASUS website at [www.asus.com](http://www.asus.com) for detailed software configuration.

### 4.3.3 ASUS EPU

ASUS EPU is an energy-efficient tool that provides you with a total system power-saving solution. It detects the current computer loading and intelligently adjusts the power in real-time. With auto phase switching for components, the EPU automatically provides the most appropriate power usage via intelligent acceleration and overlocking.

ASUS EPU provides you with these modes to choose from:

-  **Turbo Mode**
-  **High Performance Mode**
-  **Medium Power Saving Mode**
-  **Max. Power Saving Mode**

When you select Auto Mode , the system shifts modes automatically according to the current system status. You can also configure advanced settings for each mode.

#### Launching EPU

After installing EPU from the motherboard support DVD, double-click the EPU tray icon to launch the program.



The first time you launch EPU, the following message will appear, asking you to run Calibration first. Running calibration allows the system to detect CPU properties to optimize power management.



Click **Run Calibration** and wait for a few seconds. Then, the EPU main menu appears.

#### EPU main menu



Refer to the software manual in the support DVD or visit the ASUS website at [www.asus.com](http://www.asus.com) for detailed software configuration.

### 4.3.4 ASUS Fan Xpert

Asus Fan Xpert allows you to adjust both the CPU and chassis fan speeds according to different ambient temperatures and your PC's system loading. The various fan profiles offer flexible controls of fan speeds to achieve a quiet and cool system environment.

#### Launching Fan Xpert

After installing AI Suite from the motherboard support DVD, launch Fan Xpert by double-clicking the **AI Suite** tray icon and then clicking the **Fan Xpert** button  on the AI Suite main window.

#### Using Fan Xpert



#### Fan profiles

- **Disable:** disables the **Fan Xpert** function.
- **Standard:** adjusts fan speed in a moderate pattern.
- **Silent:** minimizes fan speed for quiet fan operation.
- **Turbo:** maximizes the fan speed for the best cooling effect.
- **Intelligent:** automatically adjusts the CPU fan speed according to the ambient temperature.
- **Stable:** fixes the CPU fan speed to avoid noise caused by the unsteady fan rotation. The fan will speed up when the temperature exceeds 70°C.
- **User:** Allows you to configure the CPU fan profile under certain limitations.

### 4.3.5 ASUS TurboV

ASUS TurboV allows you to easily overclock without exiting or rebooting the OS, and set up the best O.C. settings for different scenarios.



Refer to the CPU documentation before adjusting CPU voltage settings. Setting a high voltage may damage the CPU permanently, and setting a low voltage may make the system unstable.



- Only Intel® Core™ i7 Extreme Edition processors support the CPU Ratio function.
- For system stability, all changes made in ASUS TurboV will not be saved to BIOS settings and will not be kept on the next system boot. Use the **Save Profile** function to save your customized overclocking settings and manually load the profile after Windows starts.
- For system stability, set ASUS EPU to **High Performance** Mode while using ASUS TurboV.

### Launching ASUS TurboV

1. Install the ASUS TurboV utility from the motherboard support DVD.
2. Click **Start > All Programs > ASUS > TurboV > TurboV**.

Save the current settings as a new profile

The screenshot shows the ASUS TurboV utility window. At the top, there's a 'Save Profile' button. Below it, the 'Profiles' dropdown is set to 'Default'. The main area is divided into 'Default settings' and 'Advanced settings'. The 'Default settings' section includes sliders for CPU Frequency (133 MHz), CPU Voltage (0.85000 V), DRAM Voltage (1.50 V), and CPU Vlt (1.20000 V). The 'Advanced settings' section is further divided into 'Advance Mode' and 'CPU Ratio'. The 'CPU Ratio' section has a slider for adjusting the CPU core ratio. Below that, there are sections for 'CPU/Chip Voltage' and 'DRAM Reference Voltage', each with multiple sliders for different components. At the bottom, there are 'Apply' and 'Undo' buttons.

Annotations in the image include:

- Target settings:** Points to the 'Profiles' dropdown.
- Default settings:** Points to the 'CPU Frequency', 'CPU Voltage', 'DRAM Voltage', and 'CPU Vlt' sliders.
- Click to show more settings:** Points to the 'More Setting' button.
- Advanced CPU and chipset voltage settings:** Points to the 'Advance Mode' and 'CPU Ratio' sections.
- Adjusts CPU core ratio:** Points to the CPU Ratio slider.
- Voltage Adjustment bars:** Points to the voltage sliders in the 'Default settings' section.
- Applies all changes immediately:** Points to the 'Apply' button.
- Undoes all changes without applying:** Points to the 'Undo' button.



- Set the **CPU Ratio Setting** item in BIOS to [Auto] before using the CPU Ratio function in TurboV. See Chapter 3 for details.
- For advanced overclock ability, adjust first the BIOS items, and then proceed more detailed adjustments using TurboV.
- Refer to the software manual in the support DVD or visit the ASUS website at [www.asus.com](http://www.asus.com) for detailed software configuration.

### 4.3.6 ASUS Express Gate SSD

ASUS Express Gate SSD is an instant-on environment that gives you quick access to the Internet, Skype, and viewing your pictures. Within a few seconds of powering on your computer, you will be at the Express Gate SSD menu where you can start the web browser, Skype, or other Express Gate SSD applications. It's a built-in utility, you can enjoy it without installation.

#### Notices about ASUS Express Gate SSD



- ASUS Express Gate SSD supports SATA devices in IDE mode only. See chapter 3 for BIOS setup details.
- ASUS Express Gate SSD supports SATA devices connected to **motherboard chipset-controlled onboard SATA ports** only. All onboard extended SATA ports and external SATA ports are NOT supported. See chapter 2 for the exact location of onboard SATA ports.
- ASUS Express Gate SSD supports file uploading from ODD and USB drives and downloading to USB drives only.
- Your monitor must support the screen resolution of **1024 x 768**, or ASUS Express Gate will be skipped during the booting process, and the existing OS will be launched directly.
- Installation of at least 1GB system memory is recommended for better performance.

#### The First Screen

Express Gate SSD's first screen appears within a few seconds after you power on the computer.



Click any of the application icons to enter Express Gate SSD environment and launch the selected application

Turn off the computer

Continue booting to existing OS when the timer above the Exit icon counts down to zero (0); click to immediately enter existing OS



- To enter the motherboard BIOS setup program, click **Exit** on the Express Gate First Screen, and then press the <Del> key during POST.
- Refer to the software manual in the support DVD or click  in the Express Gate environment for detailed software instructions.
- Express Gate complies with the OpenGL standard. Refer to <http://support.asus.com> for Express Gate source codes.



### 4.3.7 Audio configurations

The Realtek® audio CODEC provides 8-channel audio capability to deliver the ultimate audio experience on your computer. The software provides Jack-Sensing function, S/PDIF Out support, and interrupt capability. The CODEC also includes the Realtek® proprietary UAJ® (Universal Audio Jack) technology for all audio ports, eliminating cable connection errors and giving users plug and play convenience.

Follow the installation wizard to install the Realtek® Audio Driver from the support CD/DVD that came with the motherboard package.

If the Realtek audio software is correctly installed, you will find the **Realtek HD Audio Manager** icon on the taskbar. Double-click on the icon to display the Realtek HD Audio Manager.



Realtek HD Audio Manager

#### A. Realtek HD Audio Manager for Windows® Vista™

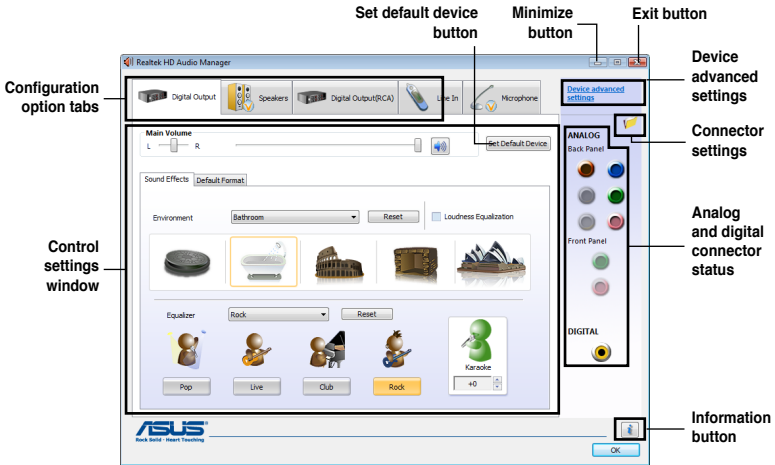

#### B. Realtek HD Audio Manager for Windows XP



## 4.4 RAID configurations

The motherboard comes with the Intel® ICH10R Southbridge controller that allows you to configure Serial ATA hard disk drives as RAID sets. The motherboard supports the following RAID configurations: RAID 0, RAID 1, RAID 10 and RAID 5.



- You must install Windows® XP Service Pack 2 or later versions before using Serial ATA hard disk drives. The Serial ATA RAID feature is available only if you are using Windows® XP SP2 or later versions.
- Due to Windows® XP / Vista limitation, a RAID array with the total capacity over 2TB cannot be set as a boot disk. A RAID array over 2TB can only be set as a data disk only.
- If you want to install a Windows® operating system to a hard disk drive included in a RAID set, you have to create a RAID driver disk and load the RAID driver during OS installation. Refer to section 4.5 **Creating a RAID driver disk** for details.

### 4.4.1 RAID definitions

**RAID 0 (Data striping)** optimizes two identical hard disk drives to read and write data in parallel, interleaved stacks. Two hard disks perform the same work as a single drive but at a sustained data transfer rate, double that of a single disk alone, thus improving data access and storage. Use of two new identical hard disk drives is required for this setup.

**RAID 1 (Data mirroring)** copies and maintains an identical image of data from one drive to a second drive. If one drive fails, the disk array management software directs all applications to the surviving drive as it contains a complete copy of the data in the other drive. This RAID configuration provides data protection and increases fault tolerance to the entire system. Use two new drives or use an existing drive and a new drive for this setup. The new drive must be of the same size or larger than the existing drive.

**RAID 5** stripes both data and parity information across three or more hard disk drives. Among the advantages of RAID 5 configuration include better HDD performance, fault tolerance, and higher storage capacity. The RAID 5 configuration is best suited for transaction processing, relational database applications, enterprise resource planning, and other business systems. Use a minimum of three identical hard disk drives for this setup.

**RAID 10** is data striping and data mirroring combined without parity (redundancy data) having to be calculated and written. With the RAID 10 configuration you get all the benefits of both RAID 0 and RAID 1 configurations. Use four new hard disk drives or use an existing drive and three new drives for this setup.

**Intel® Matrix Storage.** The Intel® Matrix Storage technology supported by the ICH10R chip allows you to create a RAID 0, RAID 1, RAID 5, and RAID 10 functions to improve both system performance and data safety. You can also combine two RAID sets to get higher performance, capacity, or fault tolerance provided by the difference RAID function. For example, RAID 0 and RAID 1 set can be created by using only two identical hard disk drives.

## 4.4.2 Installing Serial ATA hard disks

The motherboard supports Serial ATA hard disk drives. For optimal performance, install identical drives of the same model and capacity when creating a disk array.

To install the SATA hard disks for a RAID configuration:

1. Install the SATA hard disks into the drive bays.
2. Connect the SATA signal cables.
3. Connect a SATA power cable to the power connector on each drive.

## 4.4.3 Setting the RAID item in BIOS

You must enable the RAID function in the BIOS Setup before creating RAID set(s) using SATA HDDs. To do this:

1. Enter the BIOS Setup during POST.
2. Go to the **Main** menu > **Storage Configuration**, and then press <Enter>.
3. Set the **Configure SATA as** item to [RAID].
4. Save your changes, and then exit the BIOS Setup.



Refer to Chapter 3 for details on entering and navigating through the BIOS Setup.



Due to chipset limitation, when set any of SATA ports to RAID mode, all SATA ports run at RAID mode together.

## 4.4.4 Intel® Matrix Storage Manager option ROM utility

To enter the Intel® Matrix Storage Manager option ROM utility:

1. Turn on the system.
2. During POST, press <Ctrl> + <I> to display the utility main menu.

```
Intel(R) Matrix Storage Manager option ROM v8.0.0.1038 ICH10R wRAID5
Copyright(C) 2003-08 Intel Corporation. All Rights Reserved.

[ MAIN MENU ]
1. Create RAID Volume
2. Delete RAID Volume
3. Reset Disks to Non-RAID
4. Exit

[ DISK/VOLUME INFORMATION ]

RAID Volumes:
None defined.

Physical Disks:
Port Drive Model Serial # Size Type/Status (Vol ID)
0 ST3160812AS 9LS0HJ74 149.0GB Non-RAID Disk
1 ST3160812AS 9LS0F4HL 149.0GB Non-RAID Disk
2 ST3160812AS 3LS0JYL8 149.0GB Non-RAID Disk
3 ST3160812AS 9LS0BJ5H 149.0GB Non-RAID Disk

[↑↓]-Select [ESC]-Exit [ENTER]-Select Menu
```

The navigation keys at the bottom of the screen allow you to move through the menus and select the menu options.



The RAID BIOS setup screens shown in this section are for reference only and may not exactly match the items on your screen.



The utility supports maximum four hard disk drives for RAID configuration.

## Creating a RAID set

To create a RAID set:

1. From the utility main menu, select **1. Create RAID Volume** and press <Enter>. The following screen appears:

```
Intel(R) Matrix Storage Manager option ROM v8.0.0.1038 ICH10R wRAID5
Copyright(C) 2003-08 Intel Corporation. All Rights Reserved.

-----[ CREATE VOLUME MENU ]-----
Name: Volume0
RAID Level: RAID0(Stripe)
Disks: Select Disks
Strip Size: 128KB
Capacity: 0.0 GB

Create Volume

-----[ HELP ]-----

Enter a unique volume name that has no special characters and is
16 characters or less.

[↑↓]-Change [TAB]-Next [ESC]-Previous Menu [ENTER]-Select
```

2. Enter a name for the RAID set and press <Enter>.
3. When the **RAID Level** item is selected, press the up/down arrow key to select a RAID level to create, and then press <Enter>.
4. When the **Disks** item is selected, press <Enter> to select the hard disk drives you want to include in the RAID set. The **SELECT DISKS** screen appears:

```
[ SELECT DISKS ]
Port Drive Model Serial # Size Status
0 ST3160812AS 9LS0HAX1 149.0GB Non-RAID Disk
1 ST3160812AS 9LS0F4HL 149.0GB Non-RAID Disk
2 ST3160812AS 3LS0JYL8 149.0GB Non-RAID Disk
3 ST3160812AS 9LS0BJ5H 149.0GB Non-RAID Disk

Select 2 to 6 disks to use in creating the volume.

[↑↓]-Prev/Next [SPACE]-SelectDisk [ENTER]-Done
```

5. Use the up/down arrow key to select a drive, and then press <Space> to select. A small triangle marks the selected drive. Press <Enter> after completing your selection.
6. Use the up/down arrow key to select the stripe size for the RAID array (for RAID 0, 10 and 5 only), and then press <Enter>. The available stripe size values range from 4KB to 128KB. The following are typical values:  
RAID 0: 128KB  
RAID 10: 64KB  
RAID 5: 64KB



---

We recommend a lower stripe size for server systems, and a higher stripe size for multimedia computer systems used mainly for audio and video editing.

---

7. When the **Capacity** item is selected, enter the RAID volume capacity that you want and press <Enter>. The default value indicates the maximum allowed capacity.
8. When the **Create Volume** item is selected, press <Enter>. The following warning message appears:



9. Press <Y> to create the RAID volume and return to the main menu, or <N> to go back to the **CREATE VOLUME** menu.

## Deleting a RAID set



Take caution when deleting a RAID set. You will lose all data on the hard disk drives when you delete a RAID set.

To delete a RAID set:

1. From the utility main menu, select **2. Delete RAID Volume** and press <Enter>. The following screen appears:

```
Intel(R) Matrix Storage Manager option ROM v8.0.0.1038 ICH10R wRAID5
Copyright(C) 2003-08 Intel Corporation. All Rights Reserved.

[ DELETE VOLUME MENU ]

Name      Level      Drives  Capacity  Status  Bootable
Volume0   RAID0(Stripe)  2       298.0GB   Normal  Yes

[ HELP ]

Deleting a volume will reset the disks to non-RAID.
WARNING: ALL DISK DATA WILL BE DELETED.

[↑]-Select      [ESC]-Previous Menu  [DEL]-Delete Volume
```

2. Use the up/down arrow key to select the RAID set you want to delete, and then press <Del>. The following warning message appears:

```
[ DELETE VOLUME VERIFICATION ]

ALL DATA IN THE VOLUME WILL BE LOST!

Are you sure you want to delete volume "Volume0"? (Y/N) :
```

3. Press <Y> to delete the RAID set and return to the utility main menu, or press <N> to return to the **DELETE VOLUME** menu.

## Exiting the Intel® Matrix Storage Manager

To exit the utility:

1. From the utility main menu, select **4. Exit**, and then press <Enter>. The following warning message appears:

```
[ CONFIRM EXIT ]

Are you sure you want to exit? (Y/N) :
```

2. Press <Y> to exit or press <N> to return to the utility main menu.

## 4.5 Creating a RAID driver disk

A floppy disk with the RAID driver is required when installing Windows® XP operating system on a hard disk drive that is included in a RAID set. For Windows® Vista or later operating systems, use either a floppy disk or a USB flash drive with the RAID driver.



- **The motherboard does not provide a floppy drive connector.** You have to use a USB floppy disk drive when creating a **SATA RAID driver disk**.
- Windows® XP may not recognize the USB floppy disk drive due to Windows® XP limitation. To work around this OS limitation, refer to section **4.5.4 Using a USB floppy disk drive**.

### 4.5.1 Creating a RAID driver disk without entering the OS

To create a RAID/SATA driver disk without entering the OS:

1. Boot your computer.
2. Press <Del> during POST to enter the BIOS setup utility.
3. Set the optical drive as the primary boot device.
4. Insert the support DVD into the optical drive.
5. Save changes and exit BIOS.
6. When the **Make Disk** menu appears, press <a> or <b> to create a 32/64bit **Intel ICH10R RAID driver disk**.
7. Insert a formatted floppy disk into the USB floppy disk drive, then press <Enter>.
8. Follow the succeeding screen instructions to complete the process.

### 4.5.2 Creating a RAID driver disk in Windows®

To create a RAID driver disk in Windows®:

1. Start Windows®.
2. Plug the USB floppy disk drive and insert a floppy disk.
3. Place the motherboard support DVD into the optical drive.
4. Go to the **Make Disk** menu, and then click **Intel ICH10R 32/64 bit RAID Driver Disk** to create an Intel® ICH10R RAID driver disk.
5. Select USB floppy disk drive as the destination disk.
6. Follow the succeeding screen instructions to complete the process.



Write-protect the floppy disk to avoid a computer virus infection.

### 4.5.3 Installing the RAID driver during Windows® OS installation

To install the RAID driver in Windows® XP:

1. During the OS installation, the system prompts you to press the F6 key to install third-party SCSI or RAID driver.
2. Press <F6>, and then insert the floppy disk with RAID driver into the USB floppy disk drive.
3. When prompted to select the SCSI adapter to install, ensure that you select **Intel(R) SATA RAID Controller (Desktop ICH10R)**.
4. Follow the succeeding screen instructions to complete the installation.

To install the RAID driver in Windows® Vista™:

1. Insert the floppy disk/USB device with RAID driver into the USB floppy disk drive/USB port.
2. During the OS installation, select **Intel(R) SATA RAID Controller (Desktop ICH10R)**.
3. Follow the succeeding screen instructions to complete the installation.



## 4.5.4 Using a USB floppy disk drive

Due to OS limitation, Windows® XP may not recognize the USB floppy disk drive when you install the RAID driver from a floppy disk during the OS installation.

To solve this issue, add the USB floppy disk drive's Vendor ID (VID) and Product ID (PID) to the floppy disk containing the RAID driver. Refer to the steps below:

1. Using another computer, plug the USB floppy disk drive, and insert the floppy disk containing the RAID driver.
2. Right-click **My Computer** on the Windows® desktop or **start** menu, and then select **Manage** from the pop-up window.

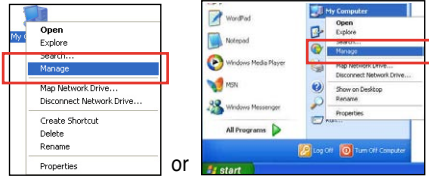

3. Select **Device Manager**. From the **Universal Serial Bus controllers**, right-click **xxxxxx USB Floppy**, and then select **Properties** from the pop-up window.



The name of the USB floppy disk drive varies with different vendors.

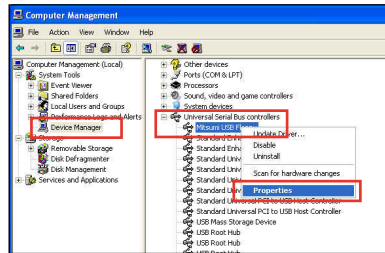

4. Click **Details** tab. The Vendor ID (VID) and Product ID (PID) are displayed.

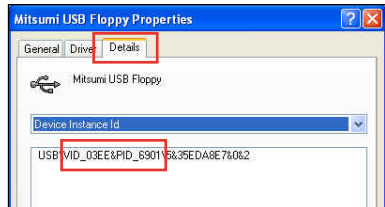

5. Browse the contents of the RAID driver disk to locate the file **txtsetup.oem**.
6. Double-click the file. A window appears, allowing you to select the program for opening the oem file.

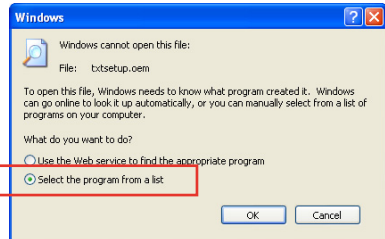

7. Use Notepad to open the file.

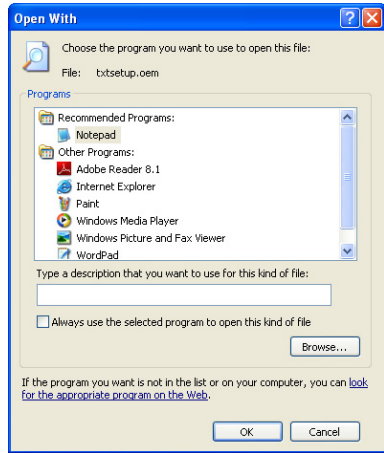

8. Find the **[HardwareIds.scsi.iaAHCI\_ICH10R]** and **[HardwareIds.scsi.iaStor\_ICH8RICH9RICH10RDO]** sections in the **txtsetup.oem** file.
9. Type the following line to the bottom of the two sections:  
**id = "USB\VID\_xxxx&PID\_xxxx", "usbstor"**

```
[HardwareIds.scsi.iaAHCI_ICH10R]
id = "PCI\VEN_8086&DEV_3A22&CC_0106", "iaStor"
id = "USB\VID_03EE&PID_6901", "usbstor" #--Mitsumi

[HardwareIds.scsi.iaStor_ICH8RICH9RICH10RDO]
id = "PCI\VEN_8086&DEV_2822&CC_0104", "iaStor"
id = "USB\VID_03EE&PID_6901", "usbstor" #--Mitsumi
```



Add the same line to both sections.



The VID and PID vary with different vendors.

10. Save and exit the file.

## 5.1 ATI® CrossFireX™ technology

The motherboard supports the ATI® CrossFireX™ technology that allows you to install multi-graphics processing units (GPU) graphics cards. Follow the installation procedures in this section.

### 5.1.1 Requirements

- In Dual CrossFireX mode, you should have two identical CrossFireX-ready graphics cards or one CrossFireX-ready dual-GPU graphics card that are ATI® certified.
- In Triple CrossFireX mode, you should have three identical CrossFireX-ready graphics cards that are ATI® certified.
- Ensure that your graphics card driver supports the ATI CrossFireX technology. Download the latest driver from the AMD website ([www.amd.com](http://www.amd.com)).
- Ensure that your power supply unit (PSU) can provide at least the minimum power required by your system. See page 2-35 for details.



- 
- We recommend that you install additional chassis fans for better thermal environment.
  - The ATI Triple CrossFireX technology is currently supported by Windows® Vista operating system only.
  - Visit the ATI Game website (<http://game.amd.com>) for the latest certified graphics card and the supported 3D application list.
- 

### 5.1.2 Before you begin

For ATI CrossFireX to work properly, you have to uninstall all existing graphics card drivers before installing ATI CrossFireX graphics cards to your system.

To uninstall existing graphics card drivers:

1. Close all current applications.
2. For Windows XP, go to **Control Panel > Add/Remove Programs**.  
For Windows Vista, go to **Control Panel > Programs and Features**.
3. Select your current graphics card driver/s.
4. For Windows XP, select **Add/Remove**.  
For Windows Vista, select **Uninstall**.
5. Turn off your computer.

### 5.1.3 Installing two CrossFire™ graphics cards



The following pictures are for reference only. The graphics cards and the motherboard layout may vary with models, but the installation steps remain the same.

1. Prepare two CrossFireX-ready graphics cards.
2. Insert the two graphics card into the PCIEX16 slots. If your motherboard has more than two PCIEX16 slots, refer to Chapter 2 in this user manual for the locations of the PCIEX16 slots recommended for multi-graphics card installation.
3. Ensure that the cards are properly seated on the slots.
4. Align and firmly insert the CrossFireX bridge connector to the goldfingers on each graphics card. Ensure that the connector is firmly in place.

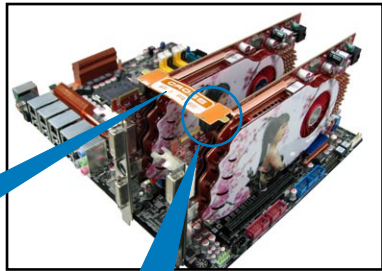
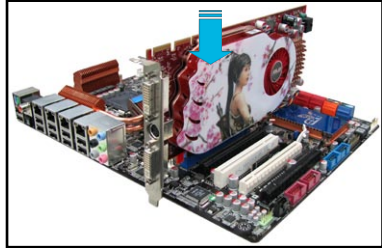

CrossFireX bridge

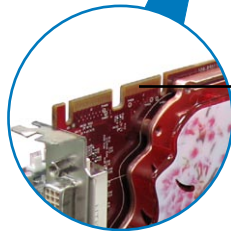

CrossFireX goldfingers

5. Connect two independent auxiliary power sources from the power supply to the two graphics cards separately.
6. Connect a VGA or a DVI cable to the graphics card.

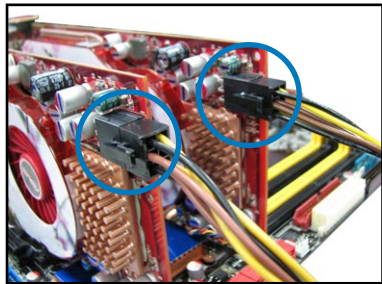

### 5.1.4 Installing three CrossFire™ graphics cards

1. Prepare three CrossFire-ready graphics cards.
2. Insert the three graphics card into the PCIEX16 slots. If your motherboard has more than three PCIEX16 slots, refer to Chapter 2 in this user manual for the locations of the PCIEX16 slots recommended for multi-graphics card installation.
3. Ensure that the cards are properly seated on the slots.
4. Align and firmly insert the two CrossFire bridge connectors to the goldfingers on each graphics card. Ensure that the connectors are firmly in place.

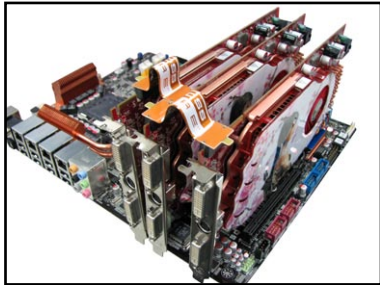

5. Connect three independent auxiliary power sources from the power supply to the three graphics cards separately.
6. Connect a VGA or a DVI cable to the graphics card.

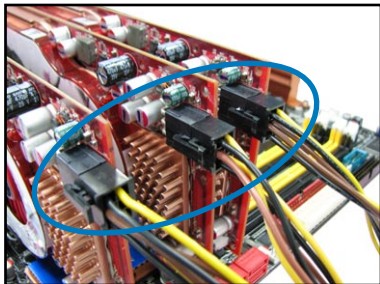

## 5.1.5 Installing the device drivers

Refer to the documentation that came with your graphics card package to install the device drivers.



- Ensure that your PCI Express graphics card driver supports the ATI® CrossFireX™ technology. Download the latest driver from the AMD website ([www.amd.com](http://www.amd.com)).
- If you are using a Triple CrossFireX system, ensure to install the ATI Catalyst® driver under Windows® Vista™ OS. The ATI Triple CrossFireX technology is currently supported by Windows® Vista™ only.

## 5.1.6 Enabling the ATI® CrossFireX™ technology

After installing your graphics cards and the device drivers, enable the CrossFireX™ feature through the ATI Catalyst™ Control Center in Windows environment.

### Launching the ATI Catalyst Control Center

To launch the ATI Catalyst Control Center:

1. Right-click on the Windows® desktop and select **Catalyst(TM) Control Center**. You can also right-click the ATI icon in the Windows notification area and select **Catalyst Control Center**.

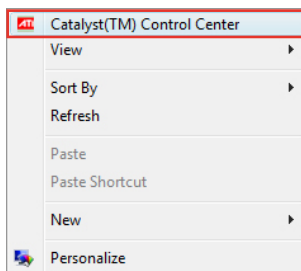

2. The **Catalyst Control Center Setup Assistant** appears when the system detects the existence of multi-graphics cards. Click **Go** to continue to the **Catalyst Control Center Advanced View** window.

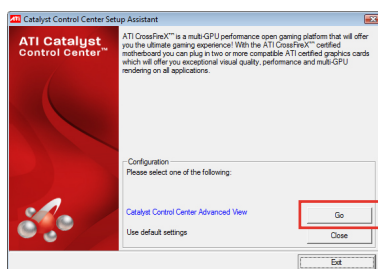

## Enabling Dual CrossFireX technology

1. In the Catalyst Control Center window, click **Graphics Settings > CrossFireX > Configure**.
2. From the Graphics Adapter list, select the graphics card to act as the display GPU.
3. Select **Enable CrossFireX**.
4. Click **Apply**, and then click **OK** to exit the window.



## Enabling Triple CrossFireX technology

1. In the Catalyst Control Center window, click **Graphics Settings > CrossFireX > Configure**.
2. From the Graphics Adapter list, select the graphics card to act as the display GPU.
3. Select **Enable CrossFireX**.
4. From the list, select the appropriate GPU combination to apply the CrossFireX technology.
5. Click **Apply**, and then click **OK** to exit the window.

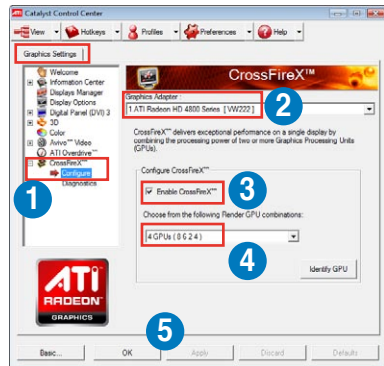

## 5.2 NVIDIA® SLI™ technology

The motherboard supports the NVIDIA® SLI™ (Scalable Link Interface) technology that allows you to install multi-graphics processing units (GPU) graphics cards. Follow the installation procedures in this section.

### 5.2.1 Requirements

- In Dual SLI mode, you should have two identical SLI-ready graphics cards that are NVIDIA® certified.
- In Triple SLI mode, you should have three identical SLI-ready graphics cards that are NVIDIA® certified.
- Ensure that your graphics card driver supports the NVIDIA SLI technology. Download the latest driver from the NVIDIA website ([www.nvidia.com](http://www.nvidia.com)).
- Ensure that your power supply unit (PSU) can provide at least the minimum power required by your system. See page 2-35 for details.



- 
- We recommend that you install additional chassis fans for better thermal environment.
  - The NVIDIA Triple SLI technology is supported by Windows® Vista™ operating system only.
  - Visit the NVIDIA zone website (<http://www.nzone.com>) for the latest certified graphics card and supported 3D application list.
-



## 5.2.2 Installing two SLI-ready graphics cards



The following pictures are for reference only. The graphics cards and the motherboard layout may vary with models, but the installation steps remain the same.

1. Prepare two SLI-ready graphics cards.
2. Insert the two graphics card into the PCIEX16 slots. If your motherboard has more than two PCIEX16 slots, refer to Chapter 2 in this user manual for the locations of the PCIEX16 slots recommended for multi-graphics card installation.
3. Ensure that the cards are properly seated on the slots.
4. Align and firmly insert the SLI bridge connector to the goldfingers on each graphics card. Ensure that the connector is firmly in place.
5. Connect two independent auxiliary power sources from the power supply to the two graphics cards separately.
6. Connect a VGA or a DVI cable to the graphics card.

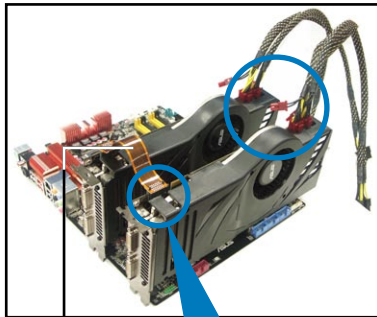
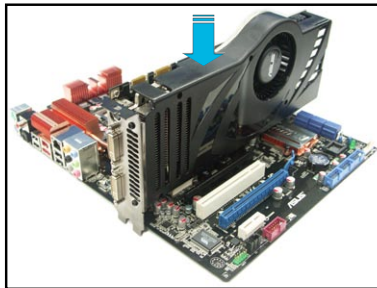

SLI bridge

Goldfingers

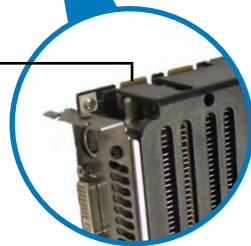

## 5.2.3 Installing three SLI-ready graphics cards

1. Prepare three SLI-ready graphics cards.
2. Insert the three graphics card into the PCIEX16 slots. If your motherboard has more than two PCIEX16 slots, refer to Chapter 2 in this user manual for the locations of the PCIEX16 slots recommended for multi-graphics card installation.
3. Ensure that the cards are properly seated on the slots.
4. Align and firmly insert the 3-Way SLI bridge connector to the goldfingers on each graphics card. Ensure that the connector is firmly in place.
5. Connect three independent auxiliary power sources from the power supply to the three graphics cards separately.
6. Connect a VGA or a DVI cable to the graphics card.

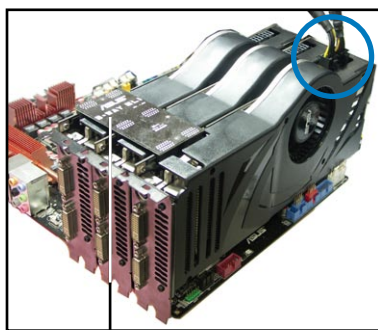
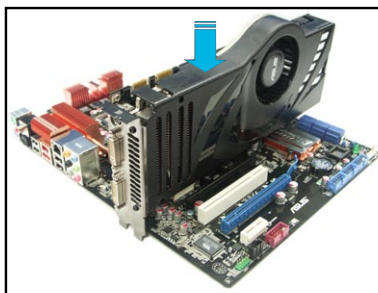

3-Way SLI bridge

## 5.2.4 Installing the device drivers

Refer to the documentation that came with your graphics card package to install the device drivers.



- Ensure that your PCI Express graphics card driver supports the NVIDIA® SLI™ technology. Download the latest driver from the NVIDIA website ([www.nvidia.com](http://www.nvidia.com)).
- If you are using a Triple SLI system, ensure to install the NVIDIA® 3-way SLI driver under Windows® Vista™. The NVIDIA 3-way SLI technology is supported by Windows® Vista™ only.

## 5.2.5 Enabling the NVIDIA® SLI™ technology

After installing your graphics cards and the device drivers, enable the SLI feature in NVIDIA® Control Panel under the Windows® Vista™ operating system.

### Launching the NVIDIA Control Panel

You can launch the NVIDIA Control Panel by the following two methods:

- A. Right click on the empty space of the Windows® desktop and select **NVIDIA Control Panel**.  
The NVIDIA Control Panel window appears (See Step B5 on page 5-11).

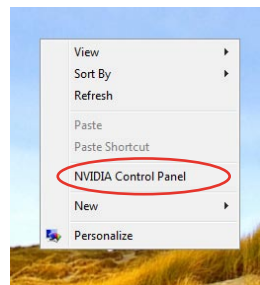

- B1. If you cannot see the NVIDIA Control Panel item in step (A), select **Personalize**.

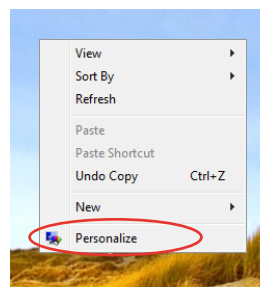

- B2. From the **Personalization** window, select **Display Settings**.

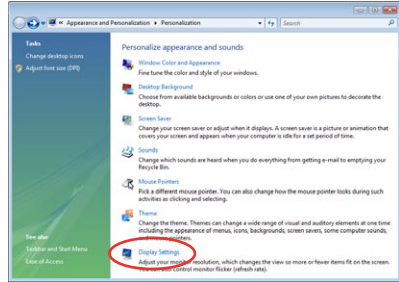

- B3. From the Display Settings dialog box, click **Advanced Settings**.

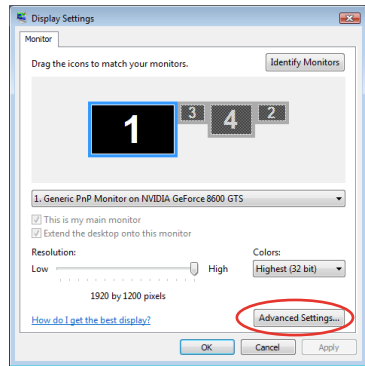

- B4. Select the **NVIDIA GeForce** tab, and then click **Start the NVIDIA Control Panel**.

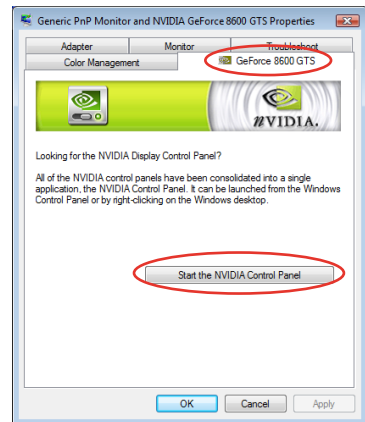

B5. The NVIDIA Control Panel window appears.

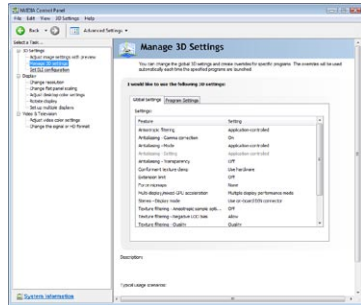

### Enabling Dual SLI settings

From the NVIDIA Control Panel window, select **Set SLI Configuration**. Click **Enable SLI** and set the display for viewing SLI rendered content. When done, click **Apply**.

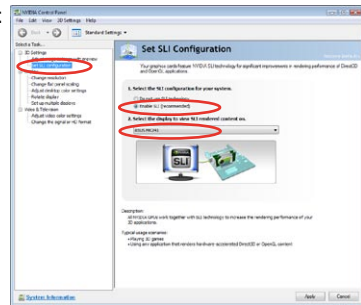

### Enabling Triple SLI settings

- From the NVIDIA Control Panel window, select **Set SLI Configuration**, and then click **Enable 3-way NVIDIA SLI**. When done, click **Apply**.
- Select the **3D Settings** tab and enable the **Show SLI Visual Indicators** item.

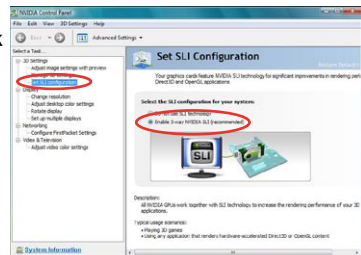

When this item is enabled, a green bar appears on the left side of the screen while 3D demonstrations are rendered, indicating the 3-way SLI status.

