

Z170-E

ASUS[®]

Motherboard

Copyright © 2015 ASUSTeK COMPUTER INC. All Rights Reserved.

No part of this manual, including the products and software described in it, may be reproduced, transmitted, transcribed, stored in a retrieval system, or translated into any language in any form or by any means, except documentation kept by the purchaser for backup purposes, without the express written permission of ASUSTeK COMPUTER INC. ("ASUS").

Product warranty or service will not be extended if: (1) the product is repaired, modified or altered, unless such repair, modification or alteration is authorized in writing by ASUS; or (2) the serial number of the product is defaced or missing.

ASUS PROVIDES THIS MANUAL "AS IS" WITHOUT WARRANTY OF ANY KIND, EITHER EXPRESS OR IMPLIED, INCLUDING BUT NOT LIMITED TO THE IMPLIED WARRANTIES OR CONDITIONS OF MERCHANTABILITY OR FITNESS FOR A PARTICULAR PURPOSE. IN NO EVENT SHALL ASUS, ITS DIRECTORS, OFFICERS, EMPLOYEES OR AGENTS BE LIABLE FOR ANY INDIRECT, SPECIAL, INCIDENTAL, OR CONSEQUENTIAL DAMAGES (INCLUDING DAMAGES FOR LOSS OF PROFITS, LOSS OF BUSINESS, LOSS OF USE OR DATA, INTERRUPTION OF BUSINESS AND THE LIKE), EVEN IF ASUS HAS BEEN ADVISED OF THE POSSIBILITY OF SUCH DAMAGES ARISING FROM ANY DEFECT OR ERROR IN THIS MANUAL OR PRODUCT.

SPECIFICATIONS AND INFORMATION CONTAINED IN THIS MANUAL ARE FURNISHED FOR INFORMATIONAL USE ONLY, AND ARE SUBJECT TO CHANGE AT ANY TIME WITHOUT NOTICE, AND SHOULD NOT BE CONSTRUED AS A COMMITMENT BY ASUS. ASUS ASSUMES NO RESPONSIBILITY OR LIABILITY FOR ANY ERRORS OR INACCURACIES THAT MAY APPEAR IN THIS MANUAL, INCLUDING THE PRODUCTS AND SOFTWARE DESCRIBED IN IT.

Products and corporate names appearing in this manual may or may not be registered trademarks or copyrights of their respective companies, and are used only for identification or explanation and to the owners' benefit, without intent to infringe.

Offer to Provide Source Code of Certain Software

This product contains copyrighted software that is licensed under the General Public License ("GPL"), under the Lesser General Public License Version ("LGPL") and/or other Free Open Source Software Licenses. Such software in this product is distributed without any warranty to the extent permitted by the applicable law. Copies of these licenses are included in this product.

Where the applicable license entitles you to the source code of such software and/or other additional data, you may obtain it for a period of three years after our last shipment of the product, either

(1) for free by downloading it from <http://support.asus.com/download>

or

(2) for the cost of reproduction and shipment, which is dependent on the preferred carrier and the location where you want to have it shipped to, by sending a request to:

ASUSTeK Computer Inc.
Legal Compliance Dept.
15 Li Te Rd.,
Beitou, Taipei 112
Taiwan

In your request please provide the name, model number and version, as stated in the About Box of the product for which you wish to obtain the corresponding source code and your contact details so that we can coordinate the terms and cost of shipment with you.

The source code will be distributed WITHOUT ANY WARRANTY and licensed under the same license as the corresponding binary/object code.

This offer is valid to anyone in receipt of this information.

ASUSTeK is eager to duly provide complete source code as required under various Free Open Source Software licenses. If however you encounter any problems in obtaining the full corresponding source code we would be much obliged if you give us a notification to the email address gpl@asus.com, stating the product and describing the problem (please DO NOT send large attachments such as source code archives, etc. to this email address).

Contents

Safety information.....	v
About this guide.....	v
Package contents.....	vii
Z170-E specifications summary.....	vii

Chapter 1: Product Introduction

1.1 Before you proceed	1-1
1.2 Motherboard overview.....	1-1
1.3 Central Processing Unit (CPU)	1-5
1.4 System memory	1-9
1.5 Expansion slots.....	1-17
1.6 Jumpers	1-20
1.7 Connectors	1-22
1.8 Onboard LEDs	1-35
1.9 Onboard buttons and switches	1-37
1.10 Software support.....	1-38

Chapter 2: BIOS Setup

2.1 Knowing BIOS	2-1
2.2 BIOS setup program	2-2
2.2.1 EZ Mode.....	2-3
2.2.2 Advanced Mode	2-4
2.2.3 QFan Control.....	2-7
2.2.4 EZ Tuning Wizard	2-9
2.3 My Favorites	2-12
2.4 Main menu	2-14
2.5 Ai Tweaker menu.....	2-16
2.6 Advanced menu	2-32
2.6.1 CPU Configuration	2-33
2.6.2 Platform Misc Configuration.....	2-35
2.6.3 System Agent (SA) Configuration	2-37
2.6.4 PCH Configuration	2-38
2.6.5 PCH Storage Configuration.....	2-38
2.6.6 USB Configuration	2-40
2.6.7 Network Stack Configuration.....	2-41
2.6.8 Onboard Devices Configuration	2-41
2.6.9 APM Configuration	2-44
2.6.10 HDD/SSD SMART Information	2-45
2.6.11 Intel(R) Thunderbolt	2-45

2.7	Monitor menu	2-46
2.8	Boot menu	2-51
2.9	Tool menu	2-57
2.9.1	ASUS EZ Flash 3 Utility	2-57
2.9.2	Secure Erase	2-57
2.9.3	ASUS O.C. Profile.....	2-59
2.9.4	ASUS DRAM SPD Information	2-60
2.9.5	Graphics Card Information	2-60
2.10	Exit menu.....	2-61
2.11	Updating BIOS.....	2-62
2.11.1	EZ Update	2-62
2.11.2	ASUS EZ Flash 3.....	2-63
2.11.3	ASUS CrashFree BIOS 3.....	2-65
2.12	Installing an operating system	2-66
2.12.1	Windows® 7 and USB 3.0 driver for 100 Series	2-66
 Appendices		
	Notices	A-1
	ASUS contact information.....	A-5

Safety information

Electrical safety

- To prevent electrical shock hazard, disconnect the power cable from the electrical outlet before relocating the system.
- When adding or removing devices to or from the system, ensure that the power cables for the devices are unplugged before the signal cables are connected. If possible, disconnect all power cables from the existing system before you add a device.
- Before connecting or removing signal cables from the motherboard, ensure that all power cables are unplugged.
- Seek professional assistance before using an adapter or extension cord. These devices could interrupt the grounding circuit.
- Ensure that your power supply is set to the correct voltage in your area. If you are not sure about the voltage of the electrical outlet you are using, contact your local power company.
- If the power supply is broken, do not try to fix it by yourself. Contact a qualified service technician or your retailer.

Operation safety

- Before installing the motherboard and adding components, carefully read all the manuals that came with the package.
- Before using the product, ensure all cables are correctly connected and the power cables are not damaged. If you detect any damage, contact your dealer immediately.
- To avoid short circuits, keep paper clips, screws, and staples away from connectors, slots, sockets and circuitry.
- Avoid dust, humidity, and temperature extremes. Do not place the product in any area where it may be exposed to moisture.
- Place the product on a stable surface.
- If you encounter technical problems with the product, contact a qualified service technician or your retailer.

About this guide

This user guide contains the information you need when installing and configuring the motherboard.

How this guide is organized

This guide contains the following parts:

- **Chapter 1: Product Introduction**
This chapter describes the features of the motherboard and the new technology it supports. It includes descriptions of the switches, jumpers, and connectors on the motherboard.
- **Chapter 2: BIOS Setup**
This chapter discusses changing system settings through the BIOS Setup menus. Detailed descriptions for the BIOS parameters are also provided.

Where to find more information

Refer to the following sources for additional information and for product and software updates.

1. ASUS websites

The ASUS website provides updated information on ASUS hardware and software products. Refer to the ASUS contact information.

2. Optional documentation

Your product package may include optional documentation, such as warranty flyers, that may have been added by your dealer. These documents are not part of the standard package.

Conventions used in this guide

To ensure that you perform certain tasks properly, take note of the following symbols used throughout this manual.



DANGER/WARNING: Information to prevent injury to yourself when completing a task.



CAUTION: Information to prevent damage to the components when completing a task.



IMPORTANT: Instructions that you **MUST** follow to complete a task.



NOTE: Tips and additional information to help you complete a task.

Typography

Bold text

Indicates a menu or an item to select.

Italics

Used to emphasize a word or a phrase.

<Key>

Keys enclosed in the less-than and greater-than sign means that you must press the enclosed key.

Example: <Enter> means that you must press the Enter or Return key.

<Key1> + <Key2> + <Key3>

If you must press two or more keys simultaneously, the key names are linked with a plus sign (+).

Package contents

Check your motherboard package for the following items:

Motherboard	ASUS Z170-E Motherboard
Cables	2 x Serial ATA 6.0 Gb/s cables 1 x ASUS SLI bridge connector
Accessories	1 x M.2 screw package 1 x CPU installation tool
Application DVD	Support DVD
Documentation	User Guide



If any of the above items is damaged or missing, contact your retailer.

Z170-E specifications summary

CPU	LGA1151 socket for 6th Generation Intel® Core™ i7/ i5/ i3/Pentium®/Celeron® Processors Supports 14nm CPU Supports Intel® Turbo Boost Technology 2.0* * The Intel® Turbo Boost Technology 2.0 support depends on the CPU types.
Chipset	Intel® Z170 Express Chipset
Memory	4 x DIMM, max. 64GB, DDR4 3466(O.C.)/3400(O.C.)/3333(O.C.)/3300(O.C.)/3200(O.C.)/3000(O.C.)/2800(O.C.)/2666(O.C.)/2400(O.C.)/2133 MHz, non-ECC, un-buffered memory Dual channel memory architecture Supports Intel® Extreme Memory Profile (XMP) * Hyper DIMM support is subject to the physical characteristics of individual CPUs. Please refer to Memory QVL (Qualified Vendors List) for details.
Expansion Slots	2 x PCI Express 3.0/2.0 x16 slots (single at x16 or dual at x8/x8 mode) 1 x PCI Express 3.0/2.0 x16 slot (max. at x2 mode, compatible with PCIe x1 and x2 devices) 3 x PCI Express 3.0/2.0 x1 slots
VGA	Integrated Graphics Processor- Intel® HD Graphics support Multi-VGA output support: HDMI/DVI-D ports Supports HDMI 1.4b with max. resolution 4096 x 2160@24Hz / 2560 x 1600@60Hz Supports DVI-D with max. resolution 1920 x 1200@60Hz Supports Intel® InTru™ 3D/Quick Sync Video/Clear Video HD Technology/Insider™ Supports up to 2 displays simultaneously Maximum shared memory of 512MB

(continued on the next page)

Z170-E specifications summary

Multi-GPU Support	<p>Supports NVIDIA® 2-way/Quad-GPU SLI™ Technology (with 2 PCIe x16 graphics cards)</p> <p>Supports AMD® 2-way/Quad-GPU CrossFireX™ Technology</p>
Storage	<p>Intel® Z170 Express Chipset with RAID 0, 1, 5, 10 and Intel Rapid Storage Technology 14 support</p> <ul style="list-style-type: none"> - 1 x SATA Express port (compatible with 2 x SATA 6.0 Gb/s ports) - 6 x SATA 6.0 Gb/s ports (gray, 2 from SATA Express) - Supports Intel® Smart Response Technology* - 1 x M.2 Socket 3 with M Key, type 2242/2260/2280/22110 storage devices support (both SATA & PCIe mode)** <p>* These functions will work depending on the CPU installed.</p> <p>** M.2 shares SATA mode with SATA Express. Change this item before installing M.2 SATA devices.</p>
LAN	<p>Gigabit Intel LAN connection- 802.3az Energy Efficient Ethernet (EEE) appliance</p> <p>Intel® I219-V Gigabit LAN- Dual interconnect between the integrated Media Access Controller (MAC) and physical layer (PHY)</p> <p>ASUS LANGuard</p> <p>ASUS Turbo LAN Utility</p>
Audio	<p>Realtek® ALC887 8-channel high definition audio CODEC</p> <ul style="list-style-type: none"> - Separate layer for left and right track, ensuring both sound deliver equal quality - Top notch audio sensation delivers according to the audio configuration - Audio shielding ensures precise analog/digital separation and greatly reduced multi-lateral interference - Unique de-pop circuit to reduce start-up popping noise to audio outputs - Premium Japan-made audio capacitors provides warm, natural, and immersive sound with exceptional clarity and fidelity - Absolute Pitch 192khz/24bit true BD lossless sound - Supports jack-detection, multi-streaming, front panel jack-retasking (MIC)
USB	<p>Intel® Z170 Express Chipset- supports ASUS USB 3.1 Boost</p> <ul style="list-style-type: none"> - 6 x USB 3.0/2.0 ports (4 ports at mid-board, 2 ports at back panel, blue) - 6 x USB 2.0/1.1 ports (4 ports at mid-board, 2 ports at back panel) <p>ASMedia® USB 3.1 controllers- supports ASUS USB 3.1 Boost and 3A power output</p> <ul style="list-style-type: none"> - 1 x USB 3.1/3.0/2.0 port at back panel (Type-C)

(continued on the next page)

Z170-E specifications summary

ASUS Exclusive Features

Superb Performance

OC Design - ASUS PRO Clock Technology

- Full BCLK range for extreme overclocking performance

5-Way Optimization

- Whole system optimization with a single click! Perfectly consolidates better CPU performance, power saving, digital power control, system cooling and app usages

DIGI+ VRM

- CPU Power: Digital 4-phase power design
- iGPU Power: Digital 2-phase power design

TPU

- Auto Tuning, TPU, GPU Boost

EPU

- EPU

Fan Xpert 3 featuring Fan Auto Tuning function and multiple thermistors selection for optimized system cooling control

Turbo App featuring system performance tuning, network priority, and audio scene configuration for selected applications

UEFI BIOS

- Most advanced options with fast response time

Special Memory O.C. Design

- Superb memory O.C. capability under full load by minimizing the coupling noise and signal reflection effect

PC Cleaner

- Fast and easy way to get rid of unnecessary junk files

Remote Entertainment

Media Streamer

- Pipe music or movies from your PC to a smart TV, your entertainment goes wherever you go!
- Media Streamer app for portable smartphone/tablet, supporting iOS 7 & Android 4.0 systems and above

HyStream

- Stream iOS devices' screen on your PC screen*

* Contact your device vendor for supporting information.

(continued on the next page)

Z170-E specifications summary

ASUS Exclusive Features	<p>eSports Champions</p> <p>Turbo LAN</p> <ul style="list-style-type: none">- Fast and smooth online gaming with lower pings and less lags <p>Crystal Sound 2</p> <ul style="list-style-type: none">- Hear the cleanest sound with dedicated audio design onboard! <p>Turbo APP</p> <ul style="list-style-type: none">- Tailored app performance, network priority and audio configuration for your needs <p>EZ DIY</p> <p>Push Notice</p> <ul style="list-style-type: none">- Monitor your PC status with smart devices in real time <p>UEFI BIOS EZ Mode featuring friendly graphics user interface</p> <ul style="list-style-type: none">- CrashFree BIOS 3- EZ Flash 3 <p>ASUS Q-Design</p> <ul style="list-style-type: none">- ASUS Q-LED (CPU, DRAM, VGA, Boot Device LED)- ASUS Q-Slot- ASUS Q-DIMM
ASUS Special Features	<p>ASUS 5X Protection II</p> <ul style="list-style-type: none">- ASUS LANGuard - 2.5x higher surge tolerance- ASUS Overvoltage Protection - World-class circuit-protecting power design- ASUS DIGI+ VRM - 4 Phase digital power design- ASUS DRAM Overcurrent Protection - Prevents damage from short circuits- ASUS Stainless-Steel Back I/O - 3x corrosion-resistance for greater durability <p>Special Features</p> <ul style="list-style-type: none">- Mobo Connect- LANGuard- USB 3.1 Boost- Ai Charger+- AI Suite 3- MemOK!- EZ XMP

(continued on the next page)

Z170-E specifications summary

ASUS Quiet Thermal Solution	Quiet Thermal Design: - ASUS Fan Xpert 3 - ASUS Fanless Design: Heat-sink solution
ASUS Exclusive Overclocking Features	Precision Tweaker 2: - CPU Core/Cache Voltage: Adjustable CPU Core/Cache Voltage at 0.005V increment - CPU Graphics Voltage: Adjustable CPU Graphics voltage at 0.005V increment - CPU VCCIO Voltage: Adjustable CPU VCCIO Voltage at 0.0125V increment - CPU System Agent Voltage: Adjustable CPU System Agent Voltage at 0.0125V increment - DRAM Voltage: 152-step Memory voltage control - PCH Core Voltage: 88-step Chipset voltage control SFS (Stepless Frequency Selection) - BCLK/PCIE frequency tuning from 40MHz up to 500MHz at 0.01MHz increment Overclocking Protection: - ASUS C.P.R.(CPU Parameter Recall)
Rear Panel I/O Ports	1 x PS/2 Keyboard/mouse combo port 1 x HDMI port 1 x DVI-D port 1 x Intel LAN (RJ45) port 1 x USB 3.1/3.0/2.0 port (Type C) 2 x USB 3.0/2.0 ports (blue) 2 x USB 2.0 ports 8-channel Audio I/O ports
Internal I/O Connectors	2 x USB 3.0/2.0 connectors support additional 4 USB ports (19-pin) 2 x USB 2.0/1/1 connectors support additional 4 USB ports 1 x M.2 Socket 3 (for M Key, type 2242/2260/2280/22110 storage devices) 1 x SATA Express connector (gray) 4 x SATA 6.0 Gb/s connectors (gray) 1 x CPU Fan connector (4-pin) for both 3-pin (DC mode) and 4-pin (PWM mode) CPU coolers control with auto detection support 1 x CPU OPT Fan connector (4-pin) 1 x Water Pump header (4-pin) 2 x Chassis Fan connectors (4-pin) for both 3-pin (DC mode) and 4-pin (PWM mode) coolers control 1 x Front panel audio connector (AAFP)

(continued on the next page)

Z170-E specifications summary

Internal I/O Connectors	<ul style="list-style-type: none"> 1 x S/PDIF out header 1 x Thunderbolt header (5-pin) for ASUS ThunderboltEX series support 1 x TPM connector 1 x COM port 1 x 24-pin EATX Power connector 1 x 8-pin EATX 12V Power connector 1 x System Panel 1 x Speaker header 1 x MemOK! button 1 x Clear CMOS jumper 1 x DRCT (Direct Key) connector 1 x 5-pin EXT_FAN (Extension Fan) connector
BIOS Features	128 Mb Flash ROM, UEFI AMI BIOS, PnP, DMI3.0, WfM2.0, SM BIOS 3.0, ACPI 5.0, Multi-language BIOS, ASUS EZ Flash 3, CrashFree BIOS 3, F11 EZ Tuning Wizard, F6 Qfan Control, F3 My Favorites, Quick Note, Last Modified log, F12 PrintScreen and ASUS DRAM SPD (Serial Presence Detect) memory information
Manageability	WfM 2.0, DMI 3.0, WOL by PME, PXE
Accessories	<ul style="list-style-type: none"> 2 x Serial ATA 6.0Gb/s cables 1 x ASUS SLI bridge connector 1 x M.2 screw package 1 x User's manual 1 x CPU installation tool
Support DVD	<ul style="list-style-type: none"> Drivers ASUS Utilities EZ Update Anti-virus software (OEM version)
Operating System Support	<ul style="list-style-type: none"> Windows® 10* Windows® 8.1* Windows® 7 <p>*64-bit supported only</p>
Form Factor	ATX Form Factor, 12"x 9.2" (30.5cm x 23.4cm)



Specifications are subject to change without notice.

Product Introduction

1

1.1 Before you proceed

Take note of the following precautions before you install motherboard components or change any motherboard settings.



-
- Unplug the power cord from the wall socket before touching any component.
 - Before handling components, use a grounded wrist strap or touch a safely grounded object or a metal object, such as the power supply case, to avoid damaging them due to static electricity.
 - Hold components by the edges to avoid touching the ICs on them.
 - Whenever you uninstall any component, place it on a grounded antistatic pad or in the bag that came with the component.
 - Before you install or remove any component, ensure that the ATX power supply is switched off or the power cord is detached from the power supply. Failure to do so may cause severe damage to the motherboard, peripherals, or components.
-

1.2 Motherboard overview

Before you install the motherboard, study the configuration of your chassis to ensure that the motherboard fits.



Unplug the power cord before installing or removing the motherboard. Failure to do so can cause you physical injury and damage to motherboard components.

1.2.1 Placement direction

When installing the motherboard, place it into the chassis in the correct orientation. The edge with external ports goes to the rear part of the chassis.

1.2.2 Screw holes

Place nine screws into the holes indicated by circles to secure the motherboard to the chassis.



Do not overtighten the screws! Doing so can damage the motherboard.

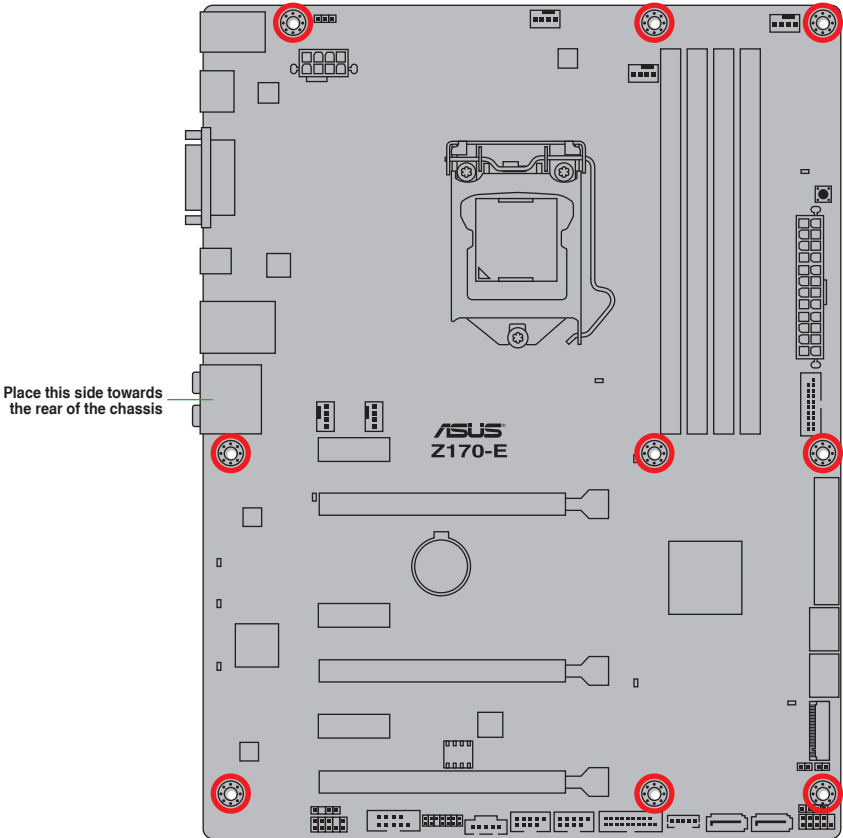

1.2.3 Motherboard layout

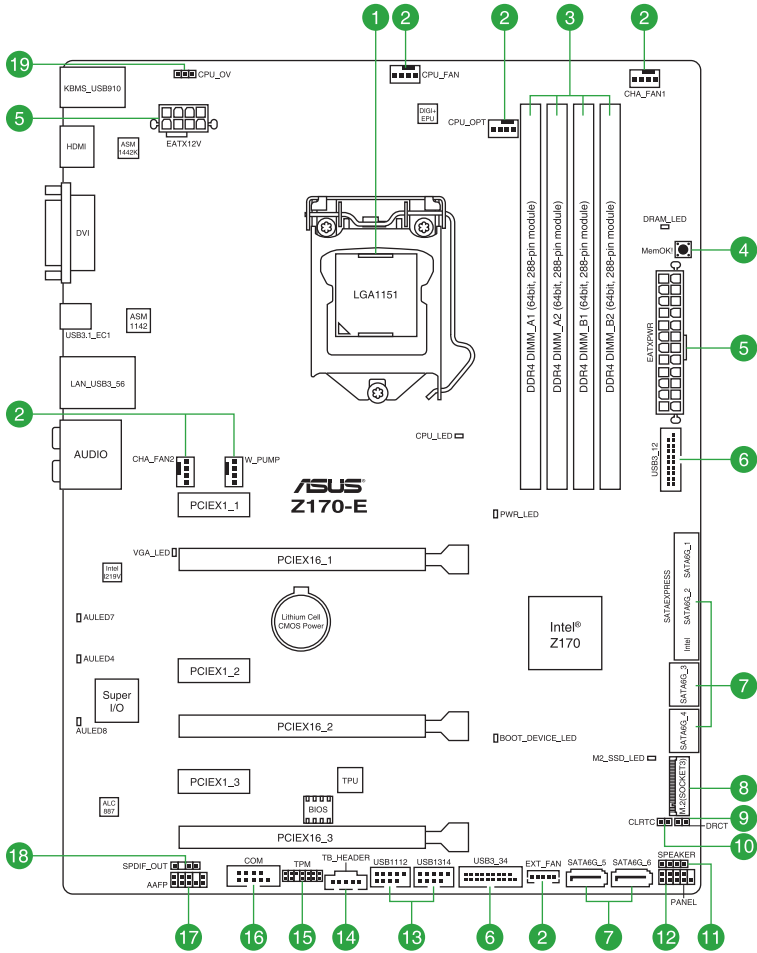

1.2.4 Layout contents

Connectors/Jumpers/Slots/LED		Page
1.	Intel® LGA1151 CPU socket	1-5
2.	CPU, water pump, CPU optional, extension, and chassis fan connectors (4-pin CPU_FAN; 4-pin W_PUMP; 4-pin CPU_OPT; 5-pin EXT_FAN; 4-pin CHA_FAN1-2)	1-26
3.	DDR4 DIMM slots	1-9
4.	MemOK! button	1-37
5.	ATX power connectors (24-pin EATXPWR, 8-pin EATX12V)	1-27
6.	USB 3.0 connectors (20-1 pin USB3_12, USB3_34)	1-33
7.	Intel® Z170 Serial ATA 6.0 Gb/s connectors (7-pin SATA6G_12, SATA6G_34, SATA6G_56, SATA Express)	1-25
8.	M.2 Socket 3	1-29
9.	DirectKey connector (2-pin DRCT)	1-28
10.	Clear RTC RAM (2-pin CLRRTC)	1-20
11.	System warning speaker header (4-pin SPEAKER)	1-30
12.	System panel connector (10-1 pin PANEL)	1-31
13.	USB 2.0 connectors (10-1 pin USB1112, USB1314)	1-32
14.	Thunderbolt header (5-pin TB_HEADER)	1-34
15.	TPM connector (14-1 pin TPM)	1-30
16.	Serial port connector (10-1 pin COM)	1-24
17.	Front panel audio connector (10-1 pin AAFP)	1-29
18.	Digital audio connector (4-1 pin SPDIF_OUT)	1-28
19.	CPU Over Voltage jumper (3-pin CPU_OV)	1-21

1.3 Central Processing Unit (CPU)

The motherboard comes with a surface mount LGA1151 socket designed for the 6th Generation Intel® Core™ i7/ i5/ i3, Pentium®, and Celeron® processors.

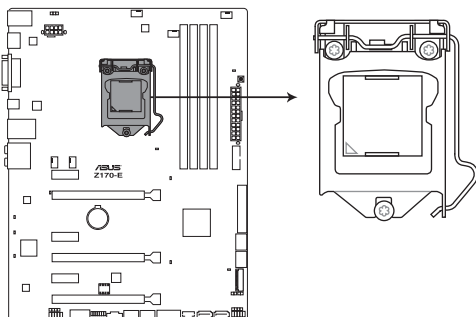

Z170-E CPU LGA1151



Ensure that you install the correct CPU designed for LGA1151 socket only. DO NOT install a CPU designed for other sockets on the LGA1151 socket.



- Ensure that all power cables are unplugged before installing the CPU.
 - Upon purchase of the motherboard, ensure that the PnP cap is on the socket and the socket contacts are not bent. Contact your retailer immediately if the PnP cap is missing, or if you see any damage to the PnP cap/socket contacts/motherboard components. ASUS will shoulder the cost of repair only if the damage is shipment/transit-related.
 - Keep the cap after installing the motherboard. ASUS will process Return Merchandise Authorization (RMA) requests only if the motherboard comes with the cap on the LGA1150 socket.
 - The product warranty does not cover damage to the socket contacts resulting from incorrect CPU installation/removal, or misplacement/loss/incorrect removal of the PnP cap.
-

1.3.1 Installing the CPU

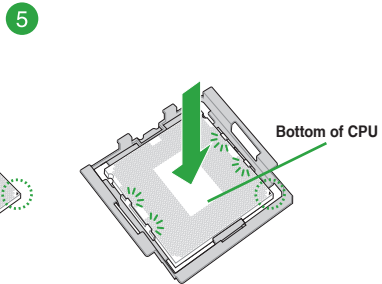
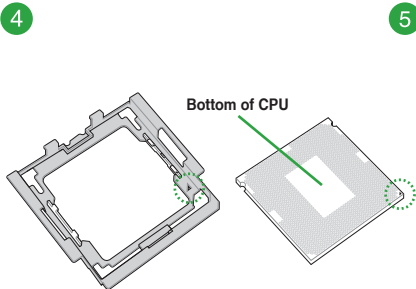
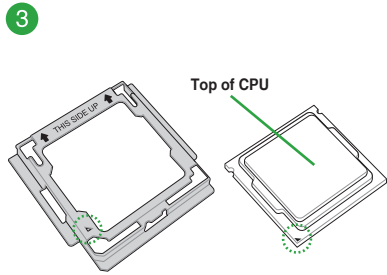
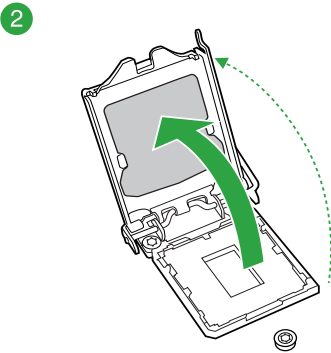
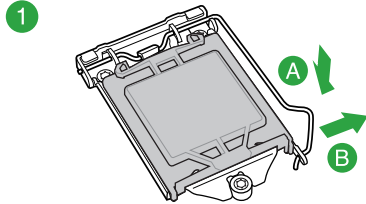
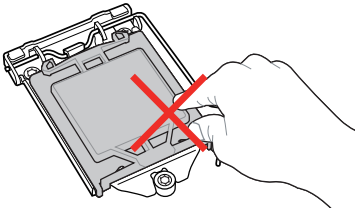

6

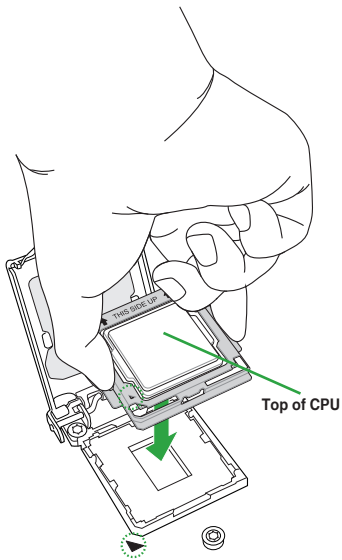

7

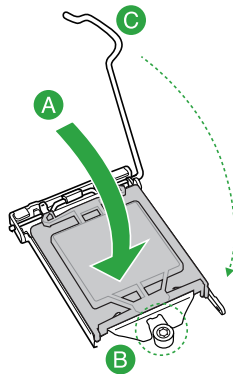

8

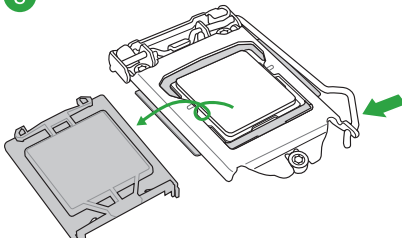

1.3.2 CPU heatsink and fan assembly installation

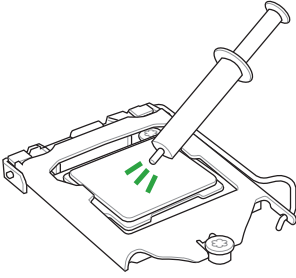

Apply the Thermal Interface Material to the CPU heatsink and CPU before you install the heatsink and fan, if necessary.

To install the CPU heatsink and fan assembly

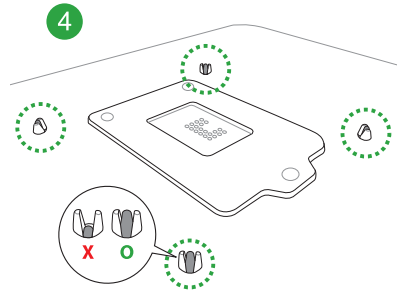
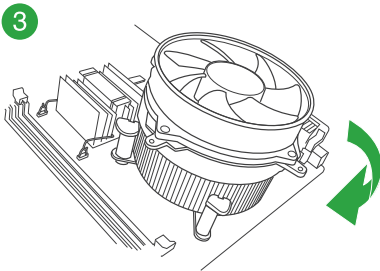
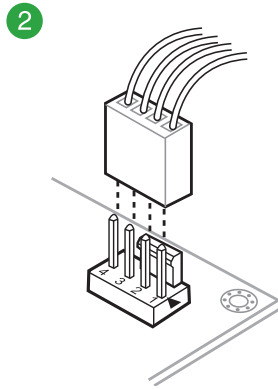
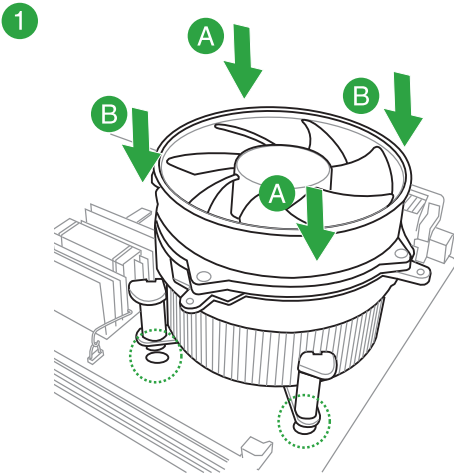

To uninstall the CPU heatsink and fan assembly

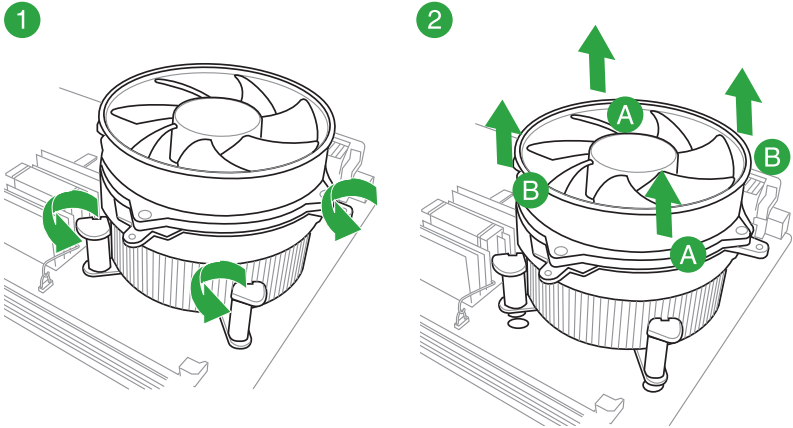

1.4 System memory

1.4.1 Overview

The motherboard comes with four Double Data Rate 4 (DDR4) Dual Inline Memory Modules (DIMM) slots.



A DDR4 module is notched differently from a DDR, DDR2, or DDR3 module. DO NOT install a DDR, DDR2, or DDR3 memory module to the DDR4 slot.

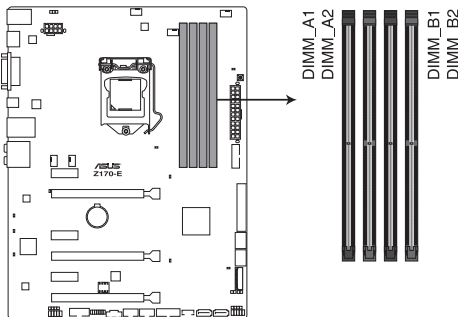

Z170-E 288-pin DDR4 DIMM socket

Recommended memory configurations

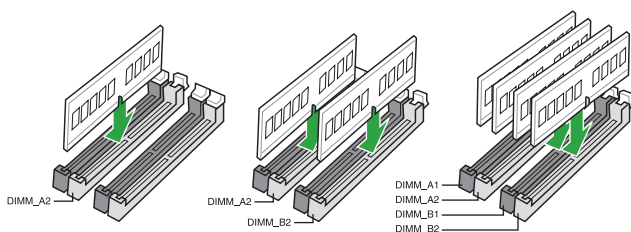

1.4.2 Memory configurations

You may install 1 GB, 2 GB, 4 GB, 8GB, and 16 GB unbuffered non-ECC DDR4 DIMMs into the DIMM sockets. You can refer to the recommended memory population below.



- You may install varying memory sizes in Channel A and Channel B. The system maps the total size of the lower-sized channel for the dual-channel configuration. Any excess memory from the higher-sized channel is then mapped for single-channel operation.
- Always install DIMMs with the same CAS latency. For optimal compatibility, we recommend that you install memory modules of the same version or date code (D/C) from the same vendor. Check with the retailer to get the correct memory modules.
- Due to the memory address limitation on 32-bit Windows® OS, when you install 4GB or more memory on the motherboard, the actual usable memory for the OS can be about 3GB or less. For effective use of memory, we recommend that you do any of the following:
 - a) Use a maximum of 3GB system memory if you are using a 32-bit Windows® OS.
 - b) Install a 64-bit Windows® OS when you want to install 4 GB or more on the motherboard.
 - c) For more details, refer to the Microsoft® support site at <http://support.microsoft.com/kb/929605/en-us>.
- This motherboard does not support DIMMs made up of 512 Mb (64 MB) chips or less.



- The default memory operation frequency is dependent on its Serial Presence Detect (SPD), which is the standard way of accessing information from a memory module. Under the default state, some memory modules for overclocking may operate at a lower frequency than the vendor-marked value. To operate at the vendor-marked or at a higher frequency, refer to section **2.5 Ai Tweaker menu** for manual memory frequency adjustment.
- For system stability, use a more efficient memory cooling system to support a full memory load (4 DIMMs).
- Visit the ASUS website at: www.asus.com for the latest QVL.

Z170-E Motherboard Qualified Vendors Lists (QVL)

DDR4 3466 (O.C.) MHz capability

Vendors	Part No.	Size	SS/DS	Chip Brand	Chip NO.	Timing	Voltage	DIMM socket support (Optional)		
								1	2	4
G.SKILL	F4-3466C16D-8GRK	8GB(4GB*2)	SS	Samsung	K4A4G085WD	16-18-18-38	1.35V		•	
G.SKILL	F4-3466C16D-8GTZ	8GB(4GB*2)	SS	Samsung	K4A4G085WD	16-18-18-38	1.35V		•	
G.SKILL	F4-3466C16D-8GVK	8GB(4GB*2)	SS	Samsung	K4A4G085WD	16-18-18-38	1.35V		•	

DDR4 3400 (O.C.) MHz capability

Vendors	Part No.	Size	SS/DS	Chip Brand	Chip NO.	Timing	Voltage	DIMM socket support (Optional)		
								1	2	4
CORSAIR	CMD16GX4M4B3400C16 ver. 4.23	16GB(4GB*4)	SS	Samsung	K4A4G085WD	16-18-18-38	1.35V		•	

DDR4 3333 (O.C.) MHz capability

Vendors	Part No.	Size	SS/DS	Chip Brand	Chip NO.	Timing	Voltage	DIMM socket support (Optional)		
								1	2	4
G.SKILL	F4-3333C16D-8GTZ	8GB(4GB*2)	SS	Samsung	K4A4G085WD	16-18-18-38	1.35V		•	
G.SKILL	F4-3333C16Q-16GRKD	16GB(4GB*4)	SS	Samsung	K4A4G085WD	16-16-16-36	1.35V		•	
CORSAIR	CMD16GX4M4B3333C16 ver.4.23	16GB(4GB*4)	SS	Samsung	K4A4G085WD	16-18-18-36	1.35V		•	
A-DATA	AX4U3333W4G16	16GB(4GB*4)	SS	SK Hynix	H5AN4G8NMFR	16-16-16-36	1.35V		•	

DDR4 3300 (O.C.) MHz capability

Vendors	Part No.	Size	SS/DS	Chip Brand	Chip NO.	Timing	Voltage	DIMM socket support (Optional)		
								1	2	4
G.SKILL	F4-3300C16Q-16GRK	16GB(4GB*4)	SS	Samsung	K4A4G085WD	16-16-16-36	1.35V	•	•	
G.SKILL	F4-3300C16D-8GTZ	8GB(4GB*2)	SS	Samsung	K4A4G085WD	16-18-18-38	1.35V		•	
CORSAIR	CMD16GX4M4B3300C16	16GB(4GB*4)	SS	Samsung	K4A4G085WD	16-18-18-36	1.35V		•	

DDR4 3200 (O.C.) MHz capability

Vendors	Part No.	Size	SS/DS	Chip Brand	Chip NO.	Timing	Voltage	DIMM socket support (Optional)		
								1	2	4
G.SKILL	F4-3200C16Q-16GRR	16GB(4GB*4)	SS	Samsung	K4A4G085WD	16-16-16-36	1.35V	•	•	
G.SKILL	F4-3200C16Q-16GRB	16GB(4GB*4)	SS	Samsung	K4A4G085WD	16-16-16-36	1.35V	•	•	
G.SKILL	F4-3200C16Q-16GRK	16GB(4GB*4)	SS	Samsung	K4A4G085WD	16-16-16-36	1.35V	•	•	
AVEXIR	AVD4U32001604G-4BZ1	16GB(4GB*4)	SS	SK Hynix	H5AN4G8NMFR	16-18-18-36	1.35V		•	
AVEXIR	AVD4U32001604G-4CIR	16GB(4GB*4)	SS			16-18-18-36	1.35V		•	
CORSAIR	CMD16GX4M4A3200C16	16GB(4GB*4)	SS			16-18-18-36	1.35V		•	
GEIL	GPR416GB3200C15QC	16GB(4GB*4)	SS			15-15-15-35	1.35V		•	
Kingston	HX432C16PB2K4/16	16GB(4GB*4)	SS			16-16-16-39	1.35V		•	
Panram	PUD43200C164G4NJW	16GB(4GB*4)	SS			16-18-18-39	1.35V		•	

(continued on the next page)

DDR4 3000 (O.C.) MHz capability

Vendors	Part No.	Size	SS/DS	Chip Brand	Chip NO.	Timing	Voltage	DIMM socket support (Optional)		
								1	2	4
G.SKILL	F4-3000C15Q-16GRR	16GB(4GB*4)	SS	Samsung	K4A4G085WD	15-15-15-35	1.35V	•	•	
G.SKILL	F4-3000C15Q-16GRB	16GB(4GB*4)	SS	Samsung	K4A4G085WD	15-15-15-35	1.35V	•	•	
G.SKILL	F4-3000C15Q-16GRK	16GB(4GB*4)	SS	Samsung	K4A4G085WD	15-15-15-35	1.35V	•	•	
G.SKILL	F4-3000C15Q2-32GRK	32GB(4GB*8)	SS	Samsung	K4A4G085WD	15-15-15-35	1.35V	•	•	
G.SKILL	F4-3000C15D-8GTZ	8GB(4GB*2)	SS	Samsung	K4A4G085WD	15-15-15-35	1.35V	•	•	
AVEXIR	AVD4U30001604G-4CI	16GB(4GB*4)	SS	SK hynix	H5AN4G8NMFR	16-18-18-36	1.35V	•	•	
AVEXIR	AVD4U30001504G-4BZ1	16GB(4GB*4)	SS	SK hynix	H5AN4G8NMFR	15-15-15-35	1.35V	•	•	
Kingston	HX430C15PB2K4/16	16GB(4GB*4)	SS			15-16-16-39	1.35V	•	•	
CORSAIR	CMD16GX4M4B3000C15	16GB(4GB*4)	SS	Samsung	K4A4G085WD	15-17-17-35	1.35V	•	•	
CORSAIR	CMK16GX4M4B3000C15	16GB(4GB*4)	SS	Samsung	K4A4G085WD	15-17-17-35	1.35V	•	•	
Panram	PUD43000C154G4NJW	16GB(4GB*4)	SS			15-17-17-35	1.35V	•	•	

DDR4 2800 (O.C.) MHz capability

Vendors	Part No.	Size	SS/DS	Chip Brand	Chip NO.	Timing	Voltage	DIMM socket support (Optional)		
								1	2	4
ADATA	AX4U2800W4G17	32GB (4GB*8)	DS	-	-	17-17-17-36	1.2	•	•	•
ADATA	AX4U2800W8G17	8GB	DS	-	-	15-15-15-36	1.2	•	•	•
Apacer	78.BAGM8.AF20B(XMP)	4GB	SS	-	-	17-17-17-36	-	•	•	•
Apacer	78.CAGM8.AF30B(XMP)	8GB	DS	-	-	17-17-17-36	-	•	•	•
AVEXIR	AVD4U28001504G-4CIR(XMP)	4GB	SS	-	-	15-15-15-35	1.35	•	•	•
AVEXIR	AVD4U28001608G-4CIR(XMP)	32GB (4GB*8)	DS	-	-	16-16-16-36	1.2	•	•	
CORSAIR	CMD16GX4M4A2800C16(Ver4.23)(XMP)	16GB (4GB*4)	SS	-	-	16-18-18-36	1.2	•	•	•
CORSAIR	CMD16GX4M4A2800C16(Ver5.29)	16GB (4GB*4)	SS	-	-	16-18-18-36	1.2	•	•	•
CORSAIR	CMD32GX4M4A2800C16(Ver5.29)(XMP)	32GB (8GB*4)	DS	-	-	18-18-18-36	1.2	•	•	•
CORSAIR	CMK16GX4M4A2800C16(Ver4.23)(XMP)	16GB (4GB*4)	SS	-	-	16-16-18-36	1.2	•	•	•
CORSAIR	CMK16GX4M4A2800C16(Ver5.29)	16GB (4GB*4)	SS	-	-	16-18-18-36	1.2	•	•	•
CORSAIR	CMK32GX4M4A2800C16(Ver5.29)(XMP)	32GB (8GB*4)	DS	-	-	16-18-18-36	1.2	•	•	•
G.SKILL	F4-2800C15Q2-64GRK(XMP)	64GB (8GB*8)	DS	-	-	15-16-16-35	1.25	•	•	•
G.SKILL	F4-2800C16Q-16GRR(XMP)	16GB (4GB*4)	SS	-	-	16-16-16-36	1.2	•	•	•
G.SKILL	F4-2800C16Q-32GRR(XMP)	32GB (8GB*4)	DS	-	-	16-16-16-36	1.2	•	•	•
Kingston	HX428C14PBK4/16(XMP)	16GB (4GB*4)	SS	-	-	14-15-15-40	1.35	•	•	•
Panram	PUD42800C164G4NJW(XMP)	16GB (4GB*4)	SS	-	-	16-18-18-36	1.25	•	•	•

(continued on the next page)

DDR4 2666 (O.C.) MHz capability

Vendors	Part No.	Size	SS/ DS	Chip Brand	Chip NO.	Timing	Voltage	DIMM socket support (Optional)		
								1	2	4
AVEXIR	AVD4U26661504G-4CIR (XMP)	4GB	SS	-	-	15-15-15-35	1.2	•	•	•
AVEXIR	AVD4U26661608G-4CIR (XMP)	32GB (4GB*8)	DS	-	-	16-16-16-36	1.2	•	•	•
CORSAIR	CMD128GX4M8A2666C15 (Ver4.31)(XMP)	128GB (8GB*16)	DS	-	-	15-17-17-35	1.2	•	•	•
CORSAIR	CMD16GX4M4A2666C15 (Ver4.23)(XMP)	16GB (4GB*4)	SS	-	-	15-17-17-35	1.2	•	•	•
CORSAIR	CMD16GX4M4A2666C16 (Ver4.23)(XMP)	16GB (4GB*4)	SS	-	-	16-18-18-35	1.2	•	•	•
CORSAIR	CMD16GX4M4A2666C16 (Ver5.29)(XMP)	16GB (4GB*4)	SS	-	-	16-18-18-35	1.2	•	•	•
CORSAIR	CMD32GX4M4A2666C15 (Ver4.23)(XMP)	32GB (8GB*4)	DS	-	-	15-17-17-35	1.2	•	•	•
CORSAIR	CMD32GX4M4A2666C15 (Ver5.29)	32GB (8GB*4)	DS	-	-	15-17-17-35	1.2	•	•	•
CORSAIR	CMD32GX4M4A2666C16 (Ver4.23)(XMP)	32GB (8GB*4)	DS	-	-	16-18-18-35	1.2	•	•	•
CORSAIR	CMK16GX4M4A2666C15 (Ver4.23)(XMP)	16GB (4GB*4)	SS	-	-	15-17-17-35	1.2	•	•	•
CORSAIR	CMK16GX4M4A2666C15 (Ver5.29)	16GB (4GB*4)	SS	-	-	15-17-17-35	1.2	•	•	•
CORSAIR	CMK16GX4M4A2666C16 (Ver4.23)(XMP)	16GB (4GB*4)	SS	-	-	16-18-18-35	1.2	•	•	•
CORSAIR	CMK16GX4M4A2666C16 (Ver5.29)(XMP)	16GB (4GB*4)	SS	-	-	16-18-18-35	1.2	•	•	•
CORSAIR	CMK32GX4M4A2666C15 (Ver4.23)(XMP)	32GB (8GB*4)	DS	-	-	15-17-17-35	1.2	•	•	•
CORSAIR	CMK32GX4M4A2666C15 (Ver5.29)(XMP)	32GB (8GB*4)	DS	-	-	15-17-17-35	1.2	•	•	•
CORSAIR	CMK32GX4M4A2666C16 (Ver4.23)(XMP)	32GB (8GB*4)	DS	-	-	16-16-18-35	1.2	•	•	•
CORSAIR	CMK32GX4M4A2666C16R (Ver4.23)(XMP)	32GB (8GB*4)	DS	-	-	16-18-18-35	1.2	•	•	•
G.SKILL	F4-2666C15Q-16GRRR (XMP)	16GB (4GB*4)	SS	-	-	15-15-15-35	1.2	•	•	•
G.SKILL	F4-2666C15Q-32GRRR (XMP)	32GB (8GB*4)	DS	-	-	15-15-15-35	1.2	•	•	•
G.SKILL	F4-2666C16Q2-64GRB (XMP)	64GB (8GB*8)	DS	-	-	16-16-16-36	1.2	•	•	•
KLEVV	IMA41GU6MFR8N-CF0 (XMP)	8GB	DS	ISDT	I5AN4G8NMFR	15-15-15-35	1.2	•	•	•
KLEVV	IMA451U6MFR8N-CF0 (XMP)	4GB	SS	ISDT	I5AN4G8NMFR	15-15-15-35	1.2	•	•	•
Team	TCD44G2666C15ABK (XMP)	4GB	SS	Samsung	K4A4G085WD	15-15-15-35	1.2	•	•	•
Team	TCD48G2666C15ABK (XMP)	32GB (8GB*4)	DS	Team	TCD48G2666C15ABK	15-15-15-35	1.2	•	•	•

(continued on the next page)

DDR4 2400 (O.C.) MHz capability

Vendors	Part No.	Size	SS/ DS	Chip Brand	Chip NO.	Timing	Voltage	DIMM socket support (Optional)			
								1	2	4	
AVEXIR	AVD4U24001604G-4CIR(XMP)	4GB	SS	-	-	16-16-16-36	1.2	•	•	•	•
AVEXIR	AVD4U24001608G-4M	32GB (4GB*8)	DS	SK Hynix	H5AN4G8NMFRFTFC	16-16-16-39	1.2	•	•	•	•
AVEXIR	AVD4U24001608G-4M(XMP)	32GB (4GB*8)	DS	SK Hynix	H5AN4G8NMFRFTFC	16-16-16-36	1.2	•	•	•	•
CORSAIR	CMD16GX4M4A2400C14 (Ver4.23)(XMP)	16GB (4GB*4)	SS	-	-	14-16-16-31	1.2	•	•	•	•
CORSAIR	CMD32GX4M4A2400C14 (Ver4.23)(XMP)	32GB (8GB*4)	DS	-	-	14-16-16-31	1.2	•	•	•	•
CORSAIR	CMK16GX4M4A2400C14 (Ver4.23)(XMP)	16GB (4GB*4)	SS	-	-	14-16-16-31	1.2	•	•	•	•
CORSAIR	CMK32GX4M4A2400C14 (Ver4.23)(XMP)	32GB (8GB*4)	DS	-	-	14-16-16-31	1.2	•	•	•	•
Crucial	BLS4G4D240FSA.8FAD	4GB	SS	-	-	16-16-16-40	1.2	•	•	•	•
crucial	BLS4G4D240FSA.8FAR(XMP)	4GB	SS	-	-	17-16-16-39	1.2	•	•	•	•
Crucial	BLS8G4D240FSA.16FAD	8GB	DS	-	-	16-16-16-40	1.2	•	•	•	•
crucial	BLS8G4D240FSA.16FAR(XMP)	8GB	DS	-	-	17-16-16-39	1.2	•	•	•	•
G.SKILL	F4-2400C15Q-16GRR	16GB (4GB*4)	SS	-	-	15-15-15-35	1.2	•	•	•	•
G.SKILL	F4-2400C15Q2-128GRK(XMP)	128GB (16GB*8)	DS	-	-	15-15-15-35	1.2	•	•	•	•
G.SKILL	F4-2400C15Q-32GRR	32GB (8GB*4)	DS	-	-	15-15-15-35	1.2	•	•	•	•
Kingston	HX424C12PB2K4/16	16GB (4GB*4)	SS	-	-	15-15-15-36	1.2	•	•	•	•
Panram	PUD42400C154G4NJW	16GB (4GB*4)	SS	-	-	15-15-15-35	1.2	•	•	•	•
Panram	PUD42400C158G4NJW	32GB (8GB*4)	DS	-	-	15-15-15-35	1.2	•	•	•	•
Team	TED44GM2400C16BK	4GB	SS	Samsung	K4A4G085WD	16-16-16-39	1.2	•	•	•	•
Team	TED48GM2400C16BK	8GB	DS	Samsung	K4A4G085WD	16-16-16-39	1.2	•	•	•	•
V-color	TD4G8C17-UH	4GB	SS	V-color	DW3J0460HM	15-15-15-36	1.2	•	•	•	•

(continued on the next page)

DDR4 2133 MHz capability

Vendors	Part No.	Size	SS/DS	Chip Brand	Chip NO.	Timing	Voltage	DIMM socket support (Optional)			
								1	2	4	4
ADATA	AD4U2133W4G15-B	4GB	SS	SK Hynix	H5AN4G8NMFRTFC	15-15-15-36	-	•	•	•	•
ADATA	AD4U2133W8G15	8GB	DS	SK Hynix	H5AN4G8NMFRTFC	15-15-15-36	1.2	•	•	•	•
Apacer	78.B1GM3.AF00B	4GB	SS	SK Hynix	H5AN4G8NMFRTFC	15-15-15-36	1.2	•	•	•	•
Apacer	78.C1GM3.AF10B	8GB	DS	SK Hynix	H5AN4G8NMFRTFC	15-15-15-36	1.2	•	•	•	•
AVEXIR	AVD4U21331504G-4M	4GB	SS	AVEXIR	512X8DDR4	15-15-15-35	1.2	•	•	•	•
CENTURY	CD8G-D4U2133	8GB	DS	SK Hynix	H5AN4G8NMFRTFC	15-15-15-36	-	•	•	•	•
CORSAIR	CMK16GX4M4A2133C13 (Ver4.23)(XMP)	16GB (4GB*4)	SS	-	-	13-15-15-28	1.2	•	•	•	•
CORSAIR	CMK32GX4M4A2133C13 (Ver4.23)(XMP)	32GB (8GB*4)	DS	-	-	13-15-15-28	1.2	•	•	•	•
CORSAIR	CMK64GX4M8A2133C13 (Ver4.23)(XMP)	64GB (8GB*8)	DS	-	-	13-15-15-28	1.2	•	•	•	•
CORSAIR	CMV4GX4M1A2133C15	4GB	SS	-	-	15-15-15-36	1.2	•	•	•	•
CORSAIR	CMV8GX4M1A2133C15	8GB	DS	-	-	15-15-15-36	1.2	•	•	•	•
G.SKILL	F4-2133C15Q-16GRR	16GB (4GB*4)	SS	-	-	15-15-15-35	1.2	•	•	•	•
G.SKILL	F4-2133C15Q-32GRR	32GB (8GB*4)	DS	-	-	15-15-15-35	-	•	•	•	•
KLEVV	IMA41GU6MFR8N-TF0	8GB	DS	ISDT	I5AN4G8NMFR	15-15-15-35	1.2	•	•	•	•
KLEVV	IMA451U6MFR8N-TF0	4GB	SS	ISDT	I5AN4G8NMFR	15-15-15-35	1.2	•	•	•	•
Panram	PUD42133C134G4NJW	16GB (4GB*4)	SS	-	-	13-13-13-35	1.2	•	•	•	•
Panram	PUD42133C138G4NJW	32GB (8GB*4)	DS	-	-	13-13-13-35	1.2	•	•	•	•
Panram	PUD42133C154G2VS	8GB (4GB*2)	SS	SK Hynix	H5AN4GBNMFRTFC	15-15-15-36	1.2	•	•	•	•
panram	PUD42133C154GNJK	4GB	SS	-	-	15-15-15-36	1.2	•	•	•	•
Panram	PUD42133C158G2VS	16GB (8GB*2)	DS	SK Hynix	H5AN4GBNMFRTFC	15-15-15-36	1.2	•	•	•	•
panram	PUD42133C158GNJK	8GB	DS	-	-	15-15-15-36	1.2	•	•	•	•
Samsung	M378A1G43DB0-CPB	8GB	DS	Samsung	K4A4G085WD	15-15-15-36	-	•	•	•	•
SanMax	SMD-4G28HP-21P	4GB	SS	SK Hynix	H5AN4G8NMFRTFC	15-15-15-37	-	•	•	•	•
SanMax	SMD-8G28HP-21P	8GB	DS	SK Hynix	H5AN4G8NMFRTFC	15-15-15-37	-	•	•	•	•
SK Hynix	HMA82GU6MFR8N-TF	16GB	DS	SK Hynix	H5AN8G8NMFRTFC	15-15-15-36	-	•	•	•	•
SUPER TALENT	FBU2B008GM	8GB	DS	Micron	D9RGQ	15-15-15-36	1.2	•	•	•	•
Team	TED44GM2133C15ABK	4GB	SS	SK Hynix	H5AN4G8NMFRTFC	15-15-15-36	1.2	•	•	•	•
Transcend	TS1GLH64V1H	8GB	DS	Samsung	K4A4G085WD	15-15-15-37	-	•	•	•	•
Transcend	TS512MLH64V1H	4GB	SS	Samsung	K4A4G085WD	15-15-15-37	-	•	•	•	•
UMAX	84G44G93MC-210MCGALGF15	4GB	SS	Micron	D9RGQ	15-15-15-36	-	•	•	•	•
UMAX	84G48G93MC-210MCGNGF15	8GB	DS	Micron	D9RGQ	15-15-15-36	-	•	•	•	•

1.4.3 DIMM installation

1

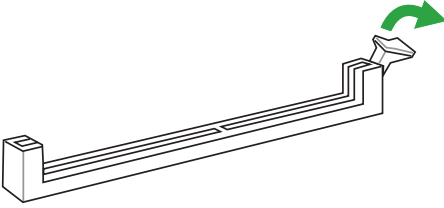

2

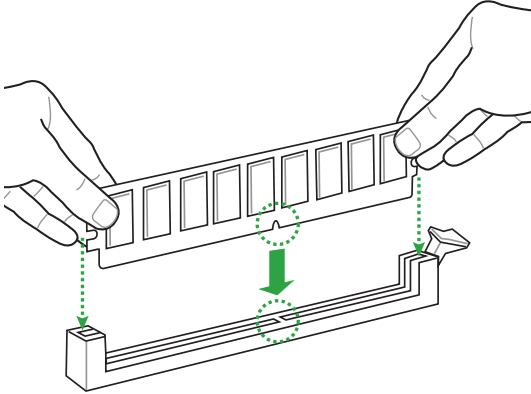

3

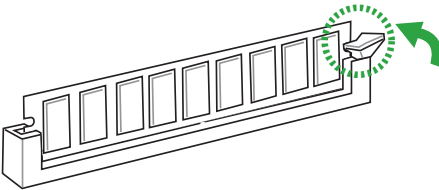

To remove a DIMM

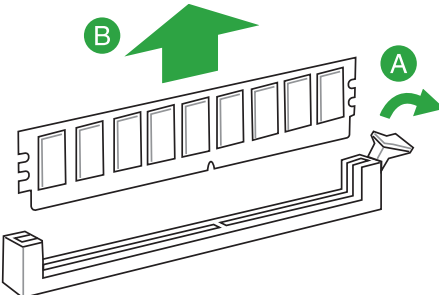

1.5 Expansion slots

In the future, you may need to install expansion cards. The following sub-sections describe the slots and the expansion cards that they support.



Unplug the power cord before adding or removing expansion cards. Failure to do so may cause you physical injury and damage motherboard components.

1.5.1 Installing an expansion card

To install an expansion card:

1. Before installing the expansion card, read the documentation that came with it and make the necessary hardware settings for the card.
2. Remove the system unit cover (if your motherboard is already installed in a chassis).
3. Remove the bracket opposite the slot that you intend to use. Keep the screw for later use.
4. Align the card connector with the slot and press firmly until the card is completely seated on the slot.
5. Secure the card to the chassis with the screw you removed earlier.
6. Replace the system cover.

1.5.2 Configuring an expansion card

After installing the expansion card, configure it by adjusting the software settings:

1. Turn on the system and change the necessary BIOS settings, if any. See Chapter 2 for information on BIOS setup.
2. Install the software drivers for the expansion card.

1.5.3 PCI Express 3.0 / 2.0 x1 slots

This motherboard supports PCI Express x1 network cards, SCSI cards, and other cards that comply with the PCI Express specifications.

1.5.4 PCI Express 3.0 / 2.0 x16 slots

This motherboard supports PCI Express x16 network cards, SCSI cards, and other cards that comply with the PCI Express specifications.

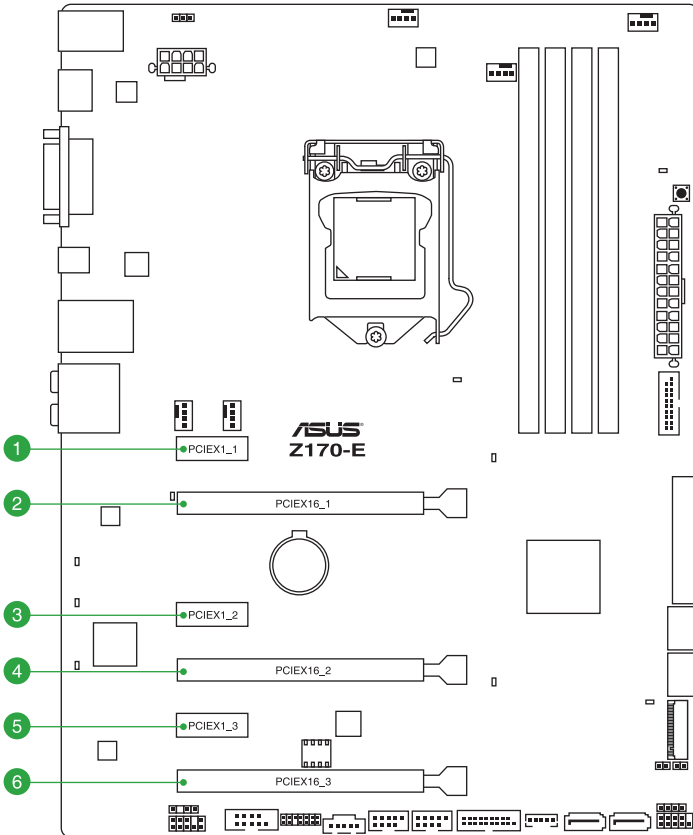

Slot No.	Expansion slot
1	PCIe 3.0/2.0 x1_1 slot
2	PCIe 3.0/2.0 x16_1 slot
3	PCIe 3.0/2.0 x1_2 slot
4	PCIe 3.0/2.0 x16_2 slot
5	PCIe 3.0/2.0 x1_3 slot
6	PCIe 3.0/2.0 x16_3 slot

VGA configuration	PCI Express 3.0 operating mode	
	PCIe 3.0/2.0 x16_1	PCIe 3.0/2.0 x16_2
Single VGA/PCIe card	x16 (single VGA recommended)	N/A
Dual VGA/PCIe card	x8	x8



- We recommend that you provide sufficient power when running CrossFireX™ or SLI™ mode.
- Connect a chassis fan to the motherboard connector labeled CHA_FAN1-2 when using multiple graphics cards for better thermal environment.

IRQ assignments for this motherboard

	A	B	C	D
PCIe x16_1	Shared	–	–	–
PCIe x16_2	Shared	–	–	–
PCIe x16_3	Shared	–	–	–
PCIe x1_1	–	Shared	–	–
PCIe x1_2	–	–	Shared	–
PCIe x1_3	–	–	–	Shared
SMBUS Controller	Shared	–	–	–
Intel SATA Controller	Shared	–	–	–
Intel LAN	Shared	–	–	–
Intel xHCI	Shared	–	–	–
HD Audio	Shared	–	–	–
ASMedia USB 3.1 Controller	Shared	–	–	–
M.2	Shared	–	–	–
SATA6G_3	–	–	Shared	–
SATA6G_4	–	–	–	Shared
SATA6G_5	–	–	Shared	–
SATA6G_6	–	–	–	Shared

1.6 Jumpers

1. Clear RTC RAM (2-pin CLRTC)

This jumper allows you to clear the Real Time Clock (RTC) RAM in CMOS. You can clear the CMOS memory of date, time, and system setup parameters by erasing the CMOS RTC RAM data. The onboard button cell battery powers the RAM data in CMOS, which include system setup information such as system passwords.

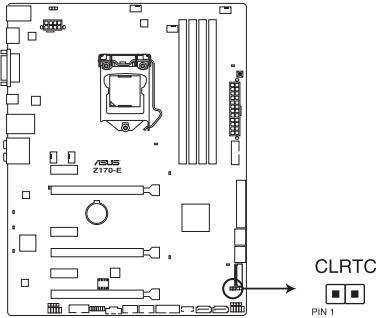

Z170-E Clear RTC RAM

To erase the RTC RAM:

1. Turn OFF the computer and unplug the power cord.
2. Short-circuit pin 1-2 with a metal object or jumper cap for about 5-10 seconds.
3. Plug the power cord and turn ON the computer.
4. Hold down the key during the boot process and enter BIOS setup to re-enter data.



Except when clearing the RTC RAM, never short-circuit the CLRTC jumper. Shorting the CLRTC jumper will cause system boot failure!



- If the steps above do not help, remove the onboard battery and move the jumper again to clear the CMOS RTC RAM data. After clearing the CMOS, reinstall the battery.
 - You do not need to clear the RTC when the system hangs due to overclocking. For system failure due to overclocking, use the CPU Parameter Recall (C.P.R.) feature. Shut down and reboot the system, then the BIOS automatically resets parameter settings to default values.
 - Due to chipset behavior, AC power off is required to enable C.P.R. function. You must turn off and on the power supply or unplug and plug the power cord before rebooting the system.
-

2. CPU Over Voltage jumper (3-pin CPU_OV)

The CPU Over Voltage jumper allows you to set a higher CPU voltage for a flexible overclocking system, depending on the type of the installed CPU. To gain more CPU voltage setting, insert the jumper to pins 2-3. To go back to its default CPU voltage setting, insert the jumper to pins 1-2.

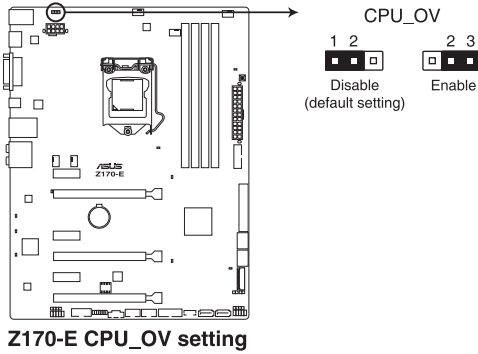

1.7 Connectors

1.7.1 Rear panel connectors

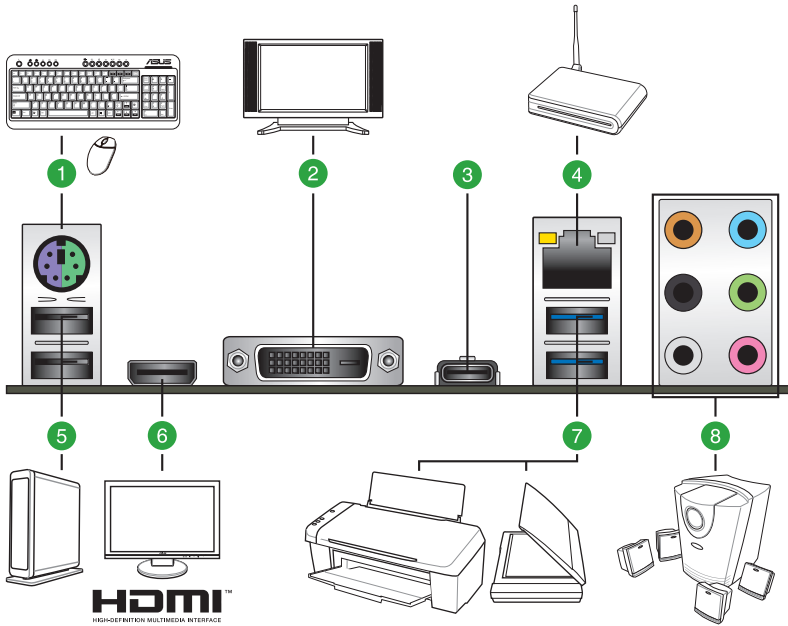

Rear panel connectors	
1. PS/2 keyboard/mouse port	5. USB 2.0 ports 910
2. DVI-D port	6. HDMI port
3. USB Type-C port (supports USB 3.1 Boost)	7. USB 3.0 ports 56 (supports USB 3.1 Boost)
4. LAN port*	8. Audio I/O ports**

* and **: Refer to the tables on the next page for LAN port LEDs and audio port definitions.



- The plugged USB 3.0 device will run on xHCI mode.
- USB 3.0 devices can only be used for data storage.
- We strongly recommend that you connect USB 3.0 devices to USB 3.0 ports for faster and better performance from your USB 3.0 devices.
- Due to the design of the Intel® chipset, all USB devices connected to the USB 2.0 and USB 3.0 ports are controlled by the xHCI controller. Some legacy USB devices must update their firmware for better compatibility.
- Multi-VGA output supports up to three displays under Windows® OS environment, two displays under BIOS, and one display under DOS.
- Intel display architecture design supports the following maximum supported pixel clocks (Pixel Clock = H total x V Total x Frame Rate (Screen refresh rate):
 - DVI port: 148 MHz
 - HDMI port: 300 MHz

* LAN ports LED indications

Activity Link LED		Speed LED	
Status	Description	Status	Description
Off	No link	Off	10 Mbps connection
Orange	Linked	Orange	100 Mbps connection
Orange (Blinking)	Data activity	Green	1 Gbps connection
Orange (Blinking then steady)	Ready to wake up from S5 mode		

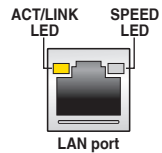

** Audio 2.1, 4.1, 5.1, or 7.1-channel configuration

Port	Headset 2.1-channel	4.1-channel	5.1-channel	7.1-channel
Light Blue	Line In	Line In	Line In	Side Speaker Out
Lime	Line Out	Front Speaker Out	Front Speaker Out	Front Speaker Out
Pink	Mic In	Mic In	Mic In	Mic In
Orange	–	–	Center/Subwoofer	Center/Subwoofer
Gray	–	–	–	Side Speaker Out
Black	–	Rear Speaker Out	Rear Speaker Out	Rear Speaker Out

1.7.2 Internal connectors

1. Serial port connector (10-1 pin COM)

This connector is for a serial (COM) port. Connect the serial port module cable to this connector, then install the module to a slot opening at the back of the system chassis.

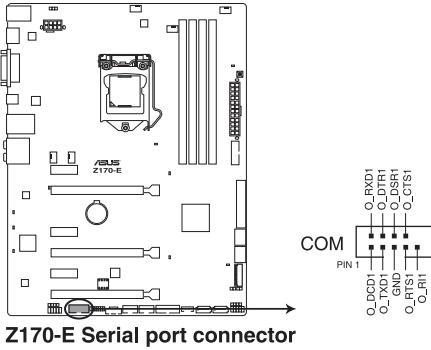

The COM module is purchased separately.

2. Intel® Z170 Serial ATA 6.0 Gb/s connectors (7-pin SATA6G_12, SATA6G_34, SATA6G_56, SATA Express)

These connectors connect to Serial ATA 6 Gb/s hard disk drives via Serial ATA 6 Gb/s signal cables. If you installed Serial ATA hard disk drives, you can create a RAID 0, 1, 5, and 10 configuration with the Intel® Rapid Storage Technology through the onboard Intel® Z170 chipset.

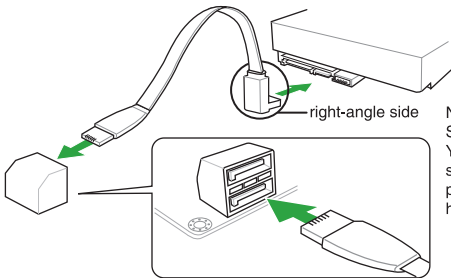
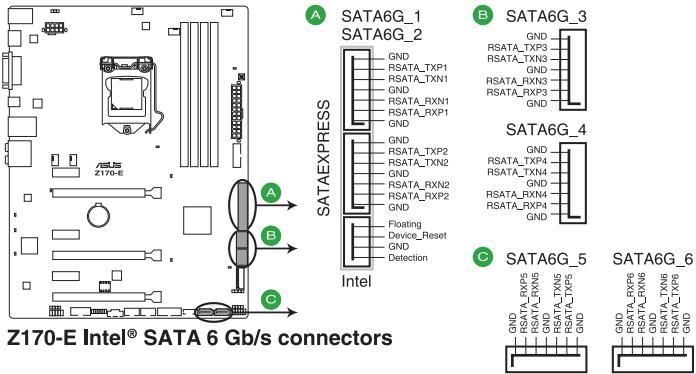

NOTE: Connect the right-angle side of SATA signal cable to SATA device. You may also connect the right-angle side of SATA cable to the onboard SATA port to avoid mechanical conflict with huge graphics cards.



These connectors are set to **[AHCI Mode]** by default. If you intend to create a Serial ATA RAID set using these connectors, set the SATA Mode item in the BIOS to **[RAID Mode]**. Refer to section 2.6.5 PCH Storage Configuration for details.



- The M.2 socket shares SATA ports with SATA Express. Only one SATA device could be activated. To use an M.2 SATA device, refer to section 2.6.8 Onboard Devices Configuration regarding the BIOS switch.
- The SATA EXPRESS connector can support one SATA Express device or two SATA devices.

3. CPU, water pump, CPU optional, extension, and chassis fan connectors (4-pin CPU_FAN; 4-pin W_PUMP; 4-pin CPU_OPT; 5-pin EXT_FAN; 4-pin CHA_FAN1-2)

Connect the fan cables to the fan connectors on the motherboard, ensuring that the black wire of each cable matches the ground pin of the connector.



- DO NOT forget to connect the fan cables to the fan connectors. Insufficient air flow inside the system may damage the motherboard components. These are not jumpers! Do not place jumper caps on the fan connectors! The CPU_FAN connector supports a CPU fan of maximum 1A (12W) fan power.
- Ensure that the CPU fan cable is securely installed to the CPU fan connector.

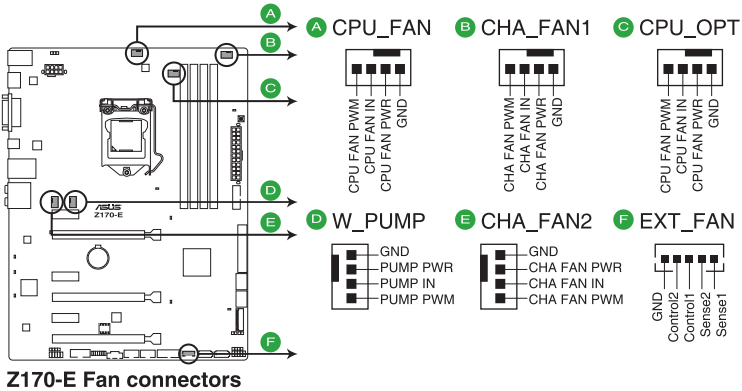

- The CPU_FAN connector supports the CPU fan of maximum 1A (12W) fan power.
- W_PUMP function support depends on water cooling device.
- The CPU_FAN connector and CHA_FAN connectors support the ASUS FAN Xpert 3 feature.
- The CPU fan connector detects the type of CPU fan installed and automatically switches the control modes. To configure the CPU fan's control mode, go to **Advanced Mode > Monitor > CPU Q-Fan Control** item in BIOS.
- The chassis fan connectors support DC and PWM modes. To set these fans to DC or PWM, go to **Advanced Mode > Monitor > Chassis Fan 1-2 Q-Fan Control** items in BIOS.



The FAN EXTENSION CARD is purchased separately.

4. ATX power connectors (24-pin EATXPWR, 8-pin EATX12V)

These connectors are for ATX power supply plugs. The power supply plugs are designed to fit these connectors in only one orientation. Find the proper orientation and push down firmly until the connectors completely fit.

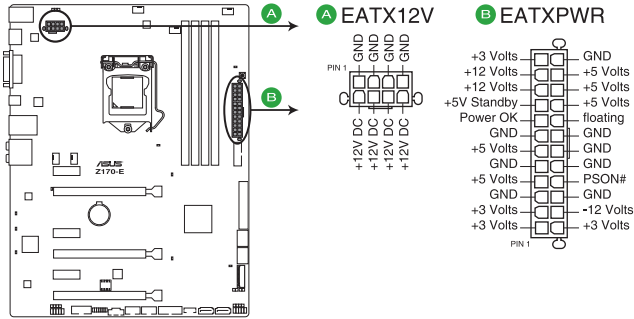

Z170-E ATX power connectors



- For a fully configured system, we recommend that you use a power supply unit (PSU) that complies with ATX 12V Specification 2.0 (or later version) and provides a minimum power of 350W.
- DO NOT forget to connect the 4-pin/8-pin ATX +12V power plug. Otherwise, the system will not boot up.
- We recommend that you use a PSU with higher power output when configuring a system with more power-consuming devices or when you intend to install additional devices. The system may become unstable or may not boot up if the power is inadequate.
- If you want to use two or more high-end PCI Express x16 cards, use a PSU with 1000W power or above to ensure the system stability.
- If you are uncertain about the minimum power supply requirement for your system, refer to the Recommended Power Supply Wattage Calculator at <http://support.asus.com/PowerSupplyCalculator/PSCalculator.aspx?SLanguage=en-us> for details.

5. DirectKey connector (2-pin DRCT)

This connector is for the chassis-mounted button that supports the DirectKey function. Connect the button cable that supports DirectKey, from the chassis to this connector on the motherboard.

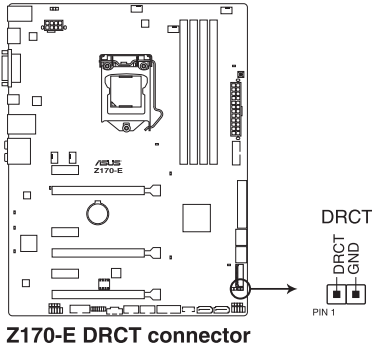

Ensure that your chassis comes with the extra button cable that supports the DirectKey feature. Refer to the technical documentation that came with the chassis for details.

6. Digital audio connector (4-1 pin SPDIF_OUT)

This connector is for an additional Sony/Philips Digital Interface (S/PDIF) port. Connect the S/PDIF Out module cable to this connector, then install the module to a slot opening at the back of the system chassis.

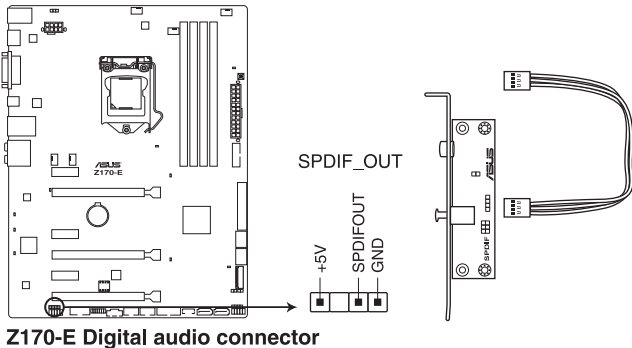

The S/PDIF module is purchased separately.

7. Front panel audio connector (10-1 pin AAFP)

This connector is for a chassis-mounted front panel audio I/O module that supports either HD Audio or legacy AC'97 audio standard. Connect one end of the front panel audio I/O module cable to this connector.

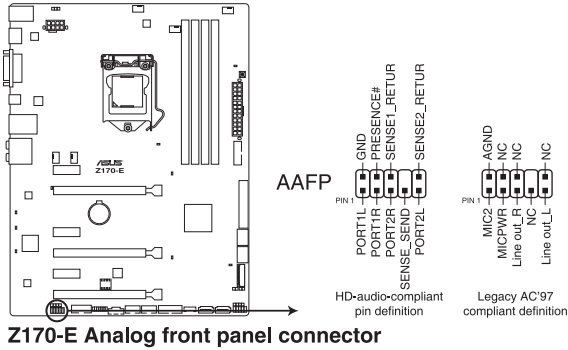

8. M.2 socket 3

This socket allows you to install an M.2 (NGFF) SSD module.

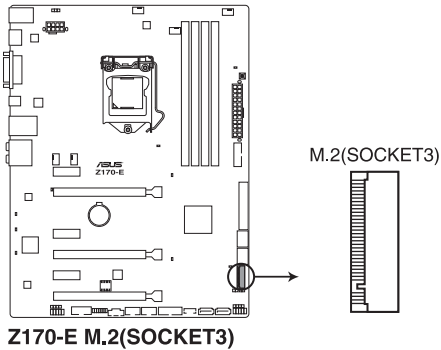

- This socket supports M Key and type 2242/2260/2280/22110 storage devices.
- The M.2 (NGFF) SSD module is purchased separately.
- The M.2 shares SATA mode with SATA Express. Change this item before installing M.2 SATA devices.

9. TPM connector (14-1 pin TPM)

This connector supports a Trusted Platform Module (TPM) system, which securely store keys, digital certificates, passwords and data. A TPM system also helps enhance network security, protects digital identities, and ensures platform integrity.

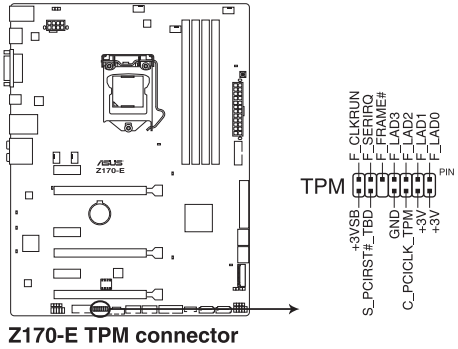

10. System warning speaker (4 pin SPEAKER)

This 4-pin connector is for the chassis-mounted system warning speaker. The speaker allows you to hear system beeps and warnings.

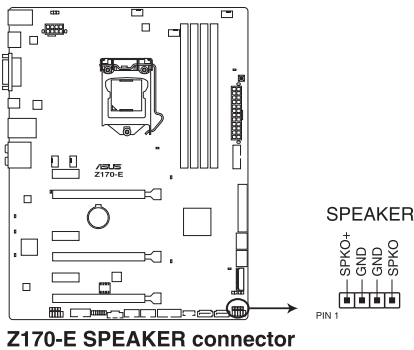

11. System panel connector (10-1 pin PANEL)

This connector supports several chassis-mounted functions.

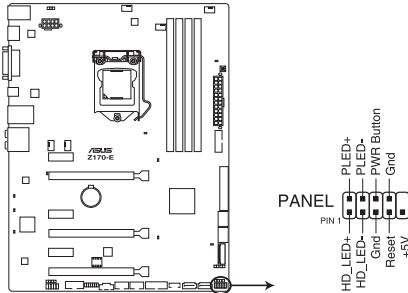

Z170-E PANEL connector

- **System power LED (2-pin or 3-pin PLED)**

The 2-pin or 3-pin connector is for the system power LED. Connect the chassis power LED cable to this connector. The system power LED lights up when you turn on the system power, and blinks when the system is in sleep mode.

- **Hard disk drive activity LED (2-pin HDLED)**

This 2-pin connector is for the HDD Activity LED. Connect the HDD Activity LED cable to this connector. The HDD LED lights up or flashes when data is read from or written to the HDD.

- **ATX power button/soft-off button (2-pin PWRBTN)**

This connector is for the system power button. Pressing the power button turns the system on or puts the system in sleep or soft-off mode depending on the operating system settings. Pressing the power switch for more than four seconds while the system is ON turns the system OFF.

- **Reset button (2-pin RESET)**

This 2-pin connector is for the chassis-mounted reset button for system reboot without turning off the system power.

12. USB 2.0 connectors (10-1 pin USB1112, USB1314)

These connectors are for USB 2.0 ports. Connect the USB module cable to any of these connectors, then install the module to a slot opening at the back of the system chassis. These USB connectors comply with USB 2.0 specifications and supports up to 480 Mb/s connection speed.

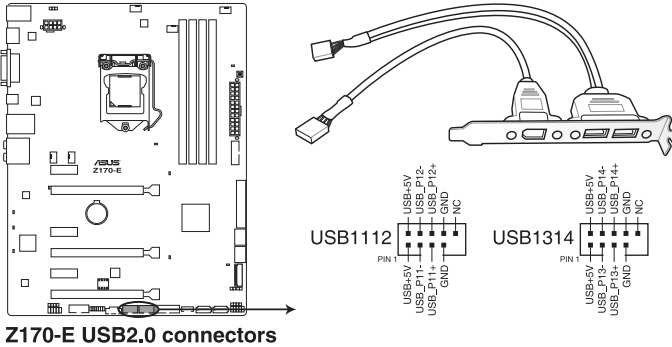

Never connect a 1394 cable to the USB connectors. Doing so will damage the motherboard!



The USB 2.0 module is purchased separately.



These connectors are based on xHCI specification. We recommend you to install the related driver to fully use the USB 2.0 ports under Windows® 7.

13. USB 3.0 connectors (20-1 pin USB3_12, USB3_34)

This connector allows you to connect a USB 3.0 module for additional USB 3.0 front or rear panel ports. With an installed USB 3.0 module, you can enjoy all the benefits of USB 3.0 including faster data transfer speeds of up to 5 Gb/s, faster charging time for USB-chargeable devices, optimized power efficiency, and backward compatibility with USB 2.0.

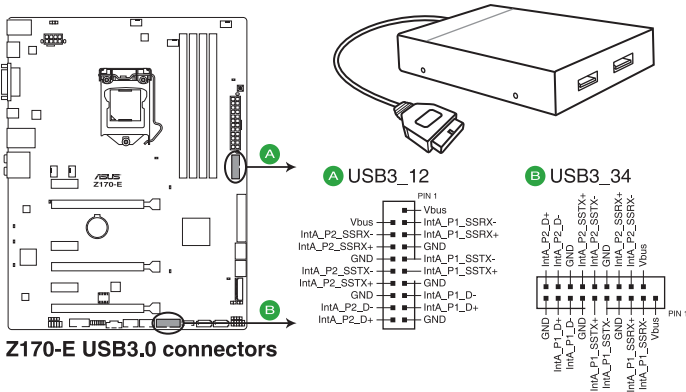

The USB 3.0 module is purchased separately.



- These connectors are based on xHCI specification. We recommend you to install the related driver to fully use the USB 3.0 ports under Windows® 7.
- The plugged USB 3.0 device will run on xHCI mode.
- These USB 3.0 ports support native UASP transfer standard in Windows® 10 / Windows® 8.1 / Windows® 8 and Turbo Mode when using USB 3.0 Boost feature.

14. Thunderbolt header (5-pin TB_HEADER)

This connector is for the add-on Thunderbolt I/O card that supports Intel's Thunderbolt Technology, allowing you to connect up to six Thunderbolt-enabled devices and a DisplayPort-enabled display in a daisy-chain configuration.

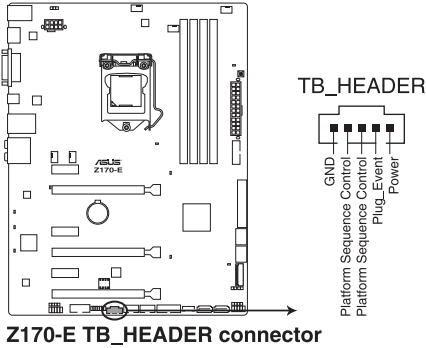

The add-on Thunderbolt I/O card and Thunderbolt cables are purchased separately.

1.8 Onboard LEDs

1. Standby Power LED

The motherboard comes with a standby power LED that lights up to indicate that the system is ON, in sleep mode, or in soft-off mode. This is a reminder that you should shut down the system and unplug the power cable before removing or plugging any motherboard components. The illustration below shows the location of the onboard LED.

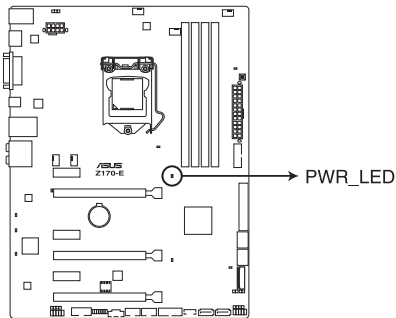

Z170-E PWR_LED

2. POST State LEDs

The POST State LEDs provide the status of these key components during POST (Power-On-Self Test): CPU, memory modules, VGA card, and hard disk drives. If an error is found, the critical component's LED stays lit up until the problem is solved.

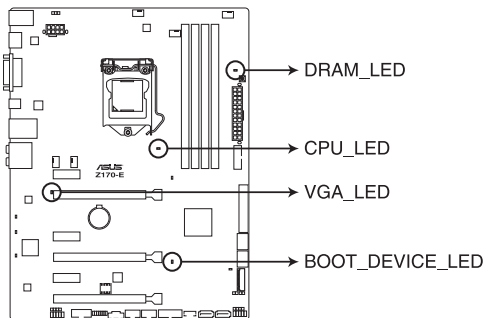

**Z170-E CPU/ DRAM/
BOOT_DEVICE/ VGA LED**

3. Audio LED Lighting

These LEDs light up when the system is fully powered and operating. To change the behavior of the LEDs to still mode or breathing mode, refer to BIOS section **2.6.8 Onboard Devices Configuration > Audio LED Lighting** for details.

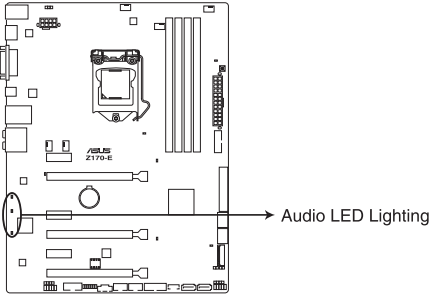

Z170-E Audio LED Lighting

1.9 Onboard buttons and switches

Onboard buttons and switches allow you to fine-tune performance when working on a bare or open-case system. This is ideal for overclockers and gamers who continually change settings to enhance system performance.

1. MemOK! button

Installing DIMMs that are not compatible with the motherboard may cause system boot failure. If the system fails to boot during POST stage and the DRAM_LED near the MemOK! button lights continuously, press the MemOK! button until the DRAM_LED starts blinking. System will begin automatic memory compatibility tuning and reboot for successful boot.

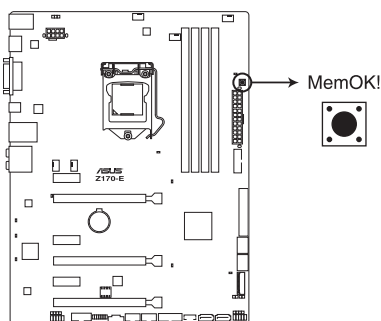

Z170-E MemOK! button



- Refer to section **1.8 Onboard LEDs** for the exact location of the DRAM_LED.
- The DRAM_LED also lights up when the DIMM is not properly installed. Turn off the system and reinstall the DIMM before using the MemOK! function.
- The MemOK! button does not function under Windows® OS environment.
- During the tuning process, the system loads and tests failsafe memory settings. It takes about 30 seconds for the system to test one set of failsafe settings. If the test fails, the system reboots and tests the next set of failsafe settings. The blinking speed of the DRAM_LED increases, indicating different test processes.
- Due to memory tuning requirement, the system automatically reboots when each timing set is tested. If the installed DIMMs still fail to boot after the whole tuning process, the DRAM_LED lights continuously. Replace the DIMMs with ones recommended in the Memory QVL (Qualified Vendors Lists) in this user manual or at www.asus.com.
- If you turn off the computer and replace DIMMs during the tuning process, the system continues memory tuning after turning on the computer. To stop memory tuning, turn off the computer and unplug the power cord for about 5–10 seconds.
- If your system fails to boot up due to BIOS overclocking, press the MemOK! button to boot and load the BIOS default settings. A message will appear during POST reminding you that the BIOS has been restored to its default settings.
- We recommend that you download and update to the latest BIOS version from www.asus.com after using the MemOK! function.

1.10 Software support

1.10.1 Installing an operating system

This motherboard supports Windows® 7 (64bit), Windows® 8 (64bit) and Windows® 10 (64bit) Operating Systems (OS). Always install the latest OS version and corresponding updates to maximize the features of your hardware.



Motherboard settings and hardware options vary. Refer to your OS documentation for detailed information.

1.10.2 Support DVD information

The Support DVD that comes with the motherboard package contains the drivers, software applications, and utilities that you can install to avail all motherboard features.



The contents of the Support DVD are subject to change at any time without notice. Visit the ASUS website at www.asus.com for updates.

Running the support DVD

Place the Support DVD into the optical drive. If Autorun is enabled in your computer, the DVD automatically displays the lists of the unique features of your ASUS motherboard. Click the **Drivers**, **Utilities**, **AHCI/RAID Driver**, **Manual**, **Contact**, or **Specials** tabs to display their respective menus.



The following screen is for reference only.

Shows the available device drivers if the system detects installed devices. Install the necessary drivers to use the devices

Click to display the applications and other software that the motherboard supports

Contains the list of supplementary user manuals. Click an item to open the folder of the user guide

Click to display product related information

Click to select an item to install

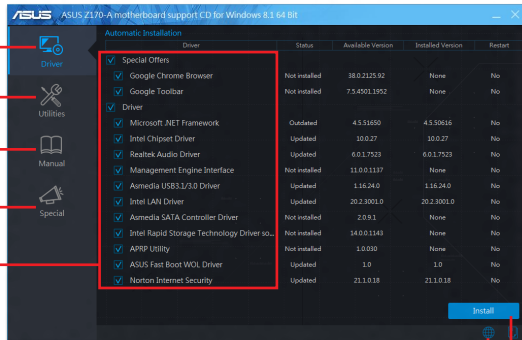

Click to display the ASUS contact information

Click to install the selected items



If Autorun is NOT enabled in your computer, browse the contents of the Support DVD to locate the file ASSETUP.EXE from the BIN folder. Double-click **ASSETUP.EXE** to run the DVD.

BIOS Setup

2

2.1 Knowing BIOS



The new ASUS UEFI BIOS is a Unified Extensible Interface that complies with UEFI architecture, offering a user-friendly interface that goes beyond the traditional keyboard-only BIOS controls to enable a more flexible and convenient mouse input. You can easily navigate the new UEFI BIOS with the same smoothness as your operating system. The term "BIOS" in this user manual refers to "UEFI BIOS" unless otherwise specified.

BIOS (Basic Input and Output System) stores system hardware settings such as storage device configuration, overclocking settings, advanced power management, and boot device configuration that are needed for system startup in the motherboard CMOS. In normal circumstances, the default BIOS settings apply to most conditions to ensure optimal performance. **DO NOT change the default BIOS settings** except in the following circumstances:

- An error message appears on the screen during the system bootup and requests you to run the BIOS Setup.
- You have installed a new system component that requires further BIOS settings or update.



Inappropriate BIOS settings may result to instability or boot failure. **We strongly recommend that you change the BIOS settings only with the help of a trained service personnel.**



When downloading or updating the BIOS file, rename it as **Z170E.CAP** for this motherboard.

2.2 BIOS setup program

Use the BIOS Setup to update the BIOS or configure its parameters. The BIOS screen include navigation keys and brief onscreen help to guide you in using the BIOS Setup program.

Entering BIOS at startup

To enter BIOS Setup at startup, press <Delete> during the Power-On Self Test (POST). If you do not press <Delete>, POST continues with its routines.

Entering BIOS Setup after POST

To enter BIOS Setup after POST:

- Press <Ctrl>+<Alt>+<Delete> simultaneously.
- Press the reset button on the system chassis.
- Press the power button to turn the system off then back on. Do this option only if you failed to enter BIOS Setup using the first two options.

After doing either of the three options, press <Delete> key to enter BIOS.



-
- The BIOS setup screens shown in this section are for reference purposes only, and may not exactly match what you see on your screen.
 - Ensure that a USB mouse is connected to your motherboard if you want to use the mouse to control the BIOS setup program.
 - If the system becomes unstable after changing any BIOS setting, load the default settings to ensure system compatibility and stability. Select the **Load Optimized Defaults** item under the **Exit** menu or press hotkey <F5>. See section 2.10 **Exit Menu** for details.
 - If the system fails to boot after changing any BIOS setting, try to clear the CMOS and reset the motherboard to the default value. See section 1.9 **Onboard buttons and switches** for information on how to erase the RTC RAM via the Clear CMOS button.
 - The BIOS setup program does not support the Bluetooth devices.
-

BIOS menu screen

The BIOS Setup program can be used under two modes: **EZ Mode** and **Advanced Mode**. You can change modes from the **Exit** menu or from the **Exit/Advanced Mode** screen.

2.2.1 EZ Mode

By default, the EZ Mode screen appears when you enter the BIOS setup program. The EZ Mode provides you an overview of the basic system information, and allows you to select the display language, system performance mode and boot device priority. To access the Advanced Mode, click **Exit/Advanced Mode**, then select **Advanced Mode** or press <F7> hotkey for the advanced BIOS settings.



The default screen for entering the BIOS setup program can be changed between EZ Mode or Advanced Mode. Refer to the Setup Mode item in section 2.8 **Boot menu** for details.

The screenshot shows the ASUS UEFI BIOS Utility - EZ Mode interface. The interface is dark-themed with blue and white text. It displays system information, CPU temperature, CPU core voltage, motherboard temperature, and system tuning options. A 'CPU FAN' graph is visible in the center, showing fan speed percentage over temperature. The bottom of the screen features navigation buttons: Default(F5), Save & Exit(F10), Advanced Mode(F7) with a right arrow, and Search on FAQ. A 'Boot Priority' section is also visible, showing a selected boot device: A030 ASUS ROG RAIDR EXPRESS PCIe SSD (244048MB).

Displays the system properties of the selected mode. Click < or > to switch EZ System Tuning modes

Displays the CPU/motherboard temperature, CPU voltage output, CPU/chassis/power fan speed, and SATA information

Selects the display language of the BIOS setup program

Creates storage RAID and configures system overclocking

Enables or disables the SATA RAID mode for Intel Rapid Storage Technology

Displays the CPU Fan's speed. Click the button to manually tune the fans

Loads optimized default settings

Saves the changes and resets the system

Click to go to Advanced mode

Search on the FAQ

Click to display boot devices

Selects the boot device priority



The boot device options vary depending on the devices you installed to the system.

2.2.2 Advanced Mode

The Advanced Mode provides advanced options for experienced end-users to configure the BIOS settings. The figure below shows an example of the Advanced Mode. Refer to the following sections for the detailed configurations.



To switch from EZ Mode to Advanced Mode, click **Advanced Mode** or press <F7> hotkey.

The screenshot shows the ASUS UEFI BIOS Utility in Advanced Mode. The interface is dark-themed with blue accents. At the top, there's a menu bar with options: My Favorites, Main, Ai Tweaker, Advanced, Monitor, Boot, Tool, and Exit. The 'Advanced' menu is currently selected. Below the menu bar, there are several configuration fields: Target CPU Turbo-Mode Frequency (2600MHz), Target DRAM Frequency (2133MHz), and Target Cache Frequency (2600MHz). The 'AI Overclock Tuner' is set to 'Manual'. Underneath, there are settings for BCLK Frequency (100.00), BCLK Amplitude (Auto), BCLK Slew Rate (Auto), BCLK Spread Spectrum (Auto), BCLK Frequency Slew Rate (Auto), ASUS MultiCore Enhancement (Auto), and CPU Core Ratio (Auto). A scroll bar is visible on the right side of the main configuration area. On the far right, there's a 'Hardware Monitor' panel showing CPU temperature (33°C), BCLK (100.0 MHz), Core Voltage (2.064 V), Ratio (22x), Memory (2133 MHz, 2.416 V, 4096 MB), and Voltage (+12V, +5V, +3.3V). At the bottom, there's a footer with 'Version 2.17.1246. Copyright (C) 2015 American Megatrends, Inc.' and a 'Last Modified' indicator. A 'Quick Note (F9)' icon is also present in the top right.

Configuration fields

Pop-up Menu

Menu bar Language MyFavorite(F3) Qfan Control(F6) EZ Tuning Wizard(F11) Scroll bar

Quick Note (F9)

Hot Keys

My Favorites **Main** **Ai Tweaker** **Advanced** **Monitor** **Boot** **Tool** **Exit**

Target CPU Turbo-Mode Frequency : 2600MHz
Target DRAM Frequency : 2133MHz
Target Cache Frequency : 2600MHz

AI Overclock Tuner Manual

BCLK Frequency 100.00

Initial BCLK Frequency Auto

BCLK Amplitude Auto

BCLK Slew Rate Auto

BCLK Spread Spectrum Auto

BCLK Frequency Slew Rate Auto

ASUS MultiCore Enhancement Auto

CPU Core Ratio Auto

[Manual]: When the manual mode is selected, the BCLK(base clock) frequency can be assigned manually.
[XMP]: When the XMP(extreme memory profile) mode is selected, the BCLK frequency and memory parameters will be optimized automatically.

Hardware Monitor

CPU

Frequency	Temperature
2200 MHz	33°C
BCLK	Core Voltage
100.0 MHz	2.064 V
Ratio	
22x	

Memory

Frequency	Voltage
2133 MHz	2.416 V
Capacity	
4096 MB	

Voltage

+12V	+5V
12.096 V	5.040 V
+3.3V	
3.344 V	

Version 2.17.1246. Copyright (C) 2015 American Megatrends, Inc.

Last Modified | EzMode(F7) |

Menu items **General help** **Last modified settings** **Go back to EZ Mode**

Sub-menu item **Displays the CPU temperature, CPU, and memory voltage output**

Menu bar

The menu bar on top of the screen has the following main items:

My Favorites	For saving the frequently-used system settings and configuration.
Main	For changing the basic system configuration
Ai Tweaker	For changing the overclocking settings
Advanced	For changing the advanced system settings
Monitor	For displaying the system temperature, power status, and changing the fan settings.
Boot	For changing the system boot configuration
Tool	For configuring options for special functions
Exit	For selecting the exit options and loading default settings

Menu items

The highlighted item on the menu bar displays the specific items for that menu. For example, selecting **Main** shows the Main menu items.

The other items (My Favorites, Ai Tweaker, Advanced, Monitor, Boot, Tool, and Exit) on the menu bar have their respective menu items.

Submenu items

A greater than sign (>) before each item on any menu screen means that the item has a submenu. To display the submenu, select the item and press <Enter>.

Language

This button above the menu bar contains the languages that you can select for your BIOS. Click this button to select the language that you want to display in your BIOS screen.

My Favorites (F3)

This button above the menu bar shows all BIOS items in a Tree Map setup. Select frequently-used BIOS settings and save it to MyFavorites menu.



Refer to section **2.3 My Favorites** for more information.

Q-Fan Control (F6)

This button above the menu bar displays the current settings of your fans. Use this button to manually tweak the fans to your desired settings.



Refer to section **2.2.3 QFan Control** for more information.

EZ Tuning Wizard (F11)

This button above the menu bar allows you to view and tweak the overclocking settings of your system. It also allows you to change the motherboard's SATA mode from AHCI to RAID mode.



Refer to section **2.2.4 EZ Tuning Wizard** for more information.

Search on FAQ

Move your mouse over this button to show a QR code, scan this QR code on your mobile device to connect to the BIOS FAQ web page of the ASUS support website. You can also scan the following QR code:



Quick Note (F9)

This button above the menu bar allows you to key in notes of the activities that you have done in BIOS.



-
- The Quick Note function does not support the following keyboard functions: delete, cut, copy, and paste.
 - You can only use the alphanumeric characters to enter your notes.
-

Hot keys

This button above the menu bar contains the navigation keys for the BIOS setup program. Use the navigation keys to select items in the menu and change the settings.

Scroll bar

A scroll bar appears on the right side of a menu screen when there are items that do not fit on the screen. Press the Up/Down arrow keys or <Page Up> / <Page Down> keys to display the other items on the screen.

General help

At the top right corner of the menu screen is a brief description of the selected item. Use <F12> key to capture the BIOS screen and save it to the removable storage device.

Configuration fields

These fields show the values for the menu items. If an item is user-configurable, you can change the value of the field opposite the item. You cannot select an item that is not user-configurable.

A configurable field is highlighted when selected. To change the value of a field, select it and press <Enter> to display a list of options.

Last Modified button

This button shows the items that you last modified and saved in BIOS Setup.

2.2.3 QFan Control

The QFan Control allows you to set a fan profile or manually configure the operating speed of your CPU and chassis fans.

The screenshot shows the ASUS Q-Fan Control interface in the BIOS. The title bar reads "ASUS UEFI BIOS Utility - EZ Mode". The top left shows the date "01/28/2016 Saturday" and time "23:20". The language is set to "English" and "EZ Tuning Wizard(F11)" is available. The main heading is "Q-Fan Control" with a sub-instruction: "Select your target fan and then move the slider to select any of these profiles: Standard, Silent, Turbo and Full Speed. You can also move the slider to Manual and manually configure the fan's operating speed."

Annotations with red lines point to various elements:

- Click to select a fan to be configured:** Points to the fan selection list on the left, which includes "Optimize All", "CPU FAN", "CHA1 FAN", "CHA2 FAN", "CHA3 FAN", "CHA4 FAN", "EXT FAN1", "EXT FAN2", and "EXT FAN3".
- Click to activate PWM Mode:** Points to the "PWM" button above the graph.
- Click to activate DC Mode:** Points to the "DC" button above the graph.
- Select a profile to apply to your fans:** Points to the "Standard" radio button in the profile selection row.
- Click to apply the fan setting:** Points to the "Apply" button.
- Click to undo the changes:** Points to the "Undo" button.
- Click to go back to main menu:** Points to the "Exit (ESC)" button.
- Select to manually configure your fans:** Points to the "Manual" radio button.

The graph shows fan speed (%) on the y-axis (0 to 100) and temperature (°C) on the x-axis (0 to 100). The profile is a curve that starts at ~20% at 0°C, rises to ~70% at 30°C, and reaches 100% at 70°C. Below the graph are radio buttons for "Standard", "Silent", "Turbo", "Full Speed", and "Manual". At the bottom are buttons for "Undo", "Apply", and "Exit (ESC)". The footer contains "Default(F5)", "Save & Exit(F10)", "Advanced Mode(F7)", and "Search on FAQ".

Configuring fans manually

Select **Manual** from the list of profiles to manually configure your fans' operating speed.

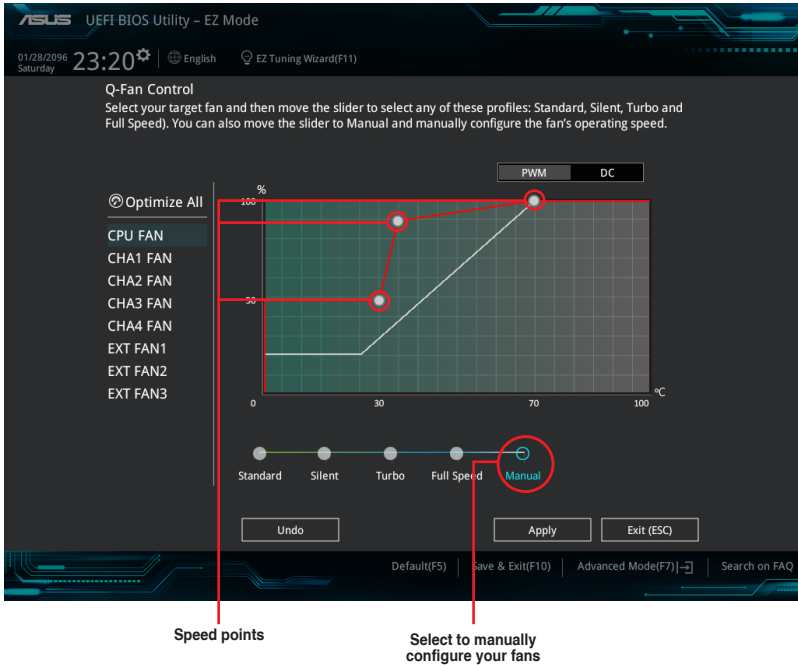

To configure your fans:

1. Select the fan that you want to configure and to view its current status.
2. Click and drag the speed points to adjust the fans' operating speed.
3. Click **Apply** to save the changes then click **Exit (ESC)**.

2.2.4 EZ Tuning Wizard

EZ Tuning Wizard allows you to easily overclock your CPU and DRAM, computer usage, and CPU fan to their best settings. You can also set RAID in your system using this feature.

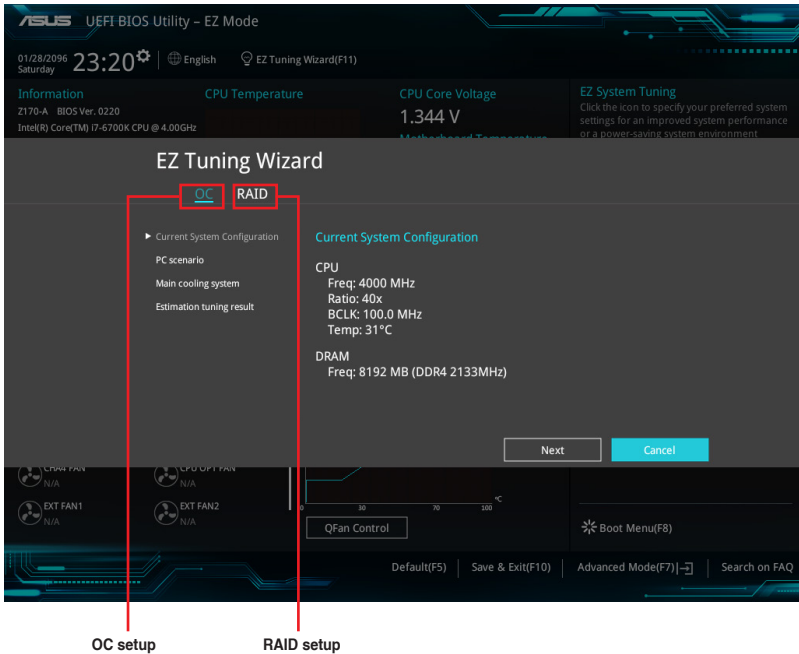

OC Tuning

To start OC Tuning:

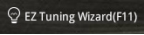
1. Press <F11> on your keyboard or click  from the BIOS screen to open EZ Tuning Wizard screen.
2. Click **OC** then click **Next**.
3. Select a PC scenario **Daily Computing** or **Gaming/Media Editing**, then click **Next**.

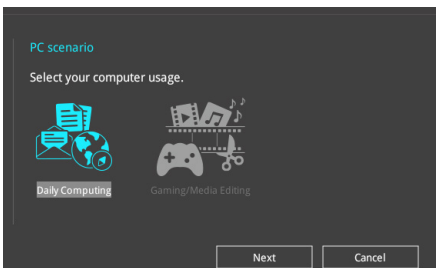

4. Select a Main Cooling System **BOX cooler**, **Tower cooler**, **Water cooler**, or **I'm not sure**, then click **Next**.

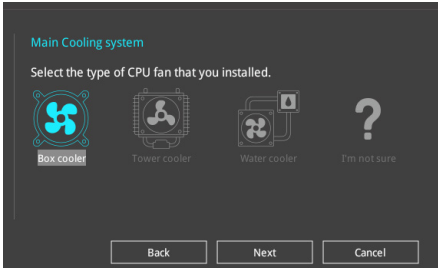

5. After selecting the Main Cooling System, click **Next** then click **Yes** to start the OC Tuning.

Creating RAID

To create RAID:

1. Press <F11> on your keyboard or click **EZ Tuning Wizard(F11)** from the BIOS screen to open EZ Tuning Wizard screen.
2. Click **RAID** then click **Next**.



- Ensure that your HDDs have no existing RAID volumes.
- Ensure to connect your HDDs to Intel® SATA connectors.

3. Select the port that you want to set to [RAID] mode, **PCIE** or **SATA**, then click **Next**.

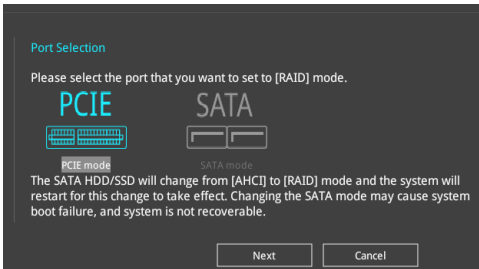

4. Select the type of storage for your RAID **Easy Backup** or **Super Speed**, then click **Next**.

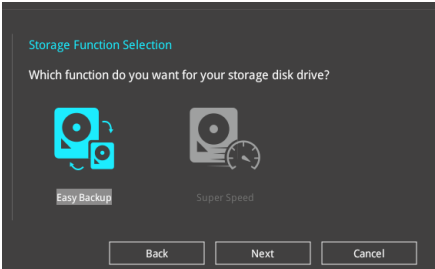

- a. For Easy Backup, click **Next** then select from **Easy Backup (RAID1)** or **Easy Backup (RAID10)**.

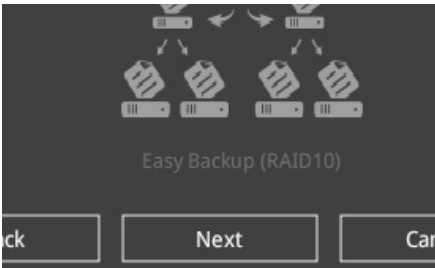

You can only select Easy Backup (RAID 10) if you connect four (4) HDDs.

- b. For Super Speed, click **Next** then select from **Super Speed (RAID0)** or **Super Speed (RAID5)**.

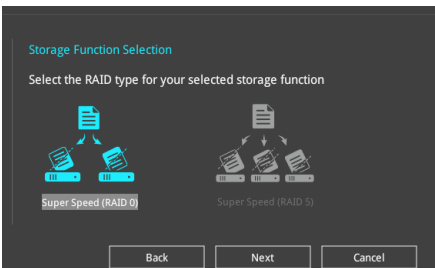

5. After selecting the type of RAID, click **Next** then click **Yes** to continue the RAID setup.
6. After the RAID setup is done, click **Yes** to exit the setup then click **OK** to reset your system.

2.3 My Favorites

My Favorites is your personal space where you can easily save and access your favorite BIOS items.





My Favorites comes with several performance, power saving, and fast boot related items by default. You can personalize this screen by adding or removing items.

Adding items to My Favorites

To add BIOS items:

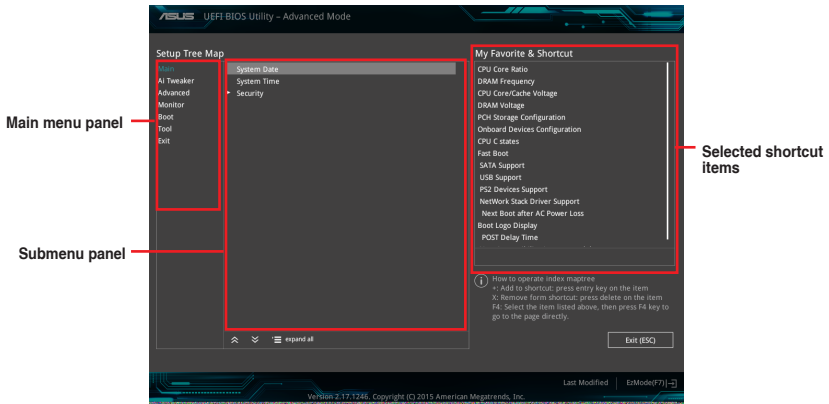
1. Press <F3> on your keyboard or click  (F3)MyFavorite from the BIOS screen to open Setup Tree Map screen.
2. On the Setup Tree Map screen, select the BIOS items that you want to save in My Favorites screen.



3. Select an item from main menu panel, then click the submenu that you want to save as favorite from the submenu panel and click  or press <Enter> on your keyboard.



You cannot add the following items to My Favorite items:

- Items with submenu options
- User-managed items such as language and boot order
- Configuration items such as Memory SPD Information, system time and date.

4. Click **Exit (ESC)** or press <Esc> key to close Setup Tree Map screen.
5. Go to My Favorites menu to view the saved BIOS items.

2.4 Main menu

The Main menu screen appears when you enter the Advanced Mode of the BIOS Setup program. The Main menu provides you an overview of the basic system information, and allows you to set the system date, time, language, and security settings.

The screenshot displays the 'Main' menu of the ASUS UEFI BIOS Utility in Advanced Mode. The top bar shows the date and time as 01/28/2016 Saturday, 23:22, along with various utility icons. The main menu is divided into several sections: 'BIOS Information' (BIOS Version: 0220 x64, Build Date: 06/08/2015, EC1 Version: MBEC-Z170-0408, EC2 Version, ME FW Version: 11.0.0.1136), 'Processor Information' (Brand String: Intel(R) Core(TM) i7-6700K CPU @ 4.00GHz, Frequency: 4000 MHz, Total Memory: 8192 MB, Memory Frequency: 2133 MHz), 'System Language' (English), 'System Date' (01/28/2016), and 'System Time' (23:22:05). A 'Hardware Monitor' panel on the right shows CPU (4000 MHz, 36°C), Memory (2133 MHz, 1.200 V), and Voltage (+12V, +5V, +3.3V, 3.392 V) data. A note at the bottom left says 'Choose the system default language'.

Security

The Security menu items allow you to change the system security settings.

The screenshot displays the 'MainSecurity' menu in the ASUS UEFI BIOS Utility. It provides instructions for setting passwords: 'If ONLY the Administrator's password is set, then this only limits access to Setup and is only asked for when entering Setup.' and 'If ONLY the User's password is set, then this is a power on password and must be entered to boot or enter Setup. In Setup the User will have Administrator rights. The password length must be in the following range: Minimum length: 3, Maximum length: 20. Administrator Password: Not Installed, User Password: Not Installed.' The 'Hardware Monitor' panel on the right shows CPU (2200 MHz, 33°C), Memory (2133 MHz, 2.416 V), and Voltage (+3.3V, 3.392 V) data.



- If you have forgotten your BIOS password, erase the CMOS Real Time Clock (RTC) RAM to clear the BIOS password. See section 1.9 Onboard buttons and switches for information on how to erase the RTC RAM via the Clear CMOS button.
- The Administrator or User Password items on top of the screen show the default **[Not Installed]**. After you set a password, these items show **[Installed]**.

Administrator Password

If you have set an administrator password, we recommend that you enter the administrator password for accessing the system. Otherwise, you might be able to see or change only selected fields in the BIOS setup program.

To set an administrator password:

1. Select the **Administrator Password** item and press <Enter>.
2. From the **Create New Password** box, key in a password, then press <Enter>.
3. Confirm the password when prompted.

To change an administrator password:

1. Select the **Administrator Password** item and press <Enter>.
2. From the **Enter Current Password** box, key in the current password, then press <Enter>.
3. From the **Create New Password** box, key in a new password, then press <Enter>.
4. Confirm the password when prompted.

To clear the administrator password, follow the same steps as in changing an administrator password, but press <Enter> when prompted to create/confirm the password. After you clear the password, the **Administrator Password** item on top of the screen shows **[Not Installed]**.

User Password

If you have set a user password, you must enter the user password for accessing the system. The User Password item on top of the screen shows the default **[Not Installed]**. After you set a password, this item shows **[Installed.]**

To set a user password:

1. Select the **User Password** item and press <Enter>.
2. From the **Create New Password** box, key in a password, then press <Enter>.
3. Confirm the password when prompted.

To change a user password:

1. Select the **User Password** item and press <Enter>.
2. From the **Enter Current Password** box, key in the current password, then press <Enter>.
3. From the **Create New Password** box, key in a new password, then press <Enter>.
4. Confirm the password when prompted.

To clear the user password, follow the same steps as in changing a user password, but press <Enter> when prompted to create/confirm the password. After you clear the password, the **User Password** item on top of the screen shows **[Not Installed]**.

2.5 Ai Tweaker menu

The Ai Tweaker menu items allow you to configure overclocking-related items.



Be cautious when changing the settings of the Ai Tweaker menu items. Incorrect field values can cause the system to malfunction.



The configuration options for this section vary depending on the CPU and DIMM model you installed on the motherboard.

Scroll down to display other BIOS items.

The screenshot shows the ASUS UEFI BIOS Utility in Advanced Mode, specifically the Ai Tweaker menu. The interface is dark-themed with blue and white text. At the top, it displays the date and time (02/19/2016, 06:22), language (English), and various utility shortcuts. The main menu includes My Favorites, Main, Ai Tweaker (selected), Advanced, Monitor, Boot, Tool, and Exit. The Ai Tweaker section lists several settings: Target CPU Turbo-Mode Frequency (2600MHz), Target DRAM Frequency (2133MHz), Target Cache Frequency (2600MHz), Ai Overdock Tuner (set to Auto), ASUS MultiCore Enhancement (Auto), CPU Core Ratio (Auto), BCLK Frequency (DRAM Frequency Ratio), DRAM Odd Ratio Mode (Enabled), DRAM Frequency (Auto), TPU (Keep Current Settings), EPU Power Saving Mode (Disabled), and CPU SVID Support (Auto). On the right side, there is a Hardware Monitor section showing CPU Frequency (2200 MHz), Temperature (33°C), BCLK (100.0 MHz), Core Voltage (2.064 V), Ratio (22x), Memory Frequency (2133 MHz), Voltage (2.416 V), Capacity (4096 MB), and Voltage (+1.2V, +5V, +3.3V, 3.344 V). At the bottom, it shows the last modified time and the EZ Mode (F7) key. The footer indicates the version (2.17.1246) and copyright (© 2015 American Megatrends, Inc.).

Ai Overclock Tuner [Auto]

This item allows you to select the CPU overclocking options to achieve the desired CPU internal frequency. Select any of these preset overclocking configuration options:

- [Auto] Loads the optimal settings for the system.
- [Manual] Automatically optimizes the CPU ratio and BCLK frequency.
- [XMP] If you install memory modules supporting the eXtreme Memory Profile (XMP) Technology, choose this item to set the profiles supported by your memory modules for optimizing the system performance.



The following item appears only when you set the Ai Overclocking Tuner to **[Manual]**.

BCLK Frequency [100.00]

This item allows you to set the BCLK (base clock) frequency to enhance the system performance. Use the <+> or <-> to adjust the value. The values range from 40.0 MHz to 500.0 MHz.



We recommend you to set the value based on the CPU specification, as high BCLK frequencies may damage the CPU permanently.

ASUS MultiCore Enhancement [Auto]

[Auto] This item allows you to maximize the overlocking performance optimized by ASUS core ratio settings.

[Disabled] This item allows you to set to default core ratio settings.

CPU Core Ratio [Auto]

This item allows you to set the CPU core ratio limit per core or synchronize automatically to all cores.

Configuration options: [Auto] [Sync All Cores] [Per Core]



When the CPU Core Ratio is set to **[Synch All Cores]**, the following item appears:

1-Core Ratio Limit [Auto]

Select **[Auto]** to apply the CPU default Turbo Ratio setting or manually assign a 1-Core Limit value that must be higher than or equal to the 2-Core Ratio Limit.



When the CPU Core Ratio is set to **[Per Core]**, the following item appears:

1-Core Ratio Limit [Auto]

Select **[Auto]** to apply the CPU default Turbo Ratio setting or manually assign a 1-Core Limit value that must be higher than or equal to the 2-Core Ratio Limit.

2-Core Ratio Limit [Auto]

Select **[Auto]** to apply the CPU default Turbo Ratio setting or manually assign a 2-Core Limit value that must be higher than or equal to the 3-Core Ratio Limit.

3-Core Ratio Limit [Auto]

Select **[Auto]** to apply the CPU default Turbo Ratio setting or manually assign a 3-Core Limit value that must be higher than or equal to the 4-Core Ratio Limit.

4-Core Ratio Limit [Auto]

Select **[Auto]** to apply the CPU default Turbo Ratio setting or manually assign a 4-Core Limit value that must be higher than or equal to the 3-Core Ratio Limit.



If you assign a value for more Core Ratio Limit, do not set the less Core Ratio Limit to **[Auto]**.

BCLK Frequency : DRAM Frequency Ratio [Auto]

This item allows you to change the BCLK frequency to DRAM frequency ratio.

Configuration options: [Auto] [100:133] [100:100]

DRAM Odd Ratio Mode [Enabled]

This item allows you to enable or disable the odd ratio mode for better granularity.

Configuration options: [Disabled] [Enabled]

DRAM Frequency [Auto]

This item allows you to set the memory operating frequency. The configurable options vary with the BCLK (base clock) frequency setting. Select the auto mode to apply the optimized setting.

Configuration options: [DDR4-2133MHz] [DDR4-2200MHz] [DDR4-2266MHz] [DDR4-2300MHz] [DDR4-2400MHz] [DDR4-2500MHz] [DDR4-2533MHz] [DDR4-2600MHz] [DDR4-2666MHz] [DDR4-2700MHz] [DDR4-2800MHz] [DDR4-2900MHz] [DDR4-2933MHz] [DDR4-3000MHz] [DDR4-3066MHz] [DDR4-3100MHz] [DDR4-3200MHz] [DDR4-3333MHz] [DDR4-3466MHz] [DDR4-3600MHz] [DDR4-3733MHz] [DDR4-3866MHz] [DDR4-4000MHz] [DDR4-4133MHz] [DDR4-4266MHz]

TPU [Keep Current Settings]

This item allows you to automatically overclock the CPU and DRAM frequencies and voltage for an enhanced system performance.

- [Keep Current Settings] Keep the current settings without changing anything.
- [TPU I] Applies air cooling overclocking conditions.
- [TPU II] Applies water cooling overclocking conditions.



Ensure to use water cooling device before selecting [TPU II].

EPU Power Saving Mode [Disabled]

The ASUS EPU (Energy Processing Unit) sets the CPU in its minimum power consumption settings.

Configuration options: [Disabled] [Enabled]

CPU SVID Support

Disable this item to stop the CPU from communicating with the external voltage regulator.

Configuration options: [Auto] [Disabled] [Enabled]

DRAM Timing Control

The subitems in this menu allow you to set the DRAM timing control features. Use the <+> or <-> keys to adjust the value. To restore the default setting, type [auto] using the keyboard and press the <Enter> key.



Changing the values in this menu may cause the system to become unstable! If this happens, revert to the default settings.

Primary Timings

DRAM CAS# Latency [Auto]

Configuration options: [Auto] [1] – [31]

DRAM RAS# to CAS# Delay [Auto]

Configuration options: [Auto] [1] – [31]

DRAM RAS# ACT Time [Auto]

Configuration options: [Auto] [1] – [63]

DRAM COMMAND Rate [Auto]

Configuration options: [Auto] [1] – [2]

Secondary Timings

DRAM RAS# to RAS# Delay L [Auto]

Configuration options: [Auto] [1] – [15]

DRAM RAS# to RAS# Delay S [Auto]

Configuration options: [Auto] [1] – [15]

DRAM REF Cycle Time [Auto]

Configuration options: [Auto] [1] – [1023]

DRAM Refresh Interval [Auto]

Configuration options: [Auto] [1] – [32767]

DRAM WRITE Recovery Time [Auto]

Configuration options: [Auto] [1] – [31]

DRAM READ to PRE Time [Auto]

Configuration options: [Auto] [1] – [15]

DRAM FOUR ACT WIN Time [Auto]

Configuration options: [Auto] [1] – [63]

DRAM WRITE to READ Delay [Auto]

Configuration options: [Auto] [1] – [15]

DRAM WRITE to READ Delay L [Auto]

Configuration options: [Auto] [1] – [15]

DRAM WRITE to READ Delay S [Auto]

Configuration options: [Auto] [1] – [15]

DRAM CKE Minimum Pulse Width [Auto]

Configuration options: [Auto] [1] – [15]

DRAM Write Latency [Auto]

Configuration options: [Auto] [1] – [31]

Skew Control

ODT RTT WR (CHA) [Auto]

Configuration options: [Auto] [0 DRAM CLOCK] [80 DRAM CLOCK] [120 DRAM CLOCK] [240 DRAM CLOCK] [255 DRAM CLOCK]

ODT RTT PARK (CHA) [Auto]

Configuration options: [Auto] [0 DRAM CLOCK] [34 DRAM CLOCK] [40 DRAM CLOCK] [48 DRAM CLOCK] [60 DRAM CLOCK] [80 DRAM CLOCK] [120 DRAM CLOCK] [240 DRAM CLOCK]

ODT RTT NOM (CHA) [Auto]

Configuration options: [Auto] [0 DRAM CLOCK] [34 DRAM CLOCK] [40 DRAM CLOCK] [48 DRAM CLOCK] [60 DRAM CLOCK] [80 DRAM CLOCK] [120 DRAM CLOCK] [240 DRAM CLOCK]

ODT RTT WR (CHB) [Auto]

Configuration options: [Auto] [0 DRAM CLOCK] [80 DRAM CLOCK] [120 DRAM CLOCK] [240 DRAM CLOCK] [255 DRAM CLOCK]

ODT RTT PARK (CHB) [Auto]

Configuration options: [Auto] [0 DRAM CLOCK] [34 DRAM CLOCK] [40 DRAM CLOCK] [48 DRAM CLOCK] [60 DRAM CLOCK] [80 DRAM CLOCK] [120 DRAM CLOCK] [240 DRAM CLOCK]

ODT RTT NOM (CHB) [Auto]

Configuration options: [Auto] [0 DRAM CLOCK] [34 DRAM CLOCK] [40 DRAM CLOCK] [48 DRAM CLOCK] [60 DRAM CLOCK] [80 DRAM CLOCK] [120 DRAM CLOCK] [240 DRAM CLOCK]

Data Rising Slope [Auto]

Configuration options: [Auto] [0] - [15]

Data Rising Slope Offset [Auto]

Configuration options: [Auto] [0] - [1]

CMD Rising Slope [Auto]

Configuration options: [Auto] [0] - [15]

CMD Rising Slope Offset [Auto]

Configuration options: [Auto] [0] - [1]

Ctl Rising Slope [Auto]

Configuration options: [Auto] [0] - [15]

Ctl Rising Slope Offset [Auto]

Configuration options: [Auto] [0] - [1]

Clk Rising Slope [Auto]

Configuration options: [Auto] [0] - [15]

Clk Rising Slope Offset [Auto]

Configuration options: [Auto] [0] - [1]

Data Falling Slope [Auto]

Configuration options: [Auto] [0] - [15]

Data Falling Slope Offset [Auto]

Configuration options: [Auto] [0] - [1]

CMD Falling Slope [Auto]

Configuration options: [Auto] [0] - [15]

CMD Falling Slope Offset [Auto]

Configuration options: [Auto] [0] - [1]

Ctl Falling Slope [Auto]

Configuration options: [Auto] [0] - [15]

Ctl Falling Slope Offset [Auto]

Configuration options: [Auto] [0] - [1]

Clk Falling Slope [Auto]

Configuration options: [Auto] [0] - [15]

Clk Falling Slope Offset [Auto]

Configuration options: [Auto] [0] - [1]

RTL IOL control

DRAM RTL INIT Value [Auto]

Configuration options: [Auto] [0] - [127]

DRAM RTL (CHA DIMM0 Rank0) [Auto]

Configuration options: [Auto] [0] - [127]

DRAM RTL (CHA DIMM0 Rank1) [Auto]

Configuration options: [Auto] [0] - [127]

DRAM RTL (CHA DIMM1 Rank0) [Auto]

Configuration options: [Auto] [0] - [127]

DRAM RTL (CHA DIMM1 Rank1) [Auto]

Configuration options: [Auto] [0] - [127]

DRAM RTL (CHB DIMM0 Rank0) [Auto]

Configuration options: [Auto] [0] - [127]

DRAM RTL (CHB DIMM0 Rank1) [Auto]

Configuration options: [Auto] [0] - [127]

DRAM RTL (CHB DIMM1 Rank0) [Auto]

Configuration options: [Auto] [0] - [127]

DRAM RTL (CHB DIMM1 Rank1) [Auto]

Configuration options: [Auto] [0] - [127]

DRAM IOL (CHA DIMM0 Rank0) [Auto]

Configuration options: [Auto] [0] - [15]

DRAM IOL (CHA DIMM0 Rank1) [Auto]

Configuration options: [Auto] [0] - [15]

DRAM IOL (CHA DIMM1 Rank0) [Auto]

Configuration options: [Auto] [0] - [15]

DRAM IOL (CHA DIMM1 Rank1) [Auto]

Configuration options: [Auto] [0] - [15]

DRAM IOL (CHB DIMM0 Rank0) [Auto]

Configuration options: [Auto] [0] - [15]

DRAM IOL (CHB DIMM0 Rank1) [Auto]

Configuration options: [Auto] [0] - [15]

DRAM IOL (CHB DIMM1 Rank0) [Auto]

Configuration options: [Auto] [0] - [15]

DRAM IOL (CHB DIMM1 Rank1) [Auto]

Configuration options: [Auto] [0] - [15]

IO Latency offset

CHA IO_Latency_offset

Configuration options: [Auto] [0] - [127]

CHB IO_Latency_offset

Configuration options: [Auto] [0] - [127]

IO Latency RFR delay

CHA RFR delay

Configuration options: [Auto] [0] - [127]

CHB RFR delay

Configuration options: [Auto] [0] - [127]

Third Timings

tRDRD_sg [Auto]

Configuration options: [Auto] [0] - [63]

tRDRD_dg [Auto]

Configuration options: [Auto] [0] - [63]

tRDWR_sg [Auto]

Configuration options: [Auto] [0] - [63]

tRDWR_dg [Auto]

Configuration options: [Auto] [0] - [63]

tWRWR_sg [Auto]

Configuration options: [Auto] [0] - [63]

tWRWR_dg [Auto]

Configuration options: [Auto] [0] - [63]

tWRRD_sg [Auto]

Configuration options: [Auto] [0] - [127]

tWRRD_dg [Auto]

Configuration options: [Auto] [0] - [63]

tRDRD_dr [Auto]

Configuration options: [Auto] [0] - [63]

tRDRD_dd [Auto]

Configuration options: [Auto] [0] - [63]

tRDWR_dr [Auto]

Configuration options: [Auto] [0] - [63]

tRDWR_dd [Auto]

Configuration options: [Auto] [0] - [63]

tWRWR_dr [Auto]

Configuration options: [Auto] [0] - [63]

tWRWR_dd [Auto]

Configuration options: [Auto] [0] - [63]

tWRRD_dr [Auto]

Configuration options: [Auto] [0] - [63]

tWRRD_dd[Auto]

Configuration options: [Auto] [0] - [63]

TWRPRE [Auto]

Configuration options: [Auto] [0] - [127]

TRDPRE [Auto]

Configuration options: [Auto] [0] - [15]

tREFIX9 [Auto]

Configuration options: [Auto] [0] - [127]

OREF_RI[Auto]

Configuration options: [Auto] [0] - [255]

Misc.**MRC Fast Boot [Auto]**

Allows you to enable, disable or automatically set the MRC fast boot.

Configuration options: [Auto] [Enabled] [Disabled]

DRAM CLK Period [Auto]

Configuration options: [Auto] [1] - [40]

Memory Scrambler [Enabled]

Set this item to enable or disable memory scrambler support.

Configuration options: [Enabled] [Disabled]

Channel A DIMM Control [Enable Both DIMMS]

Allows you to enable or disable the Channel A DIMM slots.

Configuration options: [Enable Both DIMMS] [Disable DIMM0] [Disable DIMM1]
[Disable Both DIMMS]

Channel B DIMM Control [Enable Both DIMMS]

Allows you to enable or disable the Channel B DIMM slots.

Configuration options: [Enable Both DIMMS] [Disable DIMM0] [Disable DIMM1]
[Disable Both DIMMS]

MCH Full Check [Auto]

Enable this item to enhance the stability of your system. Disable this item to enhance the DRAM overclocking capability.

Configuration options: [Auto] [Enabled] [Disabled]

DLLBwEn [Auto]

Configuration options: [Auto] [1] - [7]

DRAM SPD Write [Disabled]

For advanced DRAM programming only. Enable DRAM SPD write to enable memory SMBus programming.

Configuration options: [Disabled] [Enabled]

DIGI+ VRM

CPU Load-line Calibration [Auto]

Load-line is defined by Intel® specification and affects CPU power voltage. The CPU working voltage decreases proportionally to CPU loading. Higher load-line calibration could get higher voltage and good overclocking performance, but increases the CPU and VRM thermal conditions. Select from levels 1 to 8 to adjust the CPU power voltage from 0% to 100%.

Configuration options [Auto] [Level 1] - [Level 8]



The actual performance boost may vary depending on your CPU specification.



DO NOT remove the thermal module. The thermal conditions should be monitored.

CPU Current Capability [Auto]

This item provides a total power range for CPU overclocking. A higher value setting provides higher power consumption delivery and extends the overclocking frequency range simultaneously.

Configuration options: [Auto] [100%] [110%] [120%] [130%] [140%]



Configure higher values when overclocking or under a high CPU loading for extra power support.

CPU VRM Switching Frequency [Auto]

This item affects the VRM transient response speed and the component thermal production. Select [Manual] to configure a higher frequency for a quicker transient response speed.

Configuration options: [Auto] [Manual]



DO NOT remove the thermal module. The thermal conditions should be monitored.



The following item appears only when you set the CPU VRM Switching Frequency to [Manual].

Fixed CPU VRM Switching Frequency (KHz) [300]

This item allows you to set a higher frequency for a quicker transient response speed. Use the <+> or <-> to adjust the value. The values range from 300 KHz to 600 KHz with an interval of 50 KHz.



Do not remove the thermal module when the manual mode is selected. The thermal conditions should be monitored.



The following item appears only when the CPU VRM Switching Frequency is set to **[Auto]**.

VRM Spread Spectrum [Disabled]

This item allows to enhance the system stability.

Configuration options: [Disabled] [Enabled]

CPU Power Duty Control [T.Probe]

DIGI + VRM Duty Control adjusts the current of every VRM phase and the thermal conditions of every phase component.

[T. Probe] Select to set the VRM thermal balance mode.

[Extreme] Select to set the VRM current balance mode.



DO NOT remove the thermal module. The thermal conditions should be monitored.

CPU Power Phase Control [Auto]

This item allows you to set the power phase control of the CPU.

Configuration options: [Auto] [Standard] [Optimized] [Extreme]



DO NOT remove the thermal module when setting this item to **[Extreme]**. The thermal conditions should be monitored.

CPU Graphic Load-line Calibration [Auto]

Load-line is defined by IntelR specification and affects CPU power voltage. The CPU working voltage decreases proportionally to CPU loading. Higher load-line calibration could get higher voltage and good overclocking performance, but increases the CPU and VRM thermal conditions. Select from levels 1 to 7 to adjust the CPU power voltage from 0% to 100%.

[Auto] [Level 1] - [Level 7]

CPU Graphics Current Capability [Auto]

The GT current capability adjusts the total power range for GT overclocking. A higher value provides a wider total power range and extends the overclocking frequency range simultaneously.

Configuration options: [Auto] [100%] [110%] [120%] [130%]

CPU Graphics [Auto]

The switching frequency will affect the GT transient response speed and the component thermal production. Select the manual mode to configure a higher frequency to get a quicker transient response speed.

[Auto] [Manual]



The following item appears only when you set the CPU Graphics to **[Manual]**.

Fixed VCCGT Switching Frequency(KHz) [300]

This item allows you to set a higher frequency for a quicker transient response speed. Use the <+> or <-> to adjust the value. The values range from 300 KHz to 600 KHz with an interval of 50 KHz.

GT Power Phase Control [Auto]

This item allows you to set the power phase control of the CPU.

Configuration options: [Auto] [Standard] [Optimized] [Extreme]



DO NOT remove the thermal module when setting this item to **[Extreme]**. The thermal conditions should be monitored.

Boot Voltages

CPU Core/Cache Boot Voltage [Auto]

Configuration options: [Auto] [0.600] - [1.700]

DMI Boot Voltage [Auto]

Configuration options: [Auto] [0.300] - [1.900]

CPU System Agent Boot Voltage [Auto]

Configuration options: [Auto] [0.7000] - [1.8000]

CPU VCCIO Boot Voltage [Auto]

Configuration options: [Auto] [0.7000] - [1.8000]

CPU Standby Boot Voltage [Auto]

The voltage for CPU standby at initial Boot.

Configuration options: [Auto] [0.7000] - [1.8000] [0.700~2.200]

Internal CPU Power Management

The subitems in this menu allow you to set the CPU ratio and features.

Intel(R) SpeedStep(tm) [Enabled]

Allows the operating system to dynamically adjust the processor voltage and cores frequency to decrease the average power consumption and decrease average heat production. Configuration options: [Enabled] [Disabled]

Turbo Mode [Enabled]

Allows you to enable your processor cores to run faster than the base operating frequency when it is below power, current and specification limit. Configuration options: [Disabled] [Enabled]



The following items appear only when you set the Turbo Mode to **[Enabled]**.

Turbo Mode Parameters

Long Duration Package Power Limit [Auto]

Allows you to limit the Turbo Ratio's time duration that exceeds the TDP (Thermal Design Power) for maximum performance. Use the <+> and <-> keys to adjust the value.

Configuration options: [Auto] [1] - [4095]

Package Power Time Window [Auto]

Also known as Power Limit 1, and allows you to maintain the time window for Turbo Ratio over TDP (Thermal Design Power). Use the <+> and <-> keys to adjust the value.

Configuration options: [Auto] [1] - [127]

Short Duration Package Power Limit [Auto]

Also known as Power Limit 2, and allows you to provide rapid protection when the package power exceeds the Power Limit 1. Use the <+> and <-> keys to adjust the value.

Configuration options: [Auto] [1] - [4095]

IA AC Load Line [Auto]

This item allows you to set the AC loadline defined in 1/100 mOhms. Use the <+> and <-> keys to adjust the value.

Configuration options: [Auto] [0.01] - [62.49]

IA DC Load Line [Auto]

This item allows you to set the DC loadline defined in 1/100 mOhms. Use the <+> and <-> keys to adjust the value.

Configuration options: [Auto] [0.01] - [62.49]

Tweaker's Paradise

Initial BCLK Frequency [Auto]

This item allows you to start overclocking the system from the initial BCLK (base clock) frequency to the assigned BCLK frequency. Use the <+> or <-> to adjust the value. The values range from 40.0 MHz to 500.0 MHz.

BCLK Amplitude [Auto]

This item allows you to set the magnitude of the base clock driven for the processor. Configuration options: [Auto] [700mV] [800mV] [900mV] [1000mV]

BCLK Slew Rate [Auto]

This item allows you to set the speed at which each clock rises and falls. Configuration options: [Auto] [1.5V/ns] [2.5V/ns] [3.5V/ns] [4.5V/ns]

BCLK Spread Spectrum [Auto]

This item allows you to reduce the EMI. Disable to get more accurate base clocks. Configuration options: [Auto] [Disabled] [-0.22] [-0.34] [-0.46] [+0.12] [+0.22] [+0.28] [+0.38] [+0.17]

BCLK Frequency Slew Rate [Auto]

Configuration options: [Auto] [Disabled] [32us/MHz] [64us/MHz] [128us/MHz] [512us/MHz]

DRAM VTT Voltage [Auto]

Configuration options: [Auto] [0.500] - [1.300]

VPPDDR Voltage [Auto]

Configuration options: [Auto]

DMI Voltage [Auto]

Configuration options: [Auto] [0.30000] - [1.90000]

Core PLL Voltage [Auto]

Configuration options: [Auto] [0.70000] - [2.40000]

PLL Bandwidth [Auto]

Configuration options: [Auto] [Level 0] - [Level 10]

CPU Core/Cache Current Limit Max. [Auto]

This item allows you to configure a higher current limit to prevent a frequency or power throttling when overclocking. Use the <+> and <-> keys to adjust the value.

Configuration options: [Auto] [0.00] - [255.50]

CPU Graphics Current Limit Max. [Auto]

This item allows you to set a higher current limit to prevent a frequency or power throttling when overclocking. Use the <+> and <-> keys to adjust the value.

Configuration options: [Auto] [0.00] - [255.50]

Min. CPU Cache Ratio [Auto]

This item allows you to set the minimum possible CPU cache ratio. Use the <+> and <-> keys to adjust the value.

Configuration options: [Auto] [8] - [26]

Max. CPU Cache Ratio [Auto]

This item allows you to set the maximum possible CPU cache ratio. Use the <+> and <-> keys to adjust the value.

Configuration options: [Auto] [8] - [26]

Max. CPU Graphics Ratio [Auto]

This item allows you to set the CPU graphics ratio. The ratio may vary depending on the system loading. Use the <+> and <-> keys to adjust the value.

Configuration options: [Auto] [1] - [19]

Extreme Over-voltage [Disabled]

Enable this item to allow higher voltages for overclocking, but the CPU lifetime will not be guaranteed.

Configuration options: [Enabled] [Disabled]



This item can only be enabled when the onboard CPU_OV jumper is switched on.

CPU Core/Cache Voltage [Auto]

Configures the mode of Voltage fed to the cores of the processor.

Configuration options: [Auto] [Manual Mode] [Offset Mode] [Adaptive Mode]

DRAM Voltage [Auto]

Configuration options: [Auto] [1.0000] - [2.0000]

CPU VCCIO Voltage [Auto]

Configuration options: [Auto] [0.70000] - [1.80000]

CPU System Agent Voltage [Auto]

Configuration options: [Auto] [0.70000] - [1.80000]

CPU Graphics Voltage Mode [Auto]

[Auto] The system automatically determines the CPU Graphics Voltage.

[Manual Mode] This item allows user-defined values.

[Offset Mode] This item allows you to modify values by SVID.

PCH Core Voltage [Auto]

Configuration options: [Auto] [0.70000] - [1.80000]

CPU Standby Voltage [Auto]

Configuration options: [Auto]

DRAM REF Voltage Control

DRAM CTRL REF Voltage on CHA/CHB [Auto]

Configures the DRAM reference voltage on the control lines. The reference voltage will be the DRAM voltage times the configured value.

Configuration options: [Auto] [0.39500] - [0.63000]

DRAM DATA REF Voltage on CHA DIMM0 Rank0 BL0-7 [Auto]

Configures the DRAM Data REF Voltage.

Configuration options: [Auto] [0] - [63]

DRAM DATA REF Voltage on CHA DIMM0 Rank1 BL0-7 [Auto]

Configures the DRAM Data REF Voltage.

Configuration options: [Auto] [0] - [63]

DRAM DATA REF Voltage on CHA DIMM1 Rank0 BL0-7 [Auto]

Configures the DRAM Data REF Voltage.

Configuration options: [Auto] [0] - [63]

DRAM DATA REF Voltage on CHA DIMM1 Rank1 BL0-7 [Auto]

Configures the DRAM Data REF Voltage.

Configuration options: [Auto] [0] - [63]

DRAM DATA REF Voltage on CHB DIMM0 Rank0 BL0-7 [Auto]

Configures the DRAM Data REF Voltage.

Configuration options: [Auto] [0] - [63]

DRAM DATA REF Voltage on CHB DIMM0 Rank1 BL0-7 [Auto]

Configures the DRAM Data REF Voltage.

Configuration options: [Auto] [0] - [63]

DRAM DATA REF Voltage on CHB DIMM1 Rank0 BL0-7 [Auto]

Configures the DRAM Data REF Voltage.

Configuration options: [Auto] [0] - [63]

DRAM DATA REF Voltage on CHB DIMM1 Rank1 BL0-7 [Auto]

Configures the DRAM Data REF Voltage.

Configuration options: [Auto] [0] - [63]

2.6 Advanced menu

The Advanced menu items allow you to change the settings for the CPU and other system devices.



Be cautious when changing the settings of the Advanced menu items. Incorrect field values can cause the system to malfunction.

ASUS UEFI BIOS Utility - Advanced Mode

02/20/2016 Monday 02:07 English MyFavorite(F3) Qfan Control(F6) EZ Tuning Wizard(F11) Quick Note(F9) Hot Keys

My Favorites Main AI Tweaker **Advanced** Monitor Boot Tool Exit

- > CPU Configuration
- > Platform Misc Configuration
- > System Agent (SA) Configuration
- > PCH Configuration
- > PCH Storage Configuration
- > USB Configuration
- > Network Stack Configuration
- > Onboard Devices Configuration
- > APM Configuration
- > HDD SMART Information
- > Intel(R) Thunderbolt

Hardware Monitor

CPU

Frequency	Temperature
2200 MHz	32°C
BCLK	Core Voltage
100.0 MHz	2.064 V
Ratio	
22x	

Memory

Frequency	Voltage
2133 MHz	2.416 V
Capacity	
4096 MB	

Voltage

+12V	+5V
12.096 V	5.040 V
+3.3V	
3.360 V	

Version 2.17.1246. Copyright (C) 2015 American Megatrends, Inc. Last Modified EzMode(F7)

2.6.1 CPU Configuration

The items in this menu show the CPU-related information that the BIOS automatically detects.



The items in this menu may vary based on the CPU installed.

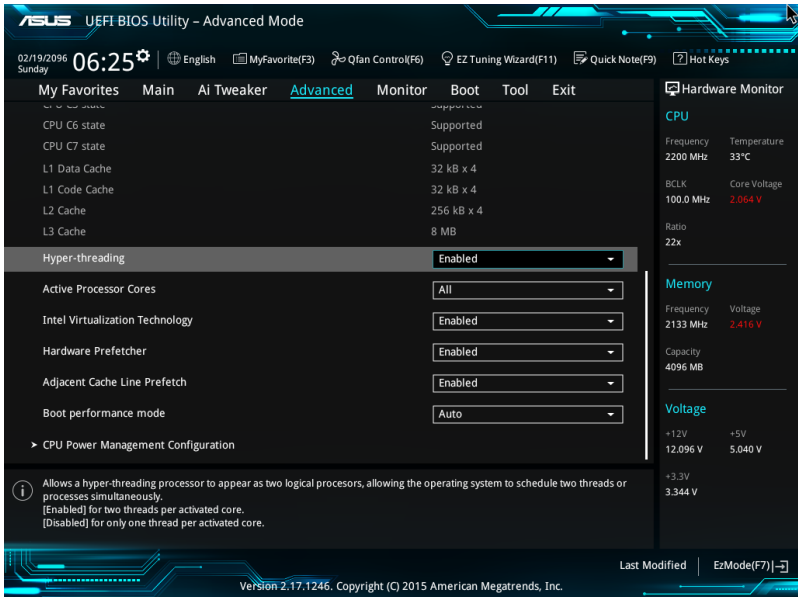

Hyper-threading [Enabled]

This item allows a hyper-threading processor to appear as two logical processors, allowing the operating system to schedule two threads or processors simultaneously.

Configuration options: [Disabled] [Enabled]

Active Processor Cores [All]

This item allows you to select the number of CPU cores to activate in each processor package.

Configuration options: [All] [1] [2] [3]

Intel Virtualization Technology [Enabled]

When set to [Enabled], a VMM can utilize the additional hardware capabilities provided by Vanderpool Technology.

Configuration options: [Disabled] [Enabled]

Hardware Prefetcher [Enabled]

This item allows the CPU to prefetch commands and data in the L2 cache, reduces the DRAM loading time and improves the system performance.

Configuration options: [Disabled] [Enabled]

Adjacent Cache Line Prefetcher [Enabled]

This item allows the mid level cache (L2) to prefetch adjacent cache lines, reducing the DRAM loading time and improves the system performance.

Configuration options: [Disabled] [Enabled]

Boot Performance Mode [Auto]

This item allows you to select the CPU performance state during system boot before the operating system takes control. The CPU runs at a selected performance ratio based on CPU configuration.

Configuration options: [Auto] [Max Non-Turbo Performance] [Max Battery] [Turbo Performance]

CPU Power Management Configuration

This item allows you to manage and configure the CPU's power.

Intel SpeedStep(tm) [Enabled]

This item allows your system to adjust the CPU's voltage and cores frequency, resulting in decreased power consumption and heat production.

[Disabled] The CPU runs at its default speed.

[Enabled] The system controls the CPU speed.

Turbo Mode [Enabled]

This item allows you to automatically set the CPU cores to run faster than the base operating frequency when it is below the operating power, current and temperature specification limit.

Configuration options: [Enabled] [Disabled]

CPU C-States [Enabled]

This item allows you to set the power saving of the CPU states.

Configuration options: [Disabled] [Enabled]



The following items appear only when you set the CPU C-States to **[Enabled]**.

Enhanced C-States [Disabled]

When enabled, CPU will switch to minimum speed when all cores enter C-State.

Configuration options: [Enabled] [Disabled]

CPU C3 Report [Enabled]

This item allows you to disable or enable the CPU C3 report to the operating system.

Configuration options: [Enabled] [Disabled]

CPU C6 Report [Enabled]

This item allows you to disable or enable the CPU C6 report to the operating system.

Configuration options: [Enabled] [Disabled]

Package C State Limit [Auto]

This item allows you to set the a C-state limit for the CPU package.

Configuration options: [C0/C1] [C2] [C3] [C6] [C7] [C7s] [Auto]

CFG Lock [Enabled]

This item allows you to disable or enable the CFG Lock.

Configuration options: [Enabled] [Disabled]

2.6.2 Platform Misc Configuration

The items in this menu allow you to configure the platform-related features.

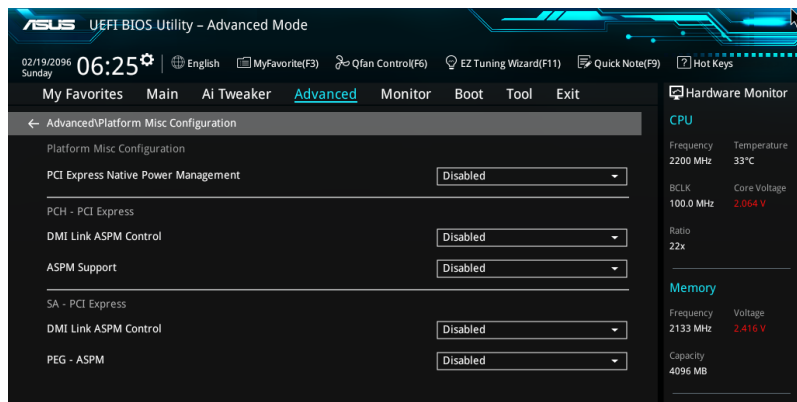

PCIe Native Power Management [Disabled]

This item allows you to enhance the power saving feature of PCI Express and perform ASPM operations in the operating system.

Configuration options: [Disabled] [Enabled]



The following item appears only when you set the PCI Express Native Power Management to [Enabled].

Native ASPM [Disabled]

[Enabled] Windows® Vista OS controls the ASPM (active state power management) support for devices.

[Disabled] BIOS controls the ASPM support for the device.

PCH - PCI Express

DMI Link ASPM Control [Disabled]

This item allows you to control the Active State Power Management on both NB (NorthBridge) side and SB (SouthBridge) side of the DMI Link.

Configuration options: [Disabled] [Enabled]

ASPM Support [Disabled]

This item allows you to select the ASPM state for energy-saving conditions.

Configuration options: [Disabled] [L0s] [L1] [L0sL1] [Auto]

SA - PCI Express

DMI Link ASPM Control [Disabled]

This item allows you to control the Active State Power Management on both CPU and PCH (platform controller hub) Both DMI link ASPM control items of the CPU and PCH sides must be enabled for the ASPM to take effect.

Configuration options: [Disabled] [L1]

PEG ASPM Support [Disabled]

This item allows you to select the ASPM state for energy-saving conditions, or use the ASUS optimized energy saving profile.

Configuration options: [Disabled] [Auto] [ASPM L0s] [ASPM L1] [ASPM L0sL1]

2.6.3 System Agent (SA) Configuration

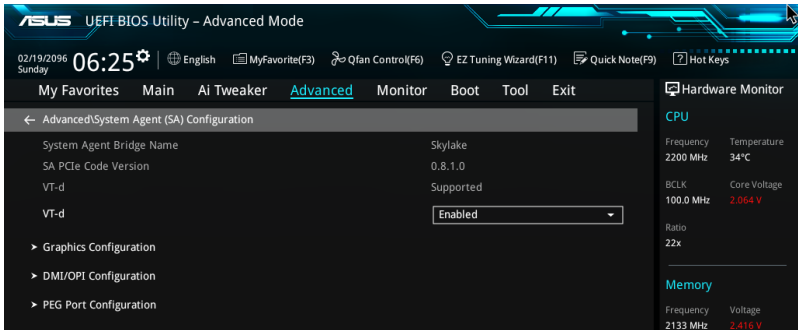

VT-d [Enabled]

Allows you to enable virtualization technology function on memory control hub.

Configuration options: [Enabled] [Disabled]

Graphics Configuration

This item allows you to select a primary display from CPU and PCIe graphical devices.

Primary Display [Auto]

This item allows you to select the primary display from CPU and PCIe devices.

Configuration options: [Auto] [IGFX] [PEG] [PCIE]

iGPU Multi-Monitor [Disabled]

This item allows you to enable the iGPU Multi-Monitor. The iGPU shared system memory size is fixed 64 MB.

Configuration options: [Disabled] [Enabled]

DMI/OPI Configuration

This item allows you to control various DMI (direct media interface) functions.

DMI Max Link Speed [Auto]

Set this item to [Enabled] to set DMI speed.

Configuration options: [Auto] [Gen1] [Gen2] [Gen3]

PEG Port Configuration

This item allows you to configure the PEG Port settings.

PCIEx16_1 Link Speed [Auto]

This item allows you to configure the PCIEx16_1 slot.

Configuration options: [Auto] [Gen1] [Gen2] [Gen3]

PCIEx16_2 Link Speed [Auto]

This item allows you to configure the PCIEx16_2 slot.

Configuration options: [Auto] [Gen1] [Gen2] [Gen3]

2.6.4 PCH Configuration

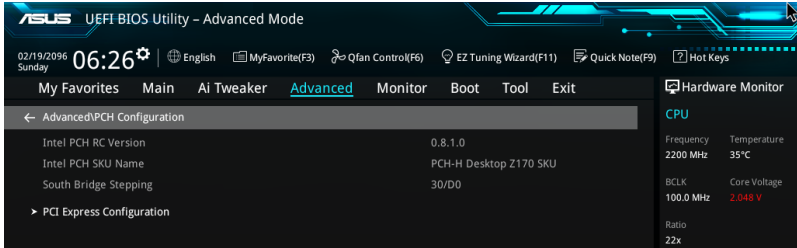

PCI Express Configuration

This item allows you to configure the PCI Express slots.

PCIe Speed [Auto]

This item allows your system to automatically select the PCI Express port speed.

Configuration options: [Auto] [Gen1] [Gen2] [Gen3]

2.6.5 PCH Storage Configuration

While entering Setup, the BIOS automatically detects the presence of SATA devices. The SATA Port items show **Not Present** if no SATA device is installed to the corresponding SATA port.

Scroll down to display the other BIOS items.

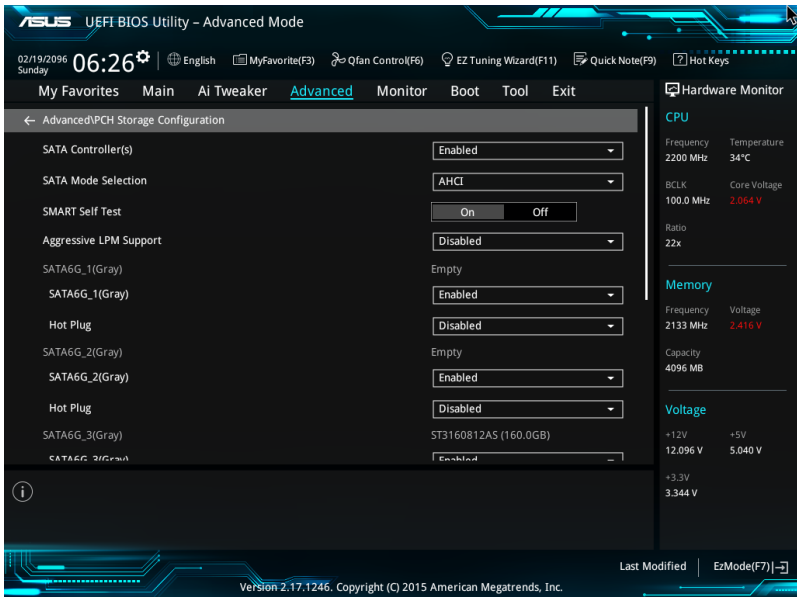

SATA Controller(s) [enabled]

This item allows you to enable or disable the SATA Device.

Configuration options: [Disabled] [Enabled]

SATA Mode Selection [AHCI]

This item allows you to set the SATA configuration.

[AHCI] Set to [AHCI] when you want the SATA hard disk drives to use the AHCI (Advanced Host Controller Interface). The AHCI allows the onboard storage driver to enable advanced Serial ATA features that increases storage performance on random workloads by allowing the drive to internally optimize the order of commands.

[RAID] Set to [RAID] when you want to create a RAID configuration from the SATA hard disk drives.



The following item appears only when you set the SATA Mode Selection to [RAID].

M.2 PCIe Storage RAID Support [Disabled]

This item allows you to enable or disable PCIe port to SATA for RAID Remapping.

Configuration options: [Disabled] [Enabled]

SATA Express PCIe Storage RAID Support [Disabled]

This item allows you to enable or disable PCIe port to SATA for RAID Remapping.

Configuration options: [Disabled] [Enabled]

PCIEX16_3 PCIe Storage RAID Support [Disabled]

This item allows you to enable or disable PCIe port to SATA for RAID Remapping.

Configuration options: [Disabled] [Enabled]

Aggressive LPM Support [Disabled]

This item is designed for LPM (link power management) support with a better energy saving conditions. When disabled, the hot plug function of SATA ports are disabled.

Configuration options: [Disabled] [Enabled]

SATA6G_1(Gray) - SATA6G_6(Gray)

SATA6G_1(Gray) - SATA6G_6(Gray) [Enabled]

This item allows you to enable or disable the selected SATA port.

Configuration options: [Disabled] [Enabled]

Hot Plug [Disabled]

These items appears only when the SATA Mode Selection is set to [AHCI] and allows you to enable or disable SATA Hot Plug Support.

Configuration options: [Disabled] [Enabled]

2.6.6 USB Configuration

The items in this menu allow you to change the USB-related features.

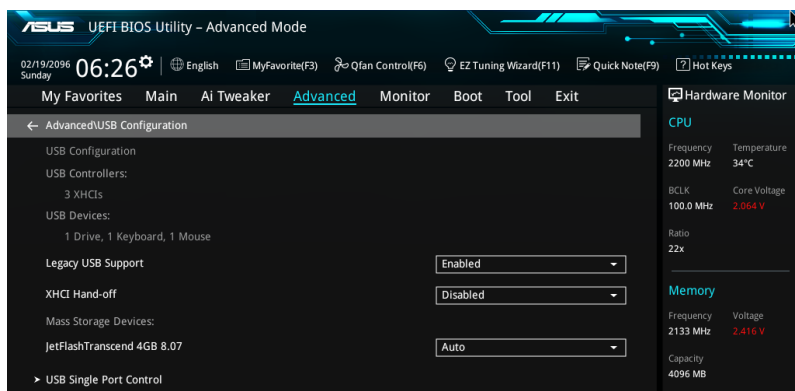

The **Mass Storage Devices** item shows the auto-detected values. If no USB device is detected, the item shows **None**.

Legacy USB Support [Enabled]

- [Enabled] Your system supports the USB devices in legacy operating systems.
- [Disabled] Your USB devices can be used for BIOS setup only and cannot be recognized in the boot devices list.
- [Auto] Your system automatically detects the presence of USB devices at startup. If any USB devices are detected, the legacy USB support is enabled.

XHCI Hand-off [Disabled]

- [Enabled] Enables the support for operating systems without an XHCI hand-off feature.
- [Disabled] Disables the XHCI Hand-off support.

USB Single Port Control

This item allows you to enable or disable the individual USB ports.



Refer to section **1.2.3 Motherboard layout** for the location of the USB ports.

2.6.7 Network Stack Configuration

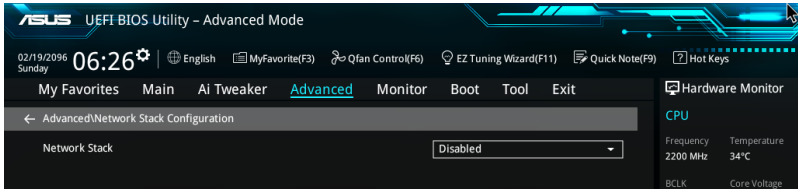

Network stack [Disable]

This item allows you to disable or enable the UEFI network stack.

Configuration options: [Disable] [Enable]



The following item appears only when you set the Network Stack to [Enabled].

Ipv4/Ipv6 PXE Support [Enabled]

This item allows you to enable or disable the Ipv4/Ipv6 PXE wake event.

Configuration options: [Disabled] [Enabled]

2.6.8 Onboard Devices Configuration

Scroll down to view the other BIOS items.

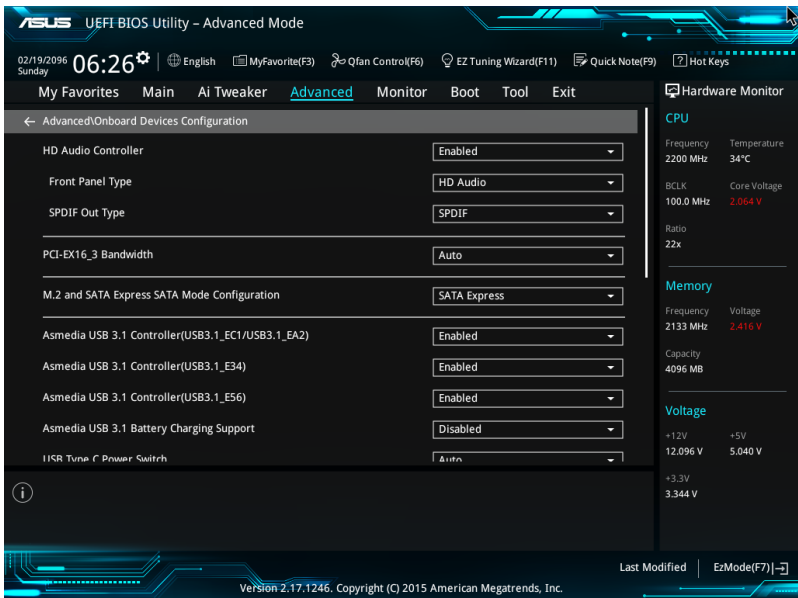

HD Audio Controller [Enabled]

This item allows you to use the Azalia High Definition Audio Controller

Configuration options: [Disabled] [Enabled]



The following items appear only when you set the HD Audio Controller to **[Enabled]**.

Front Panel Type [HD Audio]

This item allows you to set the front panel audio connector (AAFP) mode to legacy AC'97 or high-definition audio depending on the audio standard that the front panel audio module supports.

[HD Audio] Sets the front panel audio connector (AAFP) mode to high definition audio.

[AC97] Sets the front panel audio connector (AAFP) mode to legacy AC'97

SPDIF Out Type [SPDIF]

[SPDIF] Sets to an SPDIF audio output.

[HDMI] Sets to an HDMI audio output.

Audio LED Lighting [Breathing Mode]

[Disabled] Turn off the Audio LED.

[Still Mode] Turn on the Audio LED.

[Breathing Mode] Turn on Audio LED breathing mode.



The following items appear only when you set the Audio LED Lighting to **[Still Mode]** or **[Breathing Mode]**.

S3/S4/S5 Audio LED [Disabled]

This item allows you to enable or disable the audio LED in S3/S4/S5 mode.

Configuration Options: [Disabled] [Enabled]

M.2 and SATA Express Mode Configuration [SATA EXPRESS]

[M.2] SATA mode will be switched to M.2. SATA Express can only support PCIe devices.

[SATA Express] SATA mode will be switched to SATA Express. M.2 can only support PCIe devices.

ASMedia USB 3.1 Controller [Enabled]

This item allows you to disable or enable the ASMedia® USB 3.1 controller of your system.

Configuration options: [Disabled] [Enabled]

ASMedia USB 3.1 Battery Charging Support [Disabled]

This item allows you to disable or enable the ASMedia USB 3.1 battery charging support of your system.

Configuration options: [Disabled] [Enabled]

USB Type C Power Switch [Auto]

[Auto] The system will automatically detect your USB Type C devices and provide suitable power if needed.

[Enabled] The USB Type C port will always provide power to your devices.

Intel LAN Controller [Enabled]

This item allows you to enable or disable the Intel LAN1/2 controllers.

Configuration options: [Disabled] [Enabled]



The following item appears only when you set the Intel LAN Controller to **[Enabled]**.

Intel PXE OPROM [Disabled]

This item allows you to enable or disable the PXE OptionRom of the Intel® LAN controller.

Configuration options: [Enabled] [Disabled]

Serial Port Configuration

The items in this menu allows you to set the parameters of the serial port.



This items in this menu works only if a serial port connector is installed on the motherboard.

Serial Port [On]

This item allows you to enable/disable the serial port.

Configuration options: [On] [Off]

Change Settings [IO=3F8h; IRQ=4]

This item allows you to select an optimal setting for Super IO device.

Configuration options: [IO=3F8h; IRQ=4] [IO=2F8h; IRQ=3] [IO=3E8h; IRQ=4] [IO=2E8h; IRQ=3]

2.6.9 APM Configuration

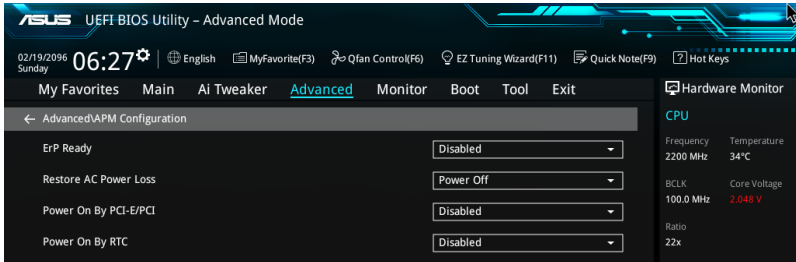

ErP Ready [Disabled]

This item allows you to switch off some power at S4+S5 or S5 to get the system ready for ErP requirement. When set to **[Enabled]**, all other PME options are switched off.

Configuration options: [Disabled] [Enabled (S4+S5)] [Enabled (S5)]

Restore AC Power Loss [Power Off]

This item allows your system to go to ON state, OFF state, or both states after an AC power loss. When setting your system to [Last State], it goes to the previous state before the AC power loss.

Configuration options: [Power Off] [Power On] [Last State]

Power On By PCI-E/PCI [Disabled]

This item allows you to enable or disable the Wake-on-LAN function of the onboard LAN controller or other installed PCI-E LAN cards.

Configuration options: [Disabled] [Enabled]

Power On By Ring [Disabled]

This item allows you to enable/disable the Power On by Ring feature of your motherboard.

Configuration options: [Disabled] [Enabled]

Power On By RTC [Disabled]

This item allows you to enable or disable the RTC (Real-Time Clock) to generate a wake event and configure the RTC alarm date. When enabled, you can set the days, hours, minutes, or seconds to schedule an RTC alarm date.

Configuration options: [Disabled] [Enabled]

2.6.10 HDD/SSD SMART Information

This menu displays the SMART information of the connected devices.

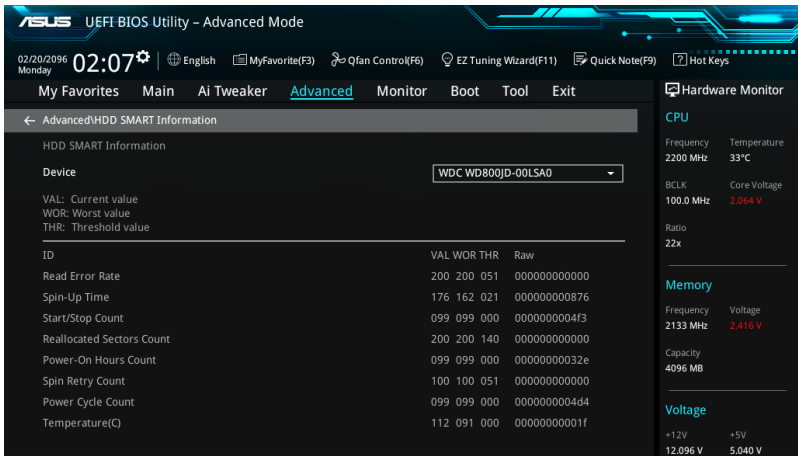

2.6.11 Intel(R) Thunderbolt

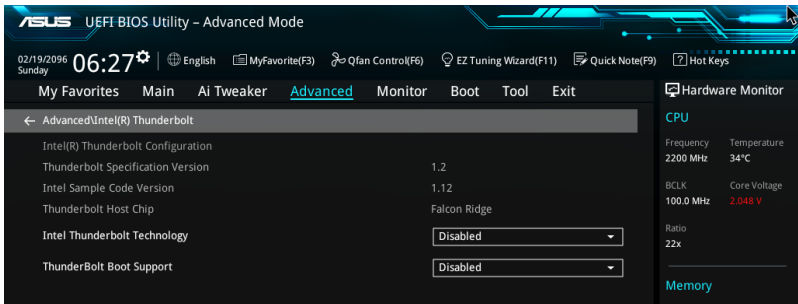

Intel Thunderbolt Technology [Disabled]

This item allows you to disable or enable the Intel Thunderbolt Technology.
Configuration options: [Fully Disabled] [Disabled] [Enabled]

Thunderbolt Boot Support [Disabled]

This item allows you to disable or enable the Thunderbolt Boot Support.
Configuration options: [Disabled] [Enabled]

2.7 Monitor menu

The Monitor menu displays the system temperature/power status, and allows you to change the fan settings.

Scroll down to display the other BIOS items.

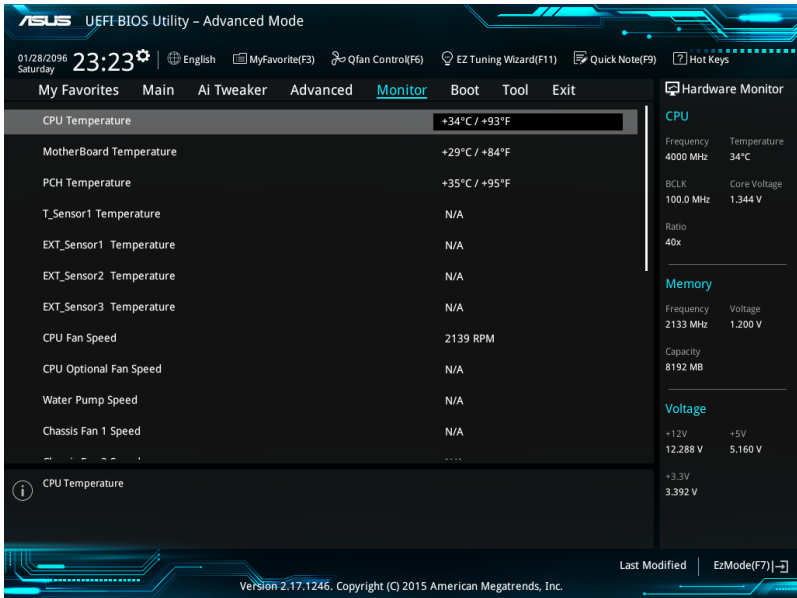

CPU Temperature / MB Temperature / VRM Temperature / PCH Core Temperature / EXT_SENSOR1-3 Temperature [xxx°C/xxx°F]

The onboard hardware monitor automatically detects and displays the CPU, motherboard, VRM, PCH Core, and SENSOR1 temperatures. Select **[Ignore]** if you do not wish to display the detected temperatures.

CPU Fan Speed, CPU Optional Fan, Water Pump Speed, Chassis Fan 1-2 Speed, EXT Fan 1-3 [xxxx RPM] or [Ignore] / [N/A]

The onboard hardware monitor automatically detects and displays the CPU, chassis, and power fan speed in rotations per minute (RPM). If the fan is not connected to the motherboard, the field shows N/A. Select **[Ignore]** if you do not wish to display the detected speed.

CPU Core Voltage, 3.3V Voltage, 5V Voltage, 12V Voltage

The onboard hardware monitor automatically detects the voltage output through the onboard voltage regulators. Select **[Ignore]** if you do not want to detect this item.

Q-fan Configuration

Q-fan Tuning

Click this item to automatically detect the lowest speed and configure the minimum duty cycle for each fan.

CPU Q-Fan Control [Auto]

- [Auto] Detect the type of CPU fan installed and automatically switches the mode control.
- [PWM Mode] Enable the CPU Q-Fan control feature in PWM mode for 4-pin CPU fan.
- [DC Mode] Enable the CPU Q-Fan control feature in DC mode for 3-pin CPU fan.
- [Disabled] Disable the Q-Fan control.

CPU Fan Step Up [0 sec]

This item allows you to set the value of the CPU fan step up.

Configuration options: [0 sec] [2.1 sec] [2.8 sec] [3.6 sec] [4.5 sec] [5.0 sec] [6.3 sec] [8.5 sec] [12 sec] [25 sec]

CPU Fan Step Down [0 sec]

This item allows you to set the value of the CPU fan step down.

Configuration options: [0 sec] [2.1 sec] [2.8 sec] [3.6 sec] [4.5 sec] [5.0 sec] [6.3 sec] [8.5 sec] [12 sec] [25 sec]

CPU Fan Speed Lower Limit [200 RPM]

This item allows you to set the low limit warning for CPU Fan speed.

Configuration options: [Ignore] [200 RPM] [300 RPM] [400 RPM] [500 RPM] [600 RPM]

CPU Fan Profile [Standard]

This item allows you to set the appropriate performance level of the CPU fan.

- [Standard] Set to make the CPU fan adjust automatically depending on the CPU temperature.
- [Silent] Set to minimize the fan speed for quiet CPU fan operation.
- [Turbo] Set to achieve maximum CPU fan speed.
- [Manual] Set to assign the detailed fan speed control parameters.



The following items appear only when you set the CPU Fan Profile to **[Manual]**.

CPU Upper Temperature [70]

Use the <+> or <-> keys to adjust the upper limit of the CPU temperature. The values range from 25 to 75.

CPU Fan Max. Duty Cycle (%) [100]

Use the <+> or <-> keys to adjust the maximum CPU fan duty cycle. The values range from 20% to 100%. When the CPU temperature reaches the upper limit, the CPU fan will operate at the maximum duty cycle.

CPU Middle Temperature [25]

Use the <+> or <-> keys to adjust the middle limit of the CPU temperature. The values range from 20 to 75.

CPU Fan Middle. Duty Cycle (%) [20]

Use the <+> or <-> keys to adjust the maximum CPU fan duty cycle. The values range from 20% to 100%. When the CPU temperature reaches the upper limit, the CPU fan will operate at the maximum duty cycle.

CPU Lower Temperature [20]

Use the <+> or <-> keys to adjust the lower limit of the CPU temperature. The values range from 20 to 75. The CPU fan will operate at the minimum duty cycle when the temperature is lower than the limit.

CPU Fan Min. Duty Cycle(%) [20]

Use the <+> or <-> keys to adjust the minimum CPU fan duty cycle. The values range from 0% to 100%. When the CPU temperature is under the limit, the CPU fan will operate at the minimum duty cycle.

Chassis Fan 1-2 Q-Fan Control [DC Mode]

[Disabled] Disable the Chassis Q-Fan control feature.

[DC mode] Enable the Chassis Q-Fan control in DC mode for 3-pin chassis fan.

[PWM mode] Enable the Chassis Q-Fan control in PWM mode for 4-pin chassis fan.

Chassis Fan 1-2 Q-Fan Source [CPU]

The assignment fan will be controlled according to the selected temperature source.

Configuration options: [CPU] [MotherBoard] [VRM] [PCH] [EXT_Sensor1] [EXT_Sensor2] [EXT_Sensor3]



For EXT_Sensor1-3, connect a Thermistor cable to the EXT_TS1-3 header then place the other end to the component to get the temperature.

Chassis Fan 1-2 Step Up [0 sec]

This item allows you to set the value of the CPU fan step up.

Configuration options: [0 sec] [12 sec] [25 sec] [51 sec] [76 sec] [102 sec] [127 sec] [153 sec] [178 sec] [204 sec]

Chassis Fan 1-2 Step Down [0 sec]

This item allows you to set the value of the CPU fan step down.

Configuration options: [0 sec] [12 sec] [25 sec] [51 sec] [76 sec] [102 sec] [127 sec] [153 sec] [178 sec] [204 sec]

Chassis Fan 1-2 Fan Speed Low Limit [200 RPM]

This item allows you to disable or set the chassis fan warning speed.

Configuration options: [Ignore] [200 RPM] [300 RPM] [400 RPM] [500 RPM] [600 RPM]

Chassis Fan 1-2 Profile [Standard]

This item allows you to set the appropriate performance level of the chassis fan.

[Standard] Sets to [Standard] to make the chassis fan automatically adjust depending on the chassis temperature.

[Silent] Sets to [Silent] to minimize the fan speed for quiet chassis fan operation.

[Turbo] Sets to [Turbo] to achieve maximum chassis fan speed.

[Manual] Sets to [Manual] to assign detailed fan speed control parameters.



The following four items appear only when you set Chassis Fan 1-2 Profile to **[Manual]**.

Chassis Fan 1-2 Upper Temperature [70]

Use the <+> or <-> keys to adjust the upper limit of the Chassis Fan 1-2 temperature. The values range from 20 to 75.

Chassis Fan 1-2 Max. Duty Cycle (%) [100]

Use the <+> or <-> keys to adjust the maximum Chassis Fan 1-2 duty cycle. The values range from 20% to 100%. When the CPU temperature reaches the upper limit, the Chassis Fan 1-2 will operate at the maximum duty cycle.

Chassis Fan 1-2 Middle Temperature [45]

Use the <+> or <-> keys to adjust the middle limit of the Chassis Fan 1-2 temperature. The values range from 20 to 75.

Chassis Fan 1-2 Middle. Duty Cycle (%) [60]

Use the <+> or <-> keys to adjust the maximum Chassis Fan 1-2 duty cycle. The values range from 20% to 100%. When the CPU temperature reaches the upper limit, the Chassis Fan 1-2 will operate at the maximum duty cycle.

Chassis Fan 1-2 Lower Temperature [40]

Use the <+> or <-> keys to adjust the lower limit of the Chassis Fan 1-2 temperature. The values range from 20 to 75. The Chassis Fan 1-2 will operate at the minimum duty cycle when the temperature is lower than the limit.

Chassis Fan 1-2 Min. Duty Cycle(%) [60]

Use the <+> or <-> keys to adjust the minimum Chassis Fan 1-2 fan duty cycle. The values range from 0% to 100%. When the CPU temperature is under the limit, the Chassis Fan 1-2 fan will operate at the minimum duty cycle.

ASUS FAN EXTENSION CARD is required to configure these items

Extension Fan 1-3 Q-Fan Control [DC Mode]

- [Disabled] Disable the Extension Fan Q-Fan control feature.
- [DC mode] Enable the Extension Fan Q-Fan control in DC mode for 3-pin chassis fan.
- [PWM mode] Enable the Extension Fan Q-Fan control in PWM mode for 4-pin chassis fan.

Extension Fan 1-3 Q-Fan Source [CPU]

The assignment fan will be controlled according to the selected temperature source. Configuration options: [CPU] [MotherBoard] [VRM] [PCH] [EXT_Sensor1] [EXT_Sensor2] [EXT_Sensor3]



For EXT_Sensor1-3, connect a Thermistor cable to the EXT_TS1-3 header then place the other end to the component to get the temperature.

Extension Fan 1-3 Fan Speed Low Limit [200 RPM]

This item allows you to disable or set the chassis fan warning speed. Configuration options: [Ignore] [200 RPM] [300 RPM] [400 RPM] [500 RPM] [600 RPM]

Extension Fan 1-3 Profile [Standard]

This item allows you to set the appropriate performance level of the CPU fan.

- [Standard] Set to make the CPU fan adjust automatically depending on the CPU temperature.
- [Silent] Set to minimize the fan speed for quiet CPU fan operation.
- [Turbo] Set to achieve maximum CPU fan speed.
- [Manual] Set to assign the detailed fan speed control parameters.



The following items appear only when you set the Extension Fan Profile to **[Manual]**.

Extension Fan 1-3 Upper Temperature [70]

Use the <+> or <-> keys to adjust the upper limit of the Extension Fan 1-3 temperature. The values range from 20 to 75.

Extension Fan 1-3 Max. Duty Cycle (%) [100]

Use the <+> or <-> keys to adjust the maximum Extension Fan 1-3 duty cycle. The values range from 20% to 100%. When the CPU temperature reaches the upper limit, the Extension Fan 1-3 will operate at the maximum duty cycle.

Extension Fan 1-3 Middle Temperature [45]

Use the <+> or <-> keys to adjust the middle limit of the Extension Fan 1-3 temperature. The values range from 20 to 75.

Extension Fan 1-3 Middle. Duty Cycle (%) [60]

Use the <+> or <-> keys to adjust the maximum Extension Fan 1-3 duty cycle. The values range from 20% to 100%. When the CPU temperature reaches the upper limit, the Extension Fan 1-3 will operate at the maximum duty cycle.

Extension Fan 1-3 Lower Temperature [40]

Use the <+> or <-> keys to adjust the lower limit of the Extension Fan 1-3 temperature. The values range from 20 to 75. The Extension Fan 1-3 will operate at the minimum duty cycle when the temperature is lower than the limit.

Extension Fan 1-3 Min. Duty Cycle(%) [60]

Use the <+> or <-> keys to adjust the minimum Extension Fan 1-3 duty cycle. The values range from 0% to 100%. When the CPU temperature is under the limit, the Extension Fan 1-3 will operate at the minimum duty cycle.

Water Pump Control [Disabled]

- [Disabled] Disable the Water Pump control feature.
- [DC mode] Enable the Water Pump control in DC mode for 3-pin chassis fan.
- [PWM mode] Enable the Water Pump control in PWM mode for 4-pin chassis fan.



The following items appear only when you set the Water Pump Control to **[DC mode]** or **[PWM mode]**.

Water Pump Upper Temperature [25]

Use the <+> or <-> keys to adjust the upper limit of the Water Pump temperature. The values range from 20 to 75.

Water Pump Max. Duty Cycle (%) [100]

Use the <+> or <-> keys to adjust the maximum Extension Fan 1-3 duty cycle. The values range from 20% to 100%. When the CPU temperature reaches the upper limit, the Water Pump will operate at the maximum duty cycle.

Water Pump Middle Temperature [45]

Use the <+> or <-> keys to adjust the middle limit of the Water Pump temperature. The values range from 20 to 75.

Water Pump Middle. Duty Cycle (%) [20]

Use the <+> or <-> keys to adjust the maximum Water Pump duty cycle. The values range from 20% to 100%. When the CPU temperature reaches the upper limit, the Water Pump will operate at the maximum duty cycle.

Water Pump Lower Temperature [20]

Use the <+> or <-> keys to adjust the lower limit of the Water Pump temperature. The values range from 20 to 75. The Water Pump will operate at the minimum duty cycle when the temperature is lower than the limit.

Water Pump Min. Duty Cycle(%) [20]

Use the <+> or <-> keys to adjust the minimum Water Pump duty cycle. The values range from 0% to 100%. When the CPU temperature is under the limit, the Water Pump will operate at the minimum duty cycle.

Anti Surge Support [On]

Enable this item for Over Voltage Protection (OVP) and Under Voltage Protection (UVP) functions.

Configuration options: [On] [Off]

2.8 Boot menu

The Boot menu items allow you to change the system boot options.

The screenshot shows the ASUS UEFI BIOS Utility in Advanced Mode, specifically the Boot menu. The top navigation bar includes 'My Favorites', 'Main', 'AI Tweaker', 'Advanced', 'Monitor', 'Boot', 'Tool', and 'Exit'. The 'Boot' menu is expanded, showing a list of boot configuration options with their current settings:

- Fast Boot: Enabled
- SATA Support: HDD Only
- USB Support: Partial Initial
- PS2 Devices Support: Enabled
- NetWork Stack Driver Support: Disabled
- Next Boot after AC Power Loss: Normal Boot
- DirectKey (DRCT): Enabled
- Boot Logo Display: Auto
- POST Delay Time: 3 sec
- Boot up NumLock State: Enabled

At the bottom of the boot menu, there is an information icon and a note: "Enables or disables boot with initialization of a minimal set of devices required to launch active boot option. Has no effect for BIOS boot options."

On the right side, the 'Hardware Monitor' panel is visible, showing the following data:

- CPU**
 - Frequency: 4000 MHz
 - Temperature: 34°C
 - BCLK: 100.0 MHz
 - Core Voltage: 1.344 V
 - Ratio: 40x
- Memory**
 - Frequency: 2133 MHz
 - Voltage: 1.200 V
 - Capacity: 8192 MB
- Voltage**
 - +12V: 12.288 V
 - +5V: 5.160 V
 - +3.3V: 3.392 V

Fast Boot [Enabled]

- [Disabled] Allows your system to go back to its normal boot speed.
- [Enabled] Allows your system to accelerate the boot speed.



The following items appear only when you set the Fast Boot to **[Enabled]**.

SATA Support [HDD Only]

- [All Sata Devices] All devices connected to SATA ports are available during POST. This process extends the POST time.
- [HDD Only] Only hard drives connected to SATA ports are detected during POST.
- [Last Boot HDD Only] Only boot drives connected to a SATA ports are detected during POST.

USB Support [Partial Initial]

- [Disabled] All USB devices will not be available until OS boot up for a fastest POST time.
- [Full Initial] All USB devices will be available during POST. This process will extend the POST time.
- [Partial Initial] For a faster POST time, only USB ports with keyboard and mouse connections will be detected.

PS2 Devices Support [Enabled]

Allows you to enable or disable control of the PS2 devices' availability during POST.
Configuration options: [Enabled] [Disabled]

Network Stack Driver Support [Disabled]

- [Disabled] Select to skip the network stack driver from loading during POST.
- [Enabled] Select to load the network stack driver during POST.

Next Boot after AC Power Loss [Normal Boot]

- [Normal Boot] Returns to normal boot on the next boot after an AC power loss.
- [Fast Boot] Accelerates the boot speed on the next boot after an AC power loss.

DirectKey (DRCT) [Enabled]

- [Disabled] Disables the DirectKey button. The system will only power on or off when you press the DirectKey button.
- [Enabled] Allows the system to power on and go to the BIOS Setup directly when you press the Reset button. Connect the 2-pin connector of the chassis reset button cable to the onboard DRCT header.

Boot Logo Display [Auto]

- [Auto] Sets the boot logo to display during POST.
[Full Screen] Sets the boot logo display in full screen during POST.
[Disabled] Disables the boot logo display during POST.

The following item appears only when you set the Boot Logo Display to **[Auto]** and **[Full Screen]**.

Post Delay Time [3 sec]

This item allows you to select a desired additional POST waiting time to easily enter the BIOS Setup. You can only execute the POST delay time during normal boot. The values range from 0 to 10 seconds.



This feature only works when set under normal boot.



The following items appear only when you set the Boot Logo Display to **[Disabled]**.

Post Report [5 sec]

This item allows you to select a desired POST report waiting time.

Configuration options: [1 sec] - [10 sec] [Until Press ESC]

Bootup NumLock State [Enabled]

This item allows you to enable or disable power-on state of the NumLock.

Configuration options: [Disabled] [Enabled]

Above 4G Decoding [Disabled]

This item enables or disables 64-bit capable devices to be decoded in above 4G address space if your system supports 64-bit PCI Decoding.

Configuration options: [Enabled] [Disabled]

Wait For 'F1' If Error [Enabled]

This item allows your system to wait for the <F1> key to be pressed when error occurs.

Configuration options: [Disabled] [Enabled]

Option ROM Messages [Force BIOS]

[Force BIOS] The Option ROM Messages will be shown during the POST.

[Disabled] Only the ASUS logo will be shown during the POST.

Interrupt 19 Capture [Disabled]

[Enabled] Execute the trap right away.

[Disabled] Execute the trap during legacy boot.

Setup Mode [EZ Mode]

[Advanced Mode] This item allows you to go to Advanced Mode of the BIOS after POST.

[EZ Mode] This item allows you to go to EZ Mode of the BIOS after POST.

CSM (Compatibility Support Module)

This item allows you to configure the CSM (Compatibility Support Module) items to fully support the various VGA, bootable devices and add-on devices for better compatibility.

Launch CSM [Enabled]

- [Auto] The system automatically detects the bootable devices and the add-on devices.
- [Enabled] For better compatibility, enable the CSM to fully support the non-UEFI driver add-on devices or the Windows® UEFI mode.
- [Disabled] Disable the CSM to fully support the non-UEFI driver add-on devices or the Windows® UEFI mode.



The following items appear only when you set the Launch CSM to **[Enabled]**.

Boot Devices Control [UEFI and Legacy OPRM]

This item allows you to select the type of devices that you want to boot.

Configuration options: [UEFI and Legacy OPRM] [Legacy OPRM only] [UEFI only]

Boot from Network Devices [Legacy only]

This item allows you to select the type of network devices that you want to launch.

Configuration options: [Legacy only] [UEFI driver first] [Ignore]

Boot from Storage Devices [Legacy only]

This item allows you to select the type of storage devices that you want to launch.

Configuration options: [Legacy only] [UEFI driver first] [Ignore]

Boot from PCI-E/PCI Expansion Devices [Legacy only]

This item allows you to select the type of PCI-E/PCI expansion devices that you want to launch.

Configuration options: [Legacy only] [UEFI driver first]

Secure Boot

This item allows you to configure the Windows® Secure Boot settings and manage its keys to protect the system from unauthorized access and malwares during POST.

OS Type [Windows UEFI mode]

- [Windows UEFI Mode] This item allows you to select your installed operating system. Execute the Microsoft® Secure Boot check. Only select this option when booting on Windows® UEFI mode or other Microsoft® Secure Boot compliant OS.
- [Other OS] Get the optimized function when booting on Windows® non-UEFI mode. Microsoft® Secure Boot only supports Windows® UEFI mode.

Key Management

Install Default Secure Boot keys

This item allows you to clear all default Secure Boot keys.

Save Secure Boot Keys

This item allows you to save the PK (Platform Keys) to a USB storage device.

PK Management

Set New Key

This item allows you to load the downloaded PK from a USB storage device.



The PK file must be formatted as a UEFI variable structure with time-based authenticated variable.

Delete Key

This item allows you to delete the PK from your system. Once the PK is deleted, all the system's Secure Boot keys will not be active.

Configuration options: [Yes] [No]

KEK Management



Key-exchange Key (KEK) refers to Microsoft® Secure Boot Key-Enrollment Key (KEK).

Delete Key

Allows you to delete the KEK from your system.

Configuration options: [Yes] [No]

Set New Key

Allows you to load the downloaded KEK from a USB storage device.

Append Key

Allows you to load the additional KEK from a storage device for an additional db and dbx loaded management.



The KEK file must be formatted as a UEFI variable structure with time-based authenticated variable.

DB Management

Delete Key

Allows you to delete the db file from your system.

Configuration options: [Yes] [No]

Set New Key

Allows you to load the downloaded db from a USB storage device.

Append Key

Allows you to load the additional db from a storage device so that more images can be loaded securely.



The db file must be formatted as a UEFI variable structure with time-based authenticated variable. DBX Management

DBX Management

Delete Key

Allows you to delete the dbx file from your system.

Set New Key

Allows you to load the downloaded dbx from a USB storage device.

Configuration options: [Yes] [No]

Append Key

Allows you to load the additional dbx from a storage device so that more db's images cannot be loaded.



The dbx file must be formatted as a UEFI variable structure with time-based authenticated variable.

Boot Option Priorities

These items specify the boot device priority sequence from the available devices. The number of device items that appears on the screen depends on the number of devices installed in the system.



- To access Windows® OS in Safe Mode, press <F8> after POST (Windows® 8 not supported).
 - To select the boot device during system startup, press <F8> when the ASUS Logo appears.
-

Boot Override

These items displays the available devices. The number of device items that appears on the screen depends on the number of devices installed in the system. Click an item to start booting from the selected device.

2.9 Tool menu

The Tool menu items allow you to configure options for special functions. Select an item then press <Enter> to display the submenu.

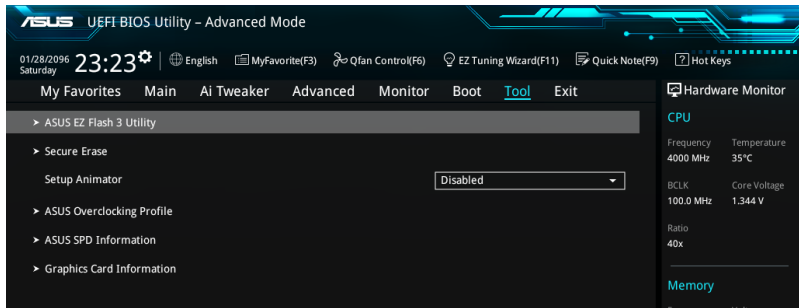

Setup Animator

This item allows you to enable or disable the Setup animator.

Configuration options: [Disabled] [Enabled]

2.9.1 ASUS EZ Flash 3 Utility

This item allows you to run ASUS EZ Flash 3. When you press <Enter>, a confirmation message appears. Use the left/right arrow key to select between [Yes] or [No], then press <Enter> to confirm your choice.



For more details, refer to section 2.11.2 **ASUS EZ Flash 3**.

2.9.2 Secure Erase

SSD speeds may lower over time as with any storage medium due to data processing. Secure Erase completely and safely cleans your SSD, restoring it to factory performance levels.



Secure Erase is only available in AHCI mode. Ensure to set the SATA mode to AHCI. Click **Advanced > SATA Configuration > AHCI**.

To launch Secure Erase, click **Tool > Secure Erase** on the Advanced mode menu.



Check the ASUS support site for a full list of SSDs tested with Secure Erase. The drive may become unstable if you run Secure Erase on an incompatible SSD.



- The time to erase the contents of your SSD may take a while depending on its size. Do not turn off the system during the process.
- Secure Erase is only supported on Intel SATA port. For more information about Intel SATA ports, refer to section 1.2.3 of this manual.

Displays the available SSDs

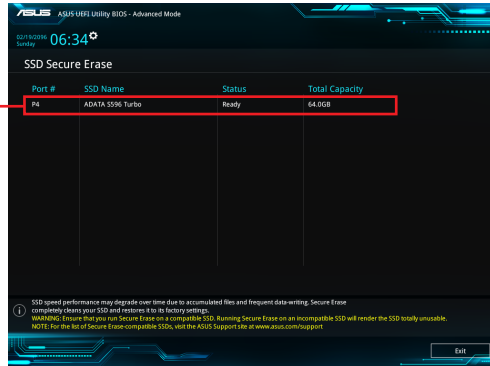

Status definition:

- **Frozen.** The frozen state is the result of a BIOS protective measure. The BIOS guards drives that do not have password protection by freezing them prior to booting. If the drive is frozen, a power off or hard reset of your PC must be performed to proceed with the Secure Erase.
 - **Locked.** SSDs might be locked if the Secure Erase process is either incomplete or was stopped. This may be due to a third party software that uses a different password defined by ASUS. You have to unlock the SSD in the software before proceeding with Secure Erase.
-

2.9.3 ASUS O.C. Profile

This item allows you to store or load multiple BIOS settings.

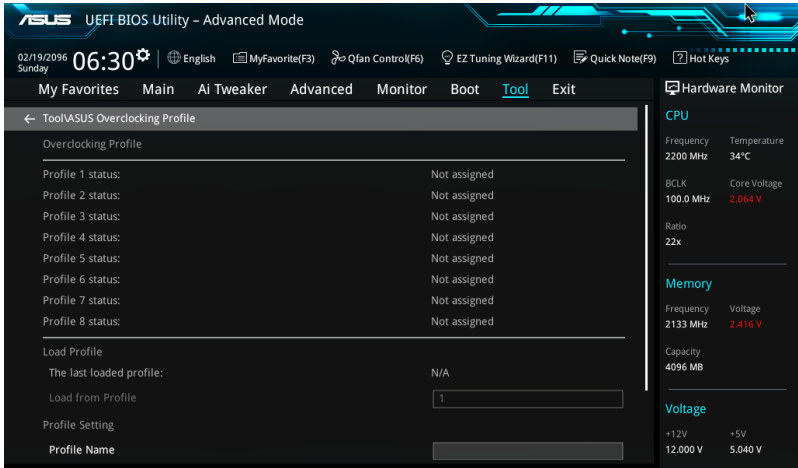

Load from Profile

This item allows you to load the previous BIOS settings saved in the BIOS Flash. Key in the profile number that saved your BIOS settings, press <Enter>, and then select **Yes**.



- DO NOT shut down or reset the system while updating the BIOS to prevent the system boot failure!
- We recommend that you update the BIOS file only coming from the same memory/ CPU configuration and BIOS version.

Profile Name

This item allows you to key in a profile name.

Save to Profile

This item allows you to save the current BIOS settings to the BIOS Flash, and create a profile. Key in a profile number from one to eight, press <Enter>, and then select **Yes**.

Load/Save Profile from/to USB Drive

This item allows you to load or save profile from your USB drive, load and save profile to your USB drive.

2.9.4 ASUS DRAM SPD Information

This item allows you to view the DRAM SPD information.

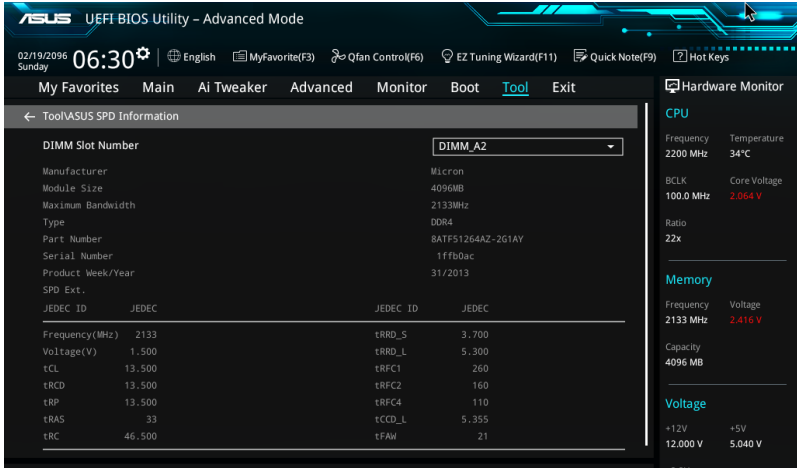

2.9.5 Graphics Card Information

This item displays the information about the graphics card installed in your system.

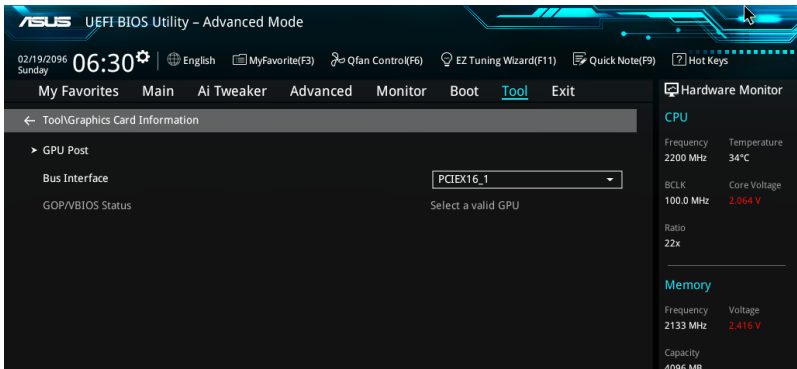

GPU Post

This item displays the information and recommended configuration for the PCIe slots that the graphics card is installed in your system.

Bus Interface

This item allows you to select the bus interface.

Configuration options: [PCIEX16_1] [PCIEX16_2]

2.10 Exit menu

The Exit menu items allow you to load the optimal default values for the BIOS items, and save or discard your changes to the BIOS items. You can access the EZ Mode from the Exit menu.

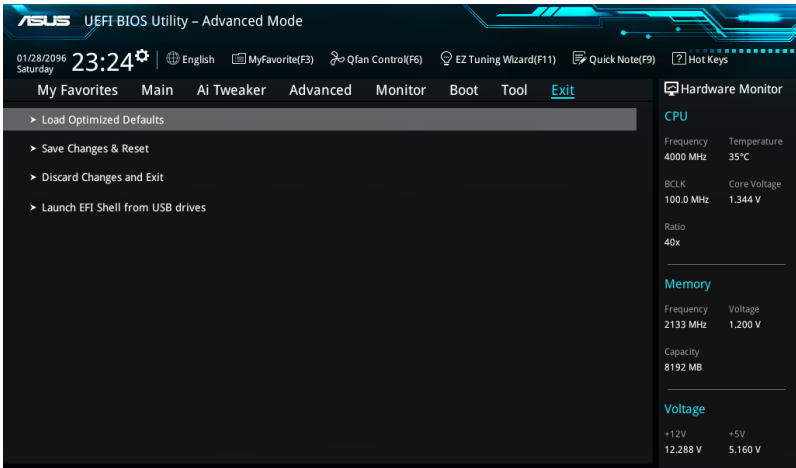

Load Optimized Defaults

This option allows you to load the default values for each of the parameters on the Setup menus. When you select this option or if you press <F5>, a confirmation window appears. Select **OK** to load the default values.

Save Changes & Reset

Once you are finished making your selections, choose this option from the Exit menu to ensure the values you selected are saved. When you select this option or if you press <F10>, a confirmation window appears. Select **OK** to save changes and exit.

Discard Changes & Exit

This option allows you to exit the Setup program without saving your changes. When you select this option or if you press <Esc>, a confirmation window appears. Select **Yes** to discard changes and exit.

Launch EFI Shell from filesystem device

This option allows you to attempt to launch the EFI Shell application (shellx64.efi) from one of the available filesystem devices.

2.11 Updating BIOS

The ASUS website publishes the latest BIOS versions to provide enhancements on system stability, compatibility, and performance. However, BIOS updating is potentially risky. If there is no problem using the current version of BIOS, DO NOT manually update the BIOS. Inappropriate BIOS updating may result to system's failure to boot. Carefully follow the instructions in this chapter to update your BIOS when necessary.



Visit <http://www.asus.com> to download the latest BIOS file for this motherboard.

The following utilities allow you to manage and update the motherboard BIOS setup program.

1. EZ Update: Updates the BIOS in Windows® environment.
2. ASUS EZ Flash 3: Updates the BIOS using a USB flash drive.
3. ASUS CrashFree BIOS 3: Restores the BIOS using the motherboard support DVD or a USB flash drive when the BIOS file fails or gets corrupted.

2.11.1 EZ Update

EZ Update is a utility that allows you to automatically update your motherboard's softwares, drivers, and the BIOS version easily. With this utility, you can also manually update the saved BIOS and select a boot logo when the system goes into POST.

Click to automatically update your motherboard driver, software and firmware

Click to search and select the BIOS file

Click to select a boot logo

Click to update the BIOS



EZ Update requires an Internet connection either through a network or an ISP (Internet Service Provider).

2.11.2 ASUS EZ Flash 3

ASUS EZ Flash 3 allows you to download and update to the latest BIOS through the Internet without having to use a bootable floppy disk or an OS-based utility.



Updating through the Internet varies per region and Internet conditions. Check your local Internet connection before updating through the Internet.

To update the BIOS by USB:

1. Enter the Advanced Mode of the BIOS setup program. Go to the Tool menu to select **ASUS EZ Flash Utility** and press <Enter>.
2. Insert the USB flash disk that contains the latest BIOS file to the USB port.
3. Select **by USB**.

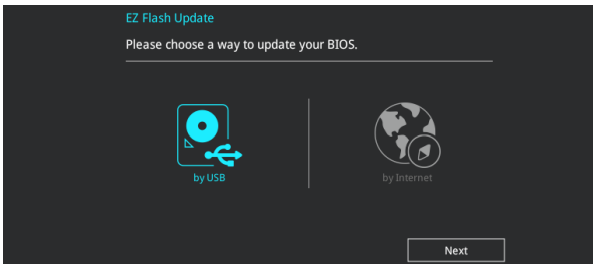

4. Press <Tab> to switch to the Drive field.
5. Press the Up/Down arrow keys to find the USB flash disk that contains the latest BIOS, and then press <Enter>.
6. Press <Tab> to switch to the Folder Info field.
7. Press the Up/Down arrow keys to find the BIOS file, and then press <Enter> to perform the BIOS update process. Reboot the system when the update process is done.

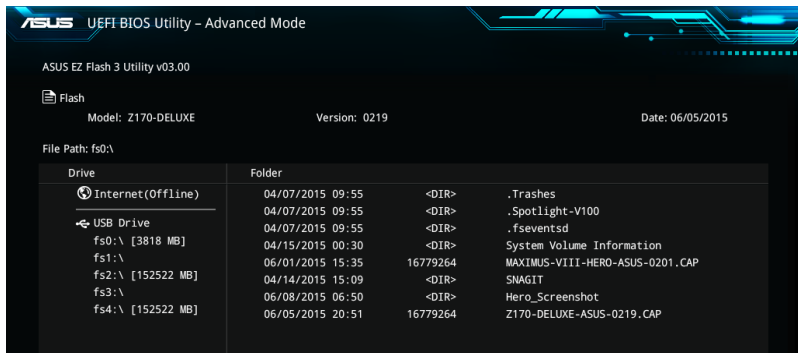



- This function can support devices such as a USB flash disk with FAT 32/16 format and single partition only.
- DO NOT shut down or reset the system while updating the BIOS to prevent system boot failure!



Ensure to load the BIOS default settings to ensure system compatibility and stability. Select the Load Optimized Defaults item under the Exit menu. See section 2.10 **Exit Menu** for details.

To update the BIOS by Internet:

1. Enter the Advanced Mode of the BIOS setup program. Go to the Tool menu to select **ASUS EZ Flash Utility** and press <Enter>.
2. Select **by Internet**.

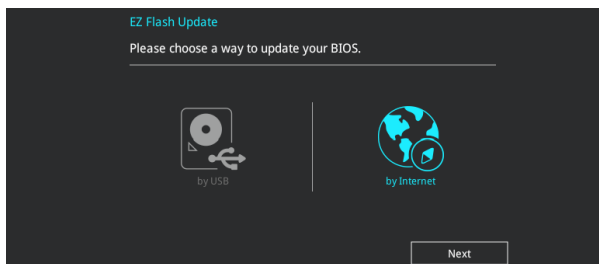

3. Press the Left/Right arrow keys to select an Internet connection method, and then press <Enter>.

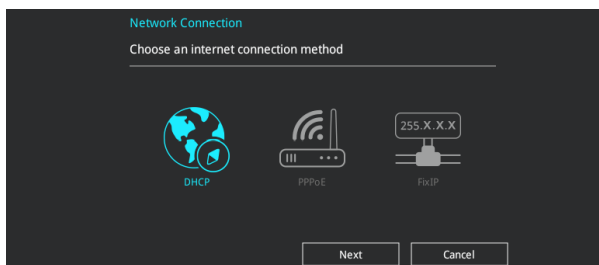

4. Follow the onscreen instructions to complete the update.
5. Reboot the system when the update process is done.



Ensure to load the BIOS default settings to ensure system compatibility and stability. Select the Load Optimized Defaults item under the Exit menu. See section 2.10 **Exit Menu** for details.

2.11.3 ASUS CrashFree BIOS 3

The ASUS CrashFree BIOS 3 utility is an auto recovery tool that allows you to restore the BIOS file when it fails or gets corrupted during the updating process. You can restore a corrupted BIOS file using the motherboard support DVD or a USB flash drive that contains the BIOS file.



The BIOS file in the motherboard support DVD may be older than the BIOS file published on the ASUS official website. If you want to use the newer BIOS file, download the file at <http://support.asus.com> and save it to a USB flash drive.

Recovering the BIOS

To recover the BIOS:

1. Turn on the system.
2. Insert the motherboard support DVD to the optical drive, or the USB flash drive containing the BIOS file to the USB port.
3. The utility automatically checks the devices for the BIOS file. When found, the utility reads the BIOS file and enters ASUS EZ Flash 2 automatically.
4. The system requires you to enter BIOS Setup to recover the BIOS setting. To ensure system compatibility and stability, we recommend that you press <F5> to load default BIOS values.



DO NOT shut down or reset the system while updating the BIOS! Doing so can cause system boot failure!

2.12 Installing an operating system



Motherboard settings and hardware options vary. The setup procedures presented in this chapter are for reference only. Refer to Windows® operating system documentation for detailed information.

2.12.1 Windows® 7 and USB 3.0 driver for 100 Series

Based on the chipset specification, the 100 series requires USB 3.0 drivers to be preloaded in order to use USB keyboard/mouse during Windows® 7 installation. This section is a guide on preloading USB 3.0 drivers and installing Windows® 7.

Method 1: Using SATA ODD & USB devices

Load USB 3.0 drivers using the ASUS support DVD and install Windows® 7 using a USB device.

Requirement:

- 1 x ASUS support DVD
- 1 x Windows® 7 installation source
- 1 x SATA ODD
- 1 x USB device (ODD or storage)



The USB storage device requires 8 GB or more capacity. It is recommended to format the storage device before use.

1. Insert the Windows® 7 installation DVD into a USB ODD, or copy all files on the Windows® 7 installation DVD to a USB storage device on a working system.
2. Connect the USB ODD or USB storage device to your 100 series platform.
3. Insert the ASUS support DVD into a SATA ODD on your 100 series platform.
4. Power on your system and press F8 during POST (Power-On Self Test) to enter the boot screen.

5. Select the USB ODD or USB storage device as the boot device.

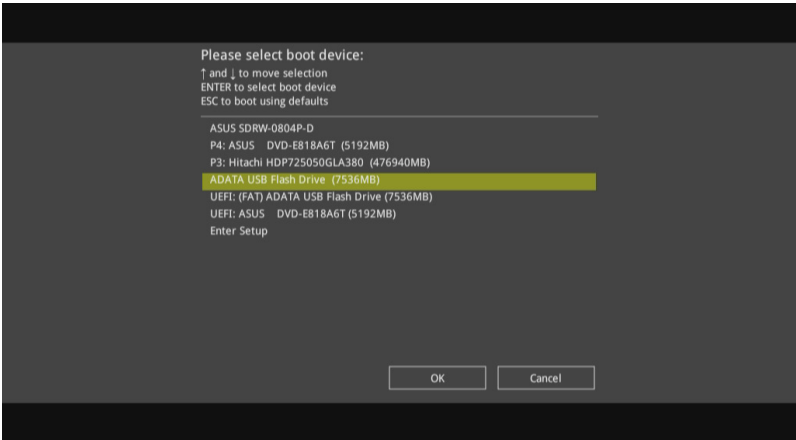

6. The USB 3.0 driver will be loaded automatically during installation startup.

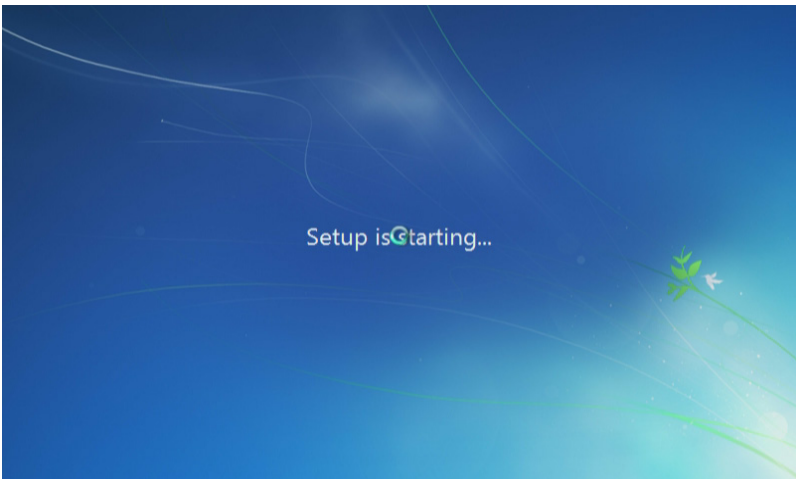

The "Setup is starting..." screen will show up if the USB 3.0 driver is loaded correctly.

7. Follow the onscreen instructions to complete the Windows® 7 installation.

Method 2: Using a modified Windows® 7 ISO

Load USB 3.0 drivers and install Windows® 7 using a modified Windows® 7 installation DVD.

Requirement:

- 1 x ASUS support DVD
- 1 x Windows® 7 installation source
- 1 x Working system (PC or notebook)
- 1 x SATA ODD

1. On your working system, create an ISO image file of the Windows® 7 installation source using a third-party ISO software.
2. Copy both "Auto_Unattend.xml" and "Auto_Unattend" folder from the root directory of the ASUS supporting DVD to your system.
3. Edit the ISO file and add both "Auto_Unattend.xml" and "Auto_Unattend" folder into the ISO file.
4. Burn this ISO file onto an empty DVD to create a modified Windows® 7 installation DVD.
5. Insert the modified Windows® 7 installation DVD into an ODD on your 100 series platform.
6. Power on your system and press F8 during POST (Power-On Self Test) to enter the boot screen.
7. Select the ODD as the boot device.
8. The USB 3.0 driver will be loaded automatically during installation startup.



The "Setup is starting..." screen will show up if the USB 3.0 driver is loaded correctly.

9. Follow the onscreen instructions to complete the Windows® 7 installation.

Method 3: Using ASUS EZ Installer

Use the ASUS EZ Installer to create a modified Windows® 7 installation source.

Requirement:

- 1 x ASUS support DVD
 - 1 x Windows® 7 installation DVD
 - 1 x Working system (PC or notebook)
 - 1 x SATA ODD
 - 1 x USB storage device (8 GB or more)
1. Insert the Windows® 7 installation DVD.
 2. Launch the ASUS EZ Installer located on the ASUS support DVD.
 3. Select a method of creating a modified Windows® 7 installation file:
 - Windows® 7 OS disk to USB storage device
 - Select **Windows 7 OS disk to USB storage device** then click **Next**.

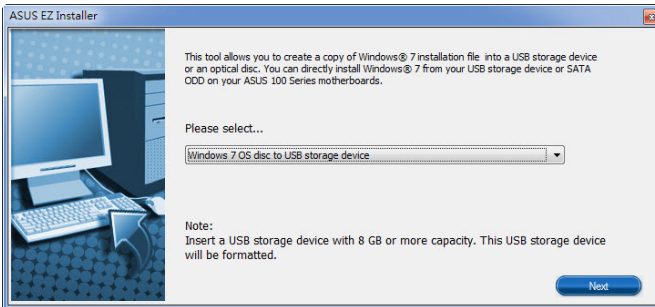

- Check **I agree** and then click **Next**.

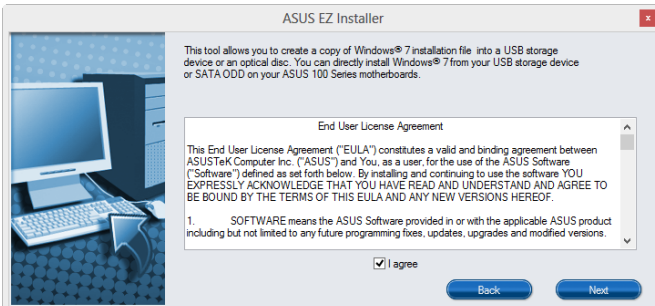

- Select the source of the Windows® 7 installation disk then click **Next**.

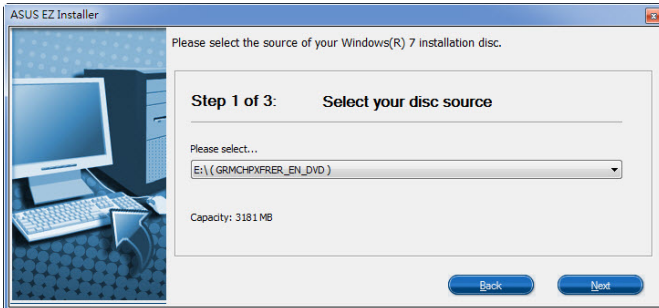

- Select the USB storage device and click **next**.

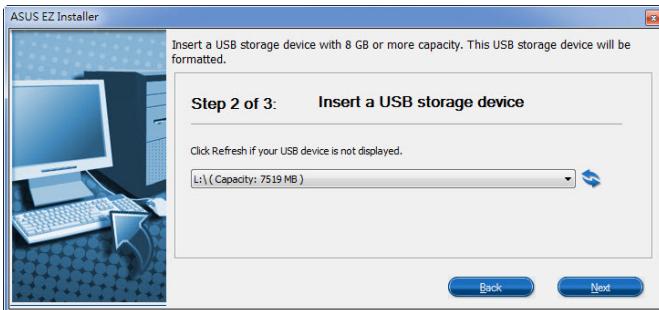

Click the refresh icon  if the USB storage device is not displayed.

- Click **Yes** to clear the contents on the USB storage device and create a bootable USB device.



Make sure to backup contents on the USB storage device, as it will be formatted.

- Once completed, click **OK** to finish.

- Windows® 7 OS disk to ISO file
 - Select **Windows 7 OS disk to ISO file** then click **Next**.

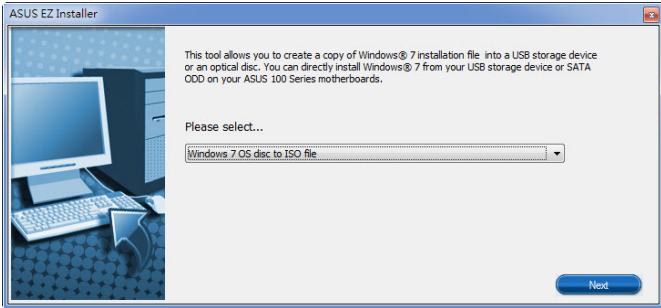

- Check **I agree** and then click **Next**.

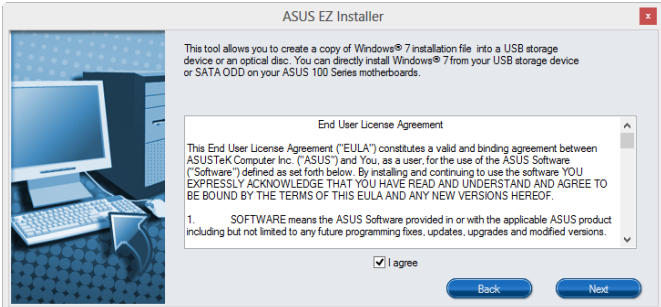

- Select the source of the Windows® 7 installation disk then click **Next**.

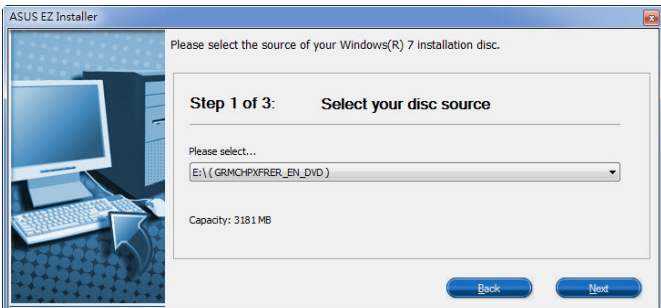

- Select the folder to save the modified Windows® 7 installation ISO file and click **Next**.

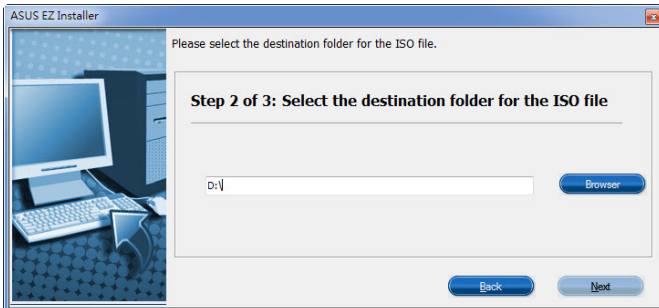

- Once completed, click OK to finish.
 - Burn this ISO file onto an empty DVD to create a modified Windows® 7 installation DVD.
4. Insert the modified Windows® 7 installation DVD into an ODD or connect the USB storage device with modified Windows® 7 installation files onto your 100 series platform.
 5. Power on your system and press F8 during POST (Power-On Self Test) to enter the boot screen.
 6. Select the ODD or USB storage device as the boot device.
 7. The USB 3.0 driver will be loaded automatically during installation startup.



The "Setup is starting..." screen will show up if the USB 3.0 driver is loaded correctly.

8. Follow the onscreen instructions to complete the Windows® 7 installation.

Appendices

Notices

Federal Communications Commission Statement

This device complies with Part 15 of the FCC Rules. Operation is subject to the following two conditions:

- This device may not cause harmful interference.
- This device must accept any interference received including interference that may cause undesired operation.

This equipment has been tested and found to comply with the limits for a Class B digital device, pursuant to Part 15 of the FCC Rules. These limits are designed to provide reasonable protection against harmful interference in a residential installation. This equipment generates, uses and can radiate radio frequency energy and, if not installed and used in accordance with manufacturer's instructions, may cause harmful interference to radio communications. However, there is no guarantee that interference will not occur in a particular installation. If this equipment does cause harmful interference to radio or television reception, which can be determined by turning the equipment off and on, the user is encouraged to try to correct the interference by one or more of the following measures:

- Reorient or relocate the receiving antenna.
- Increase the separation between the equipment and receiver.
- Connect the equipment to an outlet on a circuit different from that to which the receiver is connected.
- Consult the dealer or an experienced radio/TV technician for help.



The use of shielded cables for connection of the monitor to the graphics card is required to assure compliance with FCC regulations. Changes or modifications to this unit not expressly approved by the party responsible for compliance could void the user's authority to operate this equipment.

IC: Canadian Compliance Statement

Complies with the Canadian ICES-003 Class B specifications. This device complies with RSS 210 of Industry Canada. This Class B device meets all the requirements of the Canadian interference-causing equipment regulations.

This device complies with Industry Canada license exempt RSS standard(s). Operation is subject to the following two conditions: (1) this device may not cause interference, and (2) this device must accept any interference, including interference that may cause undesired operation of the device.

Cet appareil numérique de la Classe B est conforme à la norme NMB-003 du Canada. Cet appareil numérique de la Classe B respecte toutes les exigences du Règlement sur le matériel brouilleur du Canada.

Cet appareil est conforme aux normes CNR exemptes de licence d'Industrie Canada. Le fonctionnement est soumis aux deux conditions suivantes :

- (1) cet appareil ne doit pas provoquer d'interférences et
- (2) cet appareil doit accepter toute interférence, y compris celles susceptibles de provoquer un fonctionnement non souhaité de l'appareil.

Canadian Department of Communications Statement

This digital apparatus does not exceed the Class B limits for radio noise emissions from digital apparatus set out in the Radio Interference Regulations of the Canadian Department of Communications.

This class B digital apparatus complies with Canadian ICES-003.

VCCI: Japan Compliance Statement

Class B ITE

この装置は、クラスB情報技術装置です。この装置は、家庭環境で使用することを目的としていますが、この装置がラジオやテレビジョン受信機に近接して使用されると、受信障害を引き起こすことがあります。

取扱説明書に従って正しい取り扱いをして下さい。

VCCI-B

KC: Korea Warning Statement

B급 기기 (가정용 방송통신기자재)

이 기기는 가정용(B급) 전자파적합기기로서 주로 가정에서 사용하는 것을 목적으로 하며, 모든 지역에서 사용할 수 있습니다.

REACH

Complying with the REACH (Registration, Evaluation, Authorisation, and Restriction of Chemicals) regulatory framework, we published the chemical substances in our products at ASUS REACH website at <http://csr.asus.com/english/REACH.htm>.



DO NOT throw the motherboard in municipal waste. This product has been designed to enable proper reuse of parts and recycling. This symbol of the crossed out wheeled bin indicates that the product (electrical and electronic equipment) should not be placed in municipal waste. Check local regulations for disposal of electronic products.



DO NOT throw the mercury-containing button cell battery in municipal waste. This symbol of the crossed out wheeled bin indicates that the battery should not be placed in municipal waste.

ASUS Recycling/Takeback Services

ASUS recycling and takeback programs come from our commitment to the highest standards for protecting our environment. We believe in providing solutions for you to be able to responsibly recycle our products, batteries, other components as well as the packaging materials. Please go to <http://csr.asus.com/english/Takeback.htm> for detailed recycling information in different regions.

Google™ License Terms

Copyright© 2015 Google Inc. All Rights Reserved.

Licensed under the Apache License, Version 2.0 (the “License”); you may not use this file except in compliance with the License. You may obtain a copy of the License at:

<http://www.apache.org/licenses/LICENSE-2.0>

Unless required by applicable law or agreed to in writing, software distributed under the License is distributed on an “AS IS” BASIS, WITHOUT WARRANTIES OR CONDITIONS OF ANY KIND, either express or implied.

See the License for the specific language governing permissions and limitations under the License.

English AsusTek Inc. hereby declares that this device is in compliance with the essential requirements and other relevant provisions of CE Directives. Please see the CE Declaration of Conformity for more details.

Français AsusTek Inc. déclare par la présente que cet appareil est conforme aux critères essentiels et autres clauses pertinentes des directives européennes. Veuillez consulter la déclaration de conformité CE pour plus d'informations.

Deutsch AsusTek Inc. erklärt hiermit, dass dieses Gerät mit den wesentlichen Anforderungen und anderen relevanten Bestimmungen der CE-Richtlinien übereinstimmt. Weitere Einzelheiten entnehmen Sie bitte der CE-Konformitätserklärung.

Italiano AsusTek Inc. con la presente dichiara che questo dispositivo è conforme ai requisiti essenziali e alle altre disposizioni pertinenti alle direttive CE. Per maggiori informazioni fate riferimento alla dichiarazione di conformità CE.

Компанија ASUS заявљује, да је ово уређај у складу са основним захтеvима и другим релевантним одредбама CE директива. Молимо вас, погледajte CE Декларацију о усклађености за више детаља.

Български С настоящото AsusTek Inc. декларира, че това устройство е в съответствие със съществениите изисквания и другите приложими постановления на директивите CE. Вижте CE декларацията за съвместимост за повече информация.

Hrvatski AsusTek Inc. ovim izjavljuje da je ovaj uređaj sukladan s bitnim zahtjevima i ostalim odgovarajućim odredbama CE direktiva. Više pojedinosti potražite u CE izjavi o sukladnosti.

Čeština Společnost AsusTek Inc. tímto prohlašuje, že toto zařízení splňuje základní požadavky a další příslušná ustanovení směrnice CE. Další podrobnosti viz Prohlášení o shodě CE.

Dansk AsusTek Inc. Erklærer hermed, at denne enhed er i overensstemmelse med hovedkravene and andre relevante bestemmelser i CE-direktiverne. Du kan læse mere i CE-overensstemmelseserklæring.

Nederlands AsusTek Inc. verklaart hierbij dat dit apparaat compatibel is met de essentiële vereisten en andere relevante bepalingen van CE-richtlijnen. Raadpleeg de CE-verklaring van conformiteit voor meer details.

Esti Käesolevaga kinnitab AsusTek Inc., et see seade vastab CE direktiivide oluliste nõuetele ja teistele asjakohastele sätetele. Vt üksikasju CE vastavusdeklaratsioonis.

Suomi AsusTek Inc. vakuuttaa täten, että tämä laite on CE-direktiivien olennaisten vaatimusten ja muiden asiaan kuuluvien lisäysten mukainen. Katso lisätietoja CE-vaatimustenmukaisuusvakuutuksesta.

Ελληνικά Με το παρόν η AsusTek Inc. δηλώνει ότι αυτή η συσκευή συμμορφώνεται με τις θεμελιώδεις απαιτήσεις και άλλες σχετικές διατάξεις των Οδηγιών της ΕΕ. Για περισσότερες λεπτομέρειες ανατρέξτε στην Δήλωση Συμμόρφωσης ΕΕ.

Magyar Az AsusTek Inc. ezennel kijelenti, hogy a készülék megfelel a CE-irányelvek alapvető követelményeinek és ide vonatkozó egyéb rendelkezéseinek. További részletekért tekintse meg a CE-megfeleléségi nyilatkozatot.

Latviski Līdz ar šo AsusTek Inc. paziņo, ka šī ierīce atbilst būtiskajām prasībām un citiem saistošajiem nosacījumiem, kas norādīti CE direktīvā. Lai uzzinātu vairāk, skatiet CE Atbilstības deklarāciju.

Lietuvių Šiuo dokumentu bendrovė „AsusTek Inc.“ pareiškia, kad šis įrenginys atitinka pagrindinius CE direktyvų reikalavimus ir kitas susijusias nuostatas. Daugiau informacijos rasite CE atitikties deklaracijoje.

Norsk AsusTek Inc. erklærer herved at denne enheten er i samsvar med hovedsaklige krav og andre relevante forskrifter i CE-direktiver. Du finner mer informasjon i CE-samsvarserklæringen.

Polski Niniejszym AsusTek Inc. deklaruje, że to urządzenie jest zgodne z istotnymi wymaganiami oraz innymi powiązanymi zaleceniami Dyrektyw CE. W celu uzyskania szczegółów, sprawdź Deklarację zgodności CE.

Português A AsusTek Inc. declara que este dispositivo está em conformidade com os requisitos essenciais e outras disposições relevantes das Diretivas da CE. Para mais detalhes, consulte a Declaração de Conformidade CE.

Română Prin prezenta, AsusTek Inc. declară faptul că acest dispozitiv respectă cerințele esențiale și alte prevederi relevante ale directivelor CE. Pentru mai multe detalii, consultați declarația de conformitate CE.

Srpski AsusTek Inc. ovim izjavljuje da je ovaj uređaj u saglasnosti sa ključnim zahtjevima i drugim relevantnim odredbama CE Direktiva. Molimo vas, pogledajte CE Deklaraciju o usklađenosti za više detalja.

Slovensky Spoločnosť AsusTek Inc. týmto prehlasuje, že toto zariadenie vyhovuje príslušným požiadavkám a ďalším súvisiacim ustanoveniam smerníc ES. Viac podrobností si pozrite v prehlásení o zhode ES.

Slovenščina AsusTek Inc. tukaj izjavlja, da je ta naprava skladna s temeljnimi zahtevami in drugimi relevantnimi določili direktiv CE. Za več informacij glejte izjavo CE o skladnosti.

Español Por la presente, AsusTek Inc. declara que este dispositivo cumple los requisitos básicos y otras disposiciones relevantes de las directivas de la CE. Consulte la Declaración de conformidad de la CE para obtener más detalles.

Svenska AsusTek Inc. förklarar härmed att denna enhet är i överensstämmelse med de grundläggande kraven och andra relevanta bestämmelser i CE-direktiven. Se CE-försäkran om överensstämmelse för mer information.

Українська AsusTek Inc. заявляє, що цей пристрій відповідає основним вимогам відповідних Директив ЄС. Будь ласка, див. більше подробиць у Декларації відповідності нормам ЄС.

Türkçe AsusTek Inc., bu aygıtın temel gereksinimleri ve CE Yönergelerinin diğer ilgili koşullarına uyumlu olduğunu beyan eder. Daha fazla ayrıntı için lütfen CE Uygunluk Beyanına bakın.

Bosanski AsusTek Inc. ovim potvrđuje da je ovaj uređaj usklađen s osnovnim zahtjevima i drugim relevantnim propisima Direktiva EK. Za više informacija molimo pogledajte Deklaraciju o usklađenosti EK.

ASUS contact information

ASUSTeK COMPUTER INC.

Address 15 Li-Te Road, Peitou, Taipei, Taiwan 11259
Telephone +886-2-2894-3447
Fax +886-2-2890-7798
E-mail info@asus.com.tw
Web site www.asus.com/

Technical Support

Telephone +86-21-38429911
Fax +86-21-5866-8722, ext. 9101#
Online support <http://www.asus.com/tw/support/>

ASUS COMPUTER INTERNATIONAL (America)

Address 800 Corporate Way, Fremont, CA 94539, USA
Telephone +1-510-739-3777
Fax +1-510-608-4555
Web site <http://www.asus.com/us/>

Technical Support

Support fax +1-812-284-0883
Telephone +1-812-282-2787
Online support <http://www.service.asus.com/>

ASUS COMPUTER GmbH (Germany and Austria)

Address Harkort Str. 21-23, D-40880 Ratingen, Germany
Fax +49-2102-959911
Web site <http://www.asus.com/de>
Online contact <http://eu-rma.asus.com/sales>

Technical Support

Telephone +49-1805-010923
Support Fax +49-2102-9599-11
Online support <http://www.asus.com/de/support/>

DECLARATION OF CONFORMITY

Per FCC Part 2, Section 2.1077(a)



Responsible Party Name: **Asus Computer International**
Address: **800 Corporate Way, Fremont, CA 94539.**

Phone/Fax No: **(510)739-3777/(510)608-4555**
hereby declares that the product

Product Name : Motherboard
Model Number : Z170-E

Conforms to the following specifications:

- FCC Part 15, Subpart B, Unintentional Radiators

Supplementary Information:

This device complies with part 15 of the FCC Rules. Operation is subject to the following two conditions: (1) This device may not cause harmful interference, and (2) this device must accept any interference received, including interference that may cause undesired operation.

Representative Person's Name : Steve Chang / President

Signature :

Date : Oct. 01, 2015

Ver. 140331

EC Declaration of Conformity



We, the undersigned,

Manufacturer: **ASUSTEK COMPUTER INC.**
Address: **4F, No. 150, LITE Rd., PEITOU, TAIPEI 112, TAIWAN**
Authorized representative in Europe: **ASUS COMPUTER GmbH**
Address, City: **HARKORT STR. 2123, 40880 RATINGEN**
Country: **GERMANY**

declare the following apparatus:

Product name : _____
Model name : **Z170-E**

conform with the essential requirements of the following directives:

2004/108/EC-EMC Directive
 EN 55022:2010/A2:2011
 EN 55013:2001/A1:2003/A2:2006
 EN 55020:2007/A1:2011

1989/50/EC-R&TTE Directive
 EN 300 328 V1.8.1 (2012:06)
 EN 300 440-1 V1.9.1 (2010:08)
 EN 300 440-2 V1.9.1 (2010:08)
 EN 301 811 V10.0 (2010:03)
 EN 301 887 V1.3 (2005:11)
 EN 301 889-1 V1.5.2 (2011:05)
 EN 301 889-2 V1.5.2 (2011:05)
 EN 301 889-3 V1.5.2 (2011:05)
 EN 301 889-4 V1.5.2 (2011:05)
 EN 301 889-5 V1.5.2 (2011:05)
 EN 302 540-1 V1.1 (2009:01)
 EN 302 540-2 V1.1 (2009:01)
 EN 302 540-3 V1.3 (2007:09)
 EN 302 540-4 V1.3 (2007:09)
 EN 302 540-5 V1.1 (2005:07)
 EN 302 540-6 V1.1 (2005:07)
 EN 302 540-7 V1.1 (2005:07)
 EN 302 540-8 V1.1 (2005:07)
 EN 302 540-9 V1.1 (2005:07)
 EN 302 540-10 V1.1 (2005:07)
 EN 302 540-11 V1.1 (2005:07)
 EN 302 540-12 V1.1 (2005:07)
 EN 302 540-13 V1.1 (2005:07)
 EN 302 540-14 V1.1 (2005:07)
 EN 302 540-15 V1.1 (2005:07)
 EN 302 540-16 V1.1 (2005:07)
 EN 302 540-17 V1.1 (2005:07)
 EN 302 540-18 V1.1 (2005:07)
 EN 302 540-19 V1.1 (2005:07)
 EN 302 540-20 V1.1 (2005:07)
 EN 302 540-21 V1.1 (2005:07)
 EN 302 540-22 V1.1 (2005:07)
 EN 302 540-23 V1.1 (2005:07)
 EN 302 540-24 V1.1 (2005:07)
 EN 302 540-25 V1.1 (2005:07)
 EN 302 540-26 V1.1 (2005:07)
 EN 302 540-27 V1.1 (2005:07)
 EN 302 540-28 V1.1 (2005:07)
 EN 302 540-29 V1.1 (2005:07)
 EN 302 540-30 V1.1 (2005:07)
 EN 302 540-31 V1.1 (2005:07)
 EN 302 540-32 V1.1 (2005:07)
 EN 302 540-33 V1.1 (2005:07)
 EN 302 540-34 V1.1 (2005:07)
 EN 302 540-35 V1.1 (2005:07)
 EN 302 540-36 V1.1 (2005:07)
 EN 302 540-37 V1.1 (2005:07)
 EN 302 540-38 V1.1 (2005:07)
 EN 302 540-39 V1.1 (2005:07)
 EN 302 540-40 V1.1 (2005:07)
 EN 302 540-41 V1.1 (2005:07)
 EN 302 540-42 V1.1 (2005:07)
 EN 302 540-43 V1.1 (2005:07)
 EN 302 540-44 V1.1 (2005:07)
 EN 302 540-45 V1.1 (2005:07)
 EN 302 540-46 V1.1 (2005:07)
 EN 302 540-47 V1.1 (2005:07)
 EN 302 540-48 V1.1 (2005:07)
 EN 302 540-49 V1.1 (2005:07)
 EN 302 540-50 V1.1 (2005:07)
 EN 302 540-51 V1.1 (2005:07)
 EN 302 540-52 V1.1 (2005:07)
 EN 302 540-53 V1.1 (2005:07)
 EN 302 540-54 V1.1 (2005:07)
 EN 302 540-55 V1.1 (2005:07)
 EN 302 540-56 V1.1 (2005:07)
 EN 302 540-57 V1.1 (2005:07)
 EN 302 540-58 V1.1 (2005:07)
 EN 302 540-59 V1.1 (2005:07)
 EN 302 540-60 V1.1 (2005:07)
 EN 302 540-61 V1.1 (2005:07)
 EN 302 540-62 V1.1 (2005:07)
 EN 302 540-63 V1.1 (2005:07)
 EN 302 540-64 V1.1 (2005:07)
 EN 302 540-65 V1.1 (2005:07)
 EN 302 540-66 V1.1 (2005:07)
 EN 302 540-67 V1.1 (2005:07)
 EN 302 540-68 V1.1 (2005:07)
 EN 302 540-69 V1.1 (2005:07)
 EN 302 540-70 V1.1 (2005:07)
 EN 302 540-71 V1.1 (2005:07)
 EN 302 540-72 V1.1 (2005:07)
 EN 302 540-73 V1.1 (2005:07)
 EN 302 540-74 V1.1 (2005:07)
 EN 302 540-75 V1.1 (2005:07)
 EN 302 540-76 V1.1 (2005:07)
 EN 302 540-77 V1.1 (2005:07)
 EN 302 540-78 V1.1 (2005:07)
 EN 302 540-79 V1.1 (2005:07)
 EN 302 540-80 V1.1 (2005:07)
 EN 302 540-81 V1.1 (2005:07)
 EN 302 540-82 V1.1 (2005:07)
 EN 302 540-83 V1.1 (2005:07)
 EN 302 540-84 V1.1 (2005:07)
 EN 302 540-85 V1.1 (2005:07)
 EN 302 540-86 V1.1 (2005:07)
 EN 302 540-87 V1.1 (2005:07)
 EN 302 540-88 V1.1 (2005:07)
 EN 302 540-89 V1.1 (2005:07)
 EN 302 540-90 V1.1 (2005:07)
 EN 302 540-91 V1.1 (2005:07)
 EN 302 540-92 V1.1 (2005:07)
 EN 302 540-93 V1.1 (2005:07)
 EN 302 540-94 V1.1 (2005:07)
 EN 302 540-95 V1.1 (2005:07)
 EN 302 540-96 V1.1 (2005:07)
 EN 302 540-97 V1.1 (2005:07)
 EN 302 540-98 V1.1 (2005:07)
 EN 302 540-99 V1.1 (2005:07)
 EN 302 540-100 V1.1 (2005:07)

2006/95/EC-LVD Directive
 EN 60950-1:2006 /A12: 2011
 EN 60950-1:2006 /A2: 2013

2006/125/EC-ErP Directive
 Regulation (EC) No. 1275/2008
 Regulation (EC) No. 642/2009

2011/65/EU-REACHS Directive
 Regulation (EC) No. 2792/2009
 Regulation (EU) No. 617/2013

Ver. 150208



(EC conformity marking)

Position : **CEO**
Name : **Jerry Shen**

Signature : _____

Declaration Date: **01/10/2015**
Year to begin affixing CE marking: **2015**