

**Z170-WS**

**ASUS®**

**Motherboard**

**Copyright© 2017 ASUSTeK COMPUTER INC. All Rights Reserved.**

No part of this manual, including the products and software described in it, may be reproduced, transmitted, transcribed, stored in a retrieval system, or translated into any language in any form or by any means, except documentation kept by the purchaser for backup purposes, without the express written permission of ASUSTeK COMPUTER INC. ("ASUS").

Product warranty or service will not be extended if: (1) the product is repaired, modified or altered, unless such repair, modification of alteration is authorized in writing by ASUS; or (2) the serial number of the product is defaced or missing.

ASUS PROVIDES THIS MANUAL "AS IS" WITHOUT WARRANTY OF ANY KIND, EITHER EXPRESS OR IMPLIED, INCLUDING BUT NOT LIMITED TO THE IMPLIED WARRANTIES OR CONDITIONS OF MERCHANTABILITY OR FITNESS FOR A PARTICULAR PURPOSE. IN NO EVENT SHALL ASUS, ITS DIRECTORS, OFFICERS, EMPLOYEES OR AGENTS BE LIABLE FOR ANY INDIRECT, SPECIAL, INCIDENTAL, OR CONSEQUENTIAL DAMAGES (INCLUDING DAMAGES FOR LOSS OF PROFITS, LOSS OF BUSINESS, LOSS OF USE OR DATA, INTERRUPTION OF BUSINESS AND THE LIKE), EVEN IF ASUS HAS BEEN ADVISED OF THE POSSIBILITY OF SUCH DAMAGES ARISING FROM ANY DEFECT OR ERROR IN THIS MANUAL OR PRODUCT.

SPECIFICATIONS AND INFORMATION CONTAINED IN THIS MANUAL ARE FURNISHED FOR INFORMATIONAL USE ONLY, AND ARE SUBJECT TO CHANGE AT ANY TIME WITHOUT NOTICE, AND SHOULD NOT BE CONSTRUED AS A COMMITMENT BY ASUS. ASUS ASSUMES NO RESPONSIBILITY OR LIABILITY FOR ANY ERRORS OR INACCURACIES THAT MAY APPEAR IN THIS MANUAL, INCLUDING THE PRODUCTS AND SOFTWARE DESCRIBED IN IT.

Products and corporate names appearing in this manual may or may not be registered trademarks or copyrights of their respective companies, and are used only for identification or explanation and to the owners' benefit, without intent to infringe.

**Offer to Provide Source Code of Certain Software**

This product contains copyrighted software that is licensed under the General Public License ("GPL"), under the Lesser General Public License Version ("LGPL") and/or other Free Open Source Software Licenses. Such software in this product is distributed without any warranty to the extent permitted by the applicable law. Copies of these licenses are included in this product.

Where the applicable license entitles you to the source code of such software and/or other additional data, you may obtain it for a period of three years after our last shipment of the product, either

(1) for free by downloading it from <https://www.asus.com/support/>

or

(2) for the cost of reproduction and shipment, which is dependent on the preferred carrier and the location where you want to have it shipped to, by sending a request to:

ASUSTeK Computer Inc.  
Legal Compliance Dept.  
15 Li Te Rd.,  
Beitou, Taipei 112  
Taiwan

In your request please provide the name, model number and version, as stated in the About Box of the product for which you wish to obtain the corresponding source code and your contact details so that we can coordinate the terms and cost of shipment with you.

The source code will be distributed WITHOUT ANY WARRANTY and licensed under the same license as the corresponding binary/object code.

This offer is valid to anyone in receipt of this information.

ASUSTeK is eager to duly provide complete source code as required under various Free Open Source Software licenses. If however you encounter any problems in obtaining the full corresponding source code we would be much obliged if you give us a notification to the email address [gpl@asus.com](mailto:gpl@asus.com), stating the product and describing the problem (please DO NOT send large attachments such as source code archives, etc. to this email address).

# Contents

Safety information.....	vii
About this guide.....	viii
Z170-WS specifications summary.....	x
Package contents.....	xvi
Installation tools and components.....	xvii

## Chapter 1: Product Introduction

<b>1.1</b>	<b>Special features.....</b>	<b>1-1</b>
1.1.1	Product highlights.....	1-1
1.1.2	ASUS-exclusive workstation features.....	1-2
1.1.3	Other special features.....	1-2
<b>1.2</b>	<b>Motherboard overview.....</b>	<b>1-3</b>
1.2.1	Before you proceed.....	1-3
1.2.2	Motherboard layout.....	1-4
1.2.3	Central Processing Unit (CPU).....	1-6
1.2.4	System memory.....	1-7
1.2.5	Expansion slots.....	1-9
1.2.6	Onboard buttons and switches.....	1-12
1.2.7	Jumpers.....	1-17
1.2.8	Onboard LEDs.....	1-18
1.2.9	Internal connectors.....	1-25

## Chapter 2: Basic Installation

<b>2.1</b>	<b>Building your PC system.....</b>	<b>2-1</b>
2.1.1	Motherboard installation.....	2-1
2.1.2	CPU installation.....	2-3
2.1.3	CPU heatsink and fan assembly installation.....	2-5
2.1.4	DIMM installation.....	2-7
2.1.5	ATX Power connection.....	2-8
2.1.6	SATA device connection.....	2-9
2.1.7	Front I/O connector.....	2-10
2.1.8	Expansion Card installation.....	2-11
<b>2.2</b>	<b>BIOS update utility.....</b>	<b>2-12</b>
<b>2.3</b>	<b>Motherboard rear and audio connections.....</b>	<b>2-14</b>
2.3.1	Rear I/O connection.....	2-14
2.3.2	Audio I/O connections.....	2-16
<b>2.4</b>	<b>Starting up for the first time.....</b>	<b>2-18</b>
<b>2.5</b>	<b>Turning off the computer.....</b>	<b>2-19</b>

# Contents

## Chapter 3: BIOS Setup

<b>3.1</b>	<b>Knowing BIOS</b> .....	<b>3-1</b>
<b>3.2</b>	<b>BIOS setup program</b> .....	<b>3-2</b>
3.2.1	EZ Mode.....	3-3
3.2.2	Advanced Mode .....	3-4
3.2.3	QFan Control.....	3-7
3.2.4	EZ Tuning Wizard .....	3-9
<b>3.3</b>	<b>My Favorites</b> .....	<b>3-12</b>
<b>3.4</b>	<b>Main menu</b> .....	<b>3-14</b>
<b>3.5</b>	<b>Ai Tweaker menu</b> .....	<b>3-16</b>
<b>3.6</b>	<b>Advanced menu</b> .....	<b>3-31</b>
3.6.1	CPU Configuration .....	3-32
3.6.2	Platform Misc Configuration.....	3-34
3.6.3	System Agent (SA) Configuration .....	3-36
3.6.4	PCH Configuration .....	3-37
3.6.5	PCH Storage Configuration.....	3-38
3.6.6	USB Configuration .....	3-40
3.6.7	Network Stack Configuration.....	3-41
3.6.8	Onboard Devices Configuration.....	3-41
3.6.9	APM Configuration.....	3-44
3.6.10	HDD/SSD SMART Information .....	3-45
3.6.11	Intel(R) Thunderbolt Configuration.....	3-45
<b>3.7</b>	<b>Monitor menu</b> .....	<b>3-46</b>
<b>3.8</b>	<b>Boot menu</b> .....	<b>3-52</b>
<b>3.9</b>	<b>Tool menu</b> .....	<b>3-57</b>
3.9.1	ASUS EZ Flash 3 Utility .....	3-57
3.9.2	Secure Erase .....	3-57
3.9.3	ASUS Overclocking Profile .....	3-59
3.9.4	ASUS SPD Information .....	3-60
3.9.5	Graphics Card Information.....	3-60
<b>3.10</b>	<b>Exit menu</b> .....	<b>3-61</b>
<b>3.11</b>	<b>Updating BIOS</b> .....	<b>3-62</b>
3.11.1	EZ Update.....	3-62
3.11.2	ASUS EZ Flash 3.....	3-63
3.11.3	ASUS CrashFree BIOS 3.....	3-65

# Contents

## Chapter 4: Software Support

<b>4.1</b>	<b>Installing an operating system</b> .....	<b>4-1</b>
4.1.1	Windows® 7 and USB 3.0 driver for 100 Series .....	4-1
<b>4.2</b>	<b>Support DVD information</b> .....	<b>4-8</b>
4.2.1	Running the support DVD .....	4-8
4.2.2	Obtaining the software manuals.....	4-9
<b>4.3</b>	<b>Software information</b> .....	<b>4-10</b>
<b>4.4</b>	<b>AI Suite 3</b> .....	<b>4-10</b>
4.4.1	Ai Charger+.....	4-14
4.4.2	USB 3.1 Boost.....	4-15
4.4.3	EZ Update.....	4-16
4.4.4	USB BIOS Flashback.....	4-18
4.4.5	Push Notice.....	4-20
4.4.6	System Information .....	4-23
4.4.7	Key Express.....	4-25
<b>4.5</b>	<b>Audio configurations</b> .....	<b>4-27</b>

## Chapter 5: RAID Support

<b>5.1</b>	<b>RAID configurations</b> .....	<b>5-1</b>
5.1.1	RAID definitions .....	5-1
5.1.2	Installing Serial ATA hard disks .....	5-2
5.1.3	Setting the RAID item in BIOS .....	5-2
5.1.4	Intel® Rapid Storage Technology Option ROM utility.....	5-3
<b>5.2</b>	<b>Creating a RAID driver disk</b> .....	<b>5-7</b>
5.2.1	Creating a RAID driver disk without entering the OS.....	5-7
5.2.2	Creating a RAID driver disk in Windows®.....	5-8
5.2.3	Installing the RAID driver during Windows® OS installation.....	5-8

## Chapter 6: Multi GPU support

<b>6.1</b>	<b>AMD® CrossFireX™ technology</b> .....	<b>6-1</b>
6.1.1	Requirements.....	6-1
6.1.2	Before you begin .....	6-1
6.1.3	Installing two CrossFireX™ graphics cards .....	6-2
6.1.4	Installing three CrossFireX™ graphics cards.....	6-3
6.1.5	Installing four CrossFireX™ graphics cards.....	6-4
6.1.6	Installing the device drivers.....	6-5
6.1.7	Enabling the AMD® CrossFireX™ technology.....	6-5

## Contents

<b>6.2</b>	<b>NVIDIA® SLI® technology.....</b>	<b>6-7</b>
6.2.1	Requirements.....	6-7
6.2.2	Installing two SLI-ready graphics cards.....	6-7
6.2.3	Installing three SLI-ready graphics cards.....	6-8
6.2.4	Installing four SLI-ready graphics cards.....	6-9
6.2.5	Installing the device drivers.....	6-10
6.2.6	Enabling the NVIDIA® SLI® technology.....	6-10

### Appendices

<b>Z170-WS block diagram.....</b>	<b>A-1</b>
<b>Notices .....</b>	<b>A-2</b>
<b>ASUS contact information.....</b>	<b>A-6</b>

# Safety information

## Electrical safety

- To prevent electrical shock hazard, disconnect the power cable from the electrical outlet before relocating the system.
- When adding or removing devices to or from the system, ensure that the power cables for the devices are unplugged before the signal cables are connected. If possible, disconnect all power cables from the existing system before you add a device.
- Before connecting or removing signal cables from the motherboard, ensure that all power cables are unplugged.
- Seek professional assistance before using an adapter or extension cord. These devices could interrupt the grounding circuit.
- Ensure that your power supply is set to the correct voltage in your area. If you are not sure about the voltage of the electrical outlet you are using, contact your local power company.
- If the power supply is broken, do not try to fix it by yourself. Contact a qualified service technician or your retailer.

## Operation safety

- Before installing the motherboard and adding devices on it, carefully read all the manuals that came with the package.
- Before using the product, ensure all cables are correctly connected and the power cables are not damaged. If you detect any damage, contact your dealer immediately.
- To avoid short circuits, keep paper clips, screws, and staples away from connectors, slots, sockets and circuitry.
- Avoid dust, humidity, and temperature extremes. Do not place the product in any area where it may become wet.
- Place the product on a stable surface.
- If you encounter technical problems with the product, contact a qualified service technician or your retailer.

## About this guide

This user guide contains the information you need when installing and configuring the motherboard.

## How this guide is organized

This guide contains the following parts:

### 1. Chapter 1: Product Introduction

This chapter describes the features of the motherboard and the new technology it supports. It includes description of the switches, jumpers, and connectors on the motherboard.

### 2. Chapter 2: Basic Installation

This chapter lists the hardware setup procedures that you have to perform when installing system components.

### 3. Chapter 3: BIOS Setup

This chapter tells how to change system settings through the BIOS Setup menus. Detailed descriptions of the BIOS parameters are also provided.

### 4. Chapter 4: Software Support

This chapter describes the contents of the support DVD that comes with the motherboard package and the software.

### 5. Chapter 5: RAID Support

This chapter describes the RAID configurations.

### 6. Chapter 6: Multi GPU Support

This chapter describes how to install and configure multiple AMD® CrossFire™ and NVIDIA® SLI® graphics cards.

## Where to find more information

Refer to the following sources for additional information and for product and software updates.

### 1. ASUS website

The ASUS website ([www.asus.com](http://www.asus.com)) provides updated information on ASUS hardware and software products.

### 2. Optional documentation

Your product package may include optional documentation, such as warranty flyers, that may have been added by your dealer. These documents are not part of the standard package.



## Conventions used in this guide

To ensure that you perform certain tasks properly, take note of the following symbols used throughout this manual.



**DANGER/WARNING:** Information to prevent injury to yourself when trying to complete a task.



**CAUTION:** Information to prevent damage to the components when trying to complete a task.



**IMPORTANT:** Instructions that you **MUST** follow to complete a task.



**NOTE:** Tips and additional information to help you complete a task.

## Typography

**Bold text**

Indicates a menu or an item to select.

*Italics*

Used to emphasize a word or a phrase.

<Key>

Keys enclosed in the less-than and greater-than sign means that you must press the enclosed key.

Example: <Enter> means that you must press the Enter or Return key.

<Key1> + <Key2> + <Key3>

If you must press two or more keys simultaneously, the key names are linked with a plus sign (+).

## Z170-WS specifications summary

CPU	<p>LGA1151 socket for 6th Generation Intel® Core™ i7/ i5/ i3/Pentium®/ Celeron® Processors</p> <p>Supports 14nm CPU</p> <p>Supports Intel® Turbo Boost Technology 2.0*</p> <p>* The Intel® Turbo Boost Technology 2.0 support depends on the CPU types.</p>
Chipset	Intel® Z170 Express Chipset
Memory	<p>4 x DIMM, max. 64GB, DDR4 3466 (O.C.) / 3400 (O.C.) / 3333 (O.C.) / 3300 (O.C.) / 3200 (O.C.) / 3000 (O.C.) / 2800 (O.C.)* / 2666(O.C.)* / 2400(O.C.)* / 2133 MHz, non-ECC, un-buffered memory</p> <p>Dual channel memory architecture</p> <p>Supports Intel® Extreme Memory Profile (XMP)</p> <p>* Hyper DIMM support is subject to the physical characteristics of individual CPUs. Please refer to Memory QVL (Qualified Vendors List) for details.</p>
Expansion slots	<p>4 x PCI Express 3.0/2.0 x16 slots (single at x16 , dual at x16/x16 mode, triple at x16/x8/x8 mode or quad x8/x8/x8/x8 mode)</p> <p>1 x PCI Express 3.0/2.0 x4 slot (max. at x4 mode, compatible with PCIe x1, x2 and x4 devices)</p>
VGA	<p>Integrated Graphics Processor- Intel® HD Graphics support</p> <p>Multi-VGA output support: DisplayPort/HDMI port</p> <p>Supports DisplayPort 1.2* with max. resolution 4096x2304@24Hz/ 4096x2304@60Hz</p> <p>Supports HDMI 2.0 with max. resolution 4096x2160@60/24Hz**</p> <p>Supports Intel® InTru™ 3D/Quick Sync Video/Clear Video HD Technology/Insider™</p> <p>Supports up to 2 displays simultaneously</p> <p>Maximum shared memory of 512MB</p> <p>* DP 1.2 Multi-Stream Transport compliant, supports DP 1.2 monitor daisy chain up to 3 displays</p> <p>** HDMI 2.0 60Hz resolution support requires necessary drivers update</p>
Multi-GPU support	<p>Supports NVIDIA® 4-Way/Quad-GPU SLI® Technology (with 4 PCIe16 graphics card)</p> <p>Supports AMD® 4-Way/Quad-GPU CrossFireX™ Technology(with 4 PCIe16 graphics card)</p>

(continued on the next page)

## Z170-WS specifications summary

<p><b>Storage</b></p>	<p><b>Intel® Z170 Express Chipset with RAID 0, 1, 5, 10 and Intel Rapid Storage Technology 14 support*</b></p> <ul style="list-style-type: none"> <li>- 2 x M.2 Socket 3 with M Key, type 2242/2260/2280/22110 storage devices support (both SATA &amp; PCIE mode)**</li> <li>- 6 x SATA 6.0 Gb/s ports (gray)</li> <li>- Supports Intel® Smart Response Technology***</li> <li>- 1 x U.2 connector (support U.2 NVMe device)</li> </ul> <p>* Supports PCIE RAID configurations via onboard M.2_1 and M.2_2 storages.</p> <p>** The M.2_1 socket shares SATA ports with SATA6G_56; the M.2_2 socket shares bandwidth with U.2 connector, and shares SATA ports with SATA6G_12 when using SATA mode</p> <p>***These functions will work depending on the CPU installed.</p>
<p><b>LAN</b></p>	<p>Gigabit Intel LAN connection- 802.3az Energy Efficient Ethernet (EEE) appliance</p> <p>Intel® I219-LM Gigabit LAN- Dual interconnect between the integrated Media Access Controller (MAC) and physical layer (PHY)</p> <p>Intel® I210-AT Gigabit LAN controller</p> <p>ASUS Turbo LAN Utility</p>
<p><b>Audio</b></p>	<p><b>Realtek® ALC1150 8-channel high definition audio CODEC featuring Crystal Sound 3</b></p> <ul style="list-style-type: none"> <li>- Separate layer for left and right track, ensuring both sound deliver equal quality</li> <li>- Top notch audio sensation delivers according to the audio configuration</li> <li>- Audio shielding ensures precise analog/digital separation and greatly reduced multi-lateral interference</li> <li>- Audio Amplifier to enhance the highest quality sound for headphone and speakers</li> <li>- Premium Japan-made audio capacitors provides warm, natural, and immersive sound with exceptional clarity and fidelity</li> <li>- High quality 112dB SNR stereo playback output (Line-out@back) &amp; 104dB SNR recording input (Line-in) support</li> <li>- Absolute Pitch 192khz/24bit true BD lossless sound</li> <li>- BD audio layer content protection</li> <li>- DTS Studio Sound</li> <li>- DTS Connect</li> <li>- Supports jack-detection, multi-streaming, front panel jack-retasking (MIC)</li> <li>- Optical S/PDIF out port at back I/O</li> </ul>

*(continued on the next page)*

## Z170-WS specifications summary

<b>USB</b>	<b>Intel® Z170 Express Chipset</b> <ul style="list-style-type: none"><li>- 5 x USB 3.0/2.0 ports (4 ports @mid-board, 1 vertical Type A Connector,blue)</li><li>- 6 x USB 2.0/1.1 ports (2 ports @mid-board, 4 port @back panel, black)</li></ul> <b>ASMedia® USB 3.0 Hubs</b> <ul style="list-style-type: none"><li>- 4 x USB 3.0/2.0 ports (4 ports @back panel,blue)</li></ul> <b>ASMedia® USB 3.1 controllers</b> <ul style="list-style-type: none"><li>- 1 x USB 3.1/3.0/2.0 ports @back panel (teal blue, Type A)</li><li>- 1 x USB 3.1/3.0/2.0 port @back panel (Type C)</li></ul>
<b>ASUS Exclusive Features</b>	<b>Superb Performance</b> <b>OC Design: ASUS PRO Clock Technology</b> <ul style="list-style-type: none"><li>- Full BCLK range for extreme overclocking performance.</li></ul> <b>5-Way Optimization</b> <ul style="list-style-type: none"><li>- Whole system optimization with a single click! Perfectly consolidates better CPU performance, power saving, digital power control, system cooling and app usages.</li></ul> <b>DIGI+ Power Control</b> <ul style="list-style-type: none"><li>-CPU Power: Digital 8-phase power design</li><li>-iGPU Power: Digital 4-phase power design</li><li>-DRAM Power: Digital 2-phase power design</li></ul> <b>TPU</b> <ul style="list-style-type: none"><li>- Auto Tuning, GPU Boost, 2-level TPU switch</li></ul> <b>EPU</b> <ul style="list-style-type: none"><li>- EPU, EPU switch</li></ul> <b>Fan Xpert 3</b> featuring Fan Auto Tuning function and multiple thermistors selection for optimized system cooling control <b>Turbo App</b> featuring system performance tuning, network priority, and audio scene configuration for selected applications. <b>UEFI BIOS</b> <ul style="list-style-type: none"><li>- Most advanced options with fast response time</li></ul> <b>Special Memory O.C. Design</b> <ul style="list-style-type: none"><li>- Superb memory O.C. capability under full load by minimizing the coupling noise and signal reflection effect</li></ul> <b>PC Cleaner</b> <ul style="list-style-type: none"><li>- Fast and easy way to get rid of unnecessary junk files</li></ul>

*(continued on the next page)*

# Z170-WS specifications summary

<p><b>ASUS Exclusive Features</b></p>	<p><b>Media Streamer</b></p> <ul style="list-style-type: none"> <li>- Pipe music or movies from your PC to a smart TV, your entertainment goes wherever you go!</li> <li>- Media Streamer app for portable smartphone/tablet, supporting iOS 7 &amp; Android 4.0 systems</li> </ul> <p><b>eSports Champions</b></p> <p><b>Turbo LAN</b></p> <ul style="list-style-type: none"> <li>- Fast and smooth online gaming with lower pings and less lags</li> </ul> <p><b>Crystal Sound 3</b></p> <ul style="list-style-type: none"> <li>- Hear the cleanest sound with dedicated audio design onboard!</li> </ul> <p><b>Turbo APP</b></p> <ul style="list-style-type: none"> <li>- Tailored app performance, network priority and audio configuration for your needs</li> </ul> <p><b>EZ DIY</b></p> <p><b>Push Notice</b></p> <ul style="list-style-type: none"> <li>- Monitor your PC status with smart devices in real time</li> </ul> <p><b>USB BIOS Flashback</b> with USB BIOS Flashback Wizard for EZ BIOS download scheduling</p> <p><b>UEFI BIOS EZ Mode</b> featuring friendly graphics user interface</p> <ul style="list-style-type: none"> <li>- CrashFree BIOS 3</li> <li>- EZ Flash 3</li> </ul> <p><b>Q-Design</b></p> <ul style="list-style-type: none"> <li>- ASUS Q-code</li> <li>- ASUS Q-Shield</li> <li>- ASUS Q-LED (CPU, DRAM, VGA, HDD LED)</li> <li>- ASUS Q-Slot</li> <li>- ASUS Q-DIMM</li> <li>- ASUS Q-Connector</li> </ul>
<p><b>ASUS Special Features</b></p>	<ul style="list-style-type: none"> <li>- USB 3.1 Boost</li> <li>- Key Express</li> <li>- MemOK!</li> <li>- EZ XMP</li> </ul>
<p><b>ASUS Quiet Thermal Solution</b></p>	<p><b>Quiet Thermal Design:</b></p> <ul style="list-style-type: none"> <li>- ASUS Fan Xpert 3</li> <li>- ASUS Fanless Design: Heat-pipe solution</li> </ul>
<p><b>BIOS features</b></p>	<p>128 Mb Flash ROM, UEFI AMI BIOS, PnP, DMI3.0, WfM2.0, SM BIOS 3.0, ACPI 5.0, Multi-language BIOS, ASUS EZ Flash 3, CrashFree BIOS 3, F11 EZ Tuning Wizard, F6 Qfan Control, F3 My Favorites, Quick Note, Last Modified log, F12 PrintScreen and ASUS DRAM SPD (Serial Presence Detect) memory information</p>

*(continued on the next page)*

## Z170-WS specifications summary

<b>Rear Panel I/O Ports</b>	<ul style="list-style-type: none"><li>1 x USB BIOS Flashback button</li><li>1 x Q-Code Logger button</li><li>1 x DisplayPort</li><li>1 x HDMI port</li><li>1 x Optical S/PDIF out</li><li>2 x Intel LAN (RJ45) ports</li><li>1 x USB 3.1/3.0/2.0 ports (teal blue, Type A)</li><li>1 x USB 3.1/3.0/2.0 ports (Type C)</li><li>4 x USB 3.0/2.0 port (blue)</li><li>4 x USB 2.0/1.1 port (black)</li><li>8-channel Audio I/O ports</li></ul>
<b>Internal I/O connectors</b>	<ul style="list-style-type: none"><li>2 x USB 3.0/2.0 connectors support additional 4 USB ports (19-pin)</li><li>1 x USB 2.0/1/1 connectors support additional 2 USB ports</li><li>1 x vertical type A USB 3.0 connector</li><li>2 x M.2 Socket 3 (for M Key, type 2242/2260/2280/22110 devices)</li><li>1 x U.2 connector (support U.2 NVMe device)</li><li>6 x SATA 6.0Gb/s connectors (6 x gray)</li><li>1 x CPU Fan connector (4-pin) for both 3-pin(DC mode) and 4-pin(PWM mode) CPU coolers control with auto detection support</li><li>1 x CPU OPT Fan connector (4-pin)</li><li>1 x Water Pump header</li><li>4 x Chassis Fan connectors (4-pin) for both 3-pin(DC mode) and 4-pin(PWM mode) coolers control</li><li>1 x Front panel audio connector (AAFP)</li><li>1 x S/PDIF out header</li><li>1 x Thunderbolt header (5-pin) for ASUS ThunderboltEX series support</li><li>1 x TPM connector</li><li>1 x 24-pin EATX Power connector</li><li>2 x 8-pin EATX 12V Power connector</li><li>1 x 6-pin EATX 12V_1 Power Connector</li><li>1 x System Panel(Q-Connector)</li><li>1 x MemOK! button</li><li>1 x Clear CMOS jumper</li><li>1 x DRCT(Direct Key) connector</li><li>1 x TPU switch (advanced two-stage adjustments)</li><li>1 x EPU switch</li><li>1 x EZ XMP switch</li><li>1 x Power-on button</li><li>1 x 5-pin EXT_FAN(Extension Fan) connector</li></ul>

*(continued on the next page)*

## Z170-WS specifications summary

<b>Manageability</b>	WfM 2.0, DMI 3.0, WOL by PME, PXE
<b>Support DVD contents</b>	Drivers ASUS Utilities EZ Update Anti-virus software (OEM version)
<b>Operating system support</b>	Windows® 10* Windows® 8.1* Windows® 7  <b>*64-bit supported only</b>
<b>Form factor</b>	ATX Form Factor, 12" x 9.6" (30.5 cm x 24.4 cm)







---

Specifications are subject to change without notice.

---

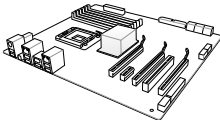
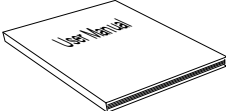
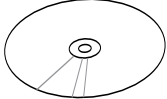
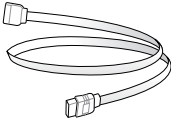
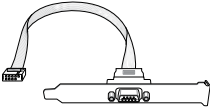
# Package contents

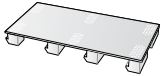
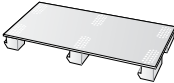
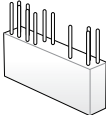
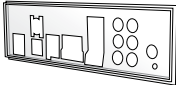
Check your motherboard package for the following items:

		
<p><b>ASUS Z170-WS motherboard</b></p>	<p><b>User manual</b></p>	<p><b>Support DVD</b></p>
		
<p><b>6 x Serial ATA 6.0 Gb/s cables</b></p>	<p><b>COM port bracket</b></p>	<p><b>1 x ASUS SLI bridge connector</b></p>
		
<p><b>1 x ASUS 4-Way SLI bridge connector</b></p>	<p><b>1 x ASUS 3-Way SLI bridge connector</b></p>	<p><b>1 x 2-in-1 Q-connector</b></p>
		
<p><b>1 x Q-Shield</b></p>	<p><b>2 x M.2 Screw package</b></p>	<p><b>1 x CPU Installation Tool</b></p>



# Installation tools and components

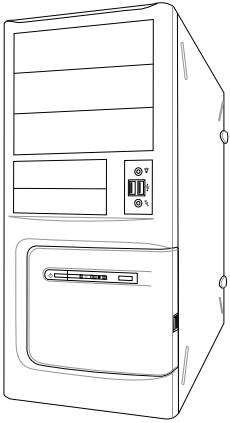

**PC chassis**

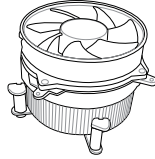

**Intel® LGA1151 compatible CPU Fan**

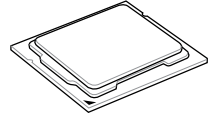

**Intel® LGA1151 CPU**

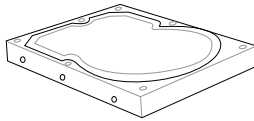

**SATA hard disk drive**



**Phillips (cross) screwdriver**

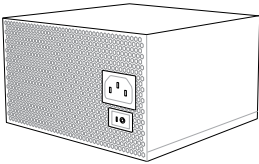

**Power supply unit**

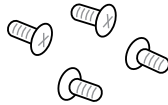

**1 bag of screws**

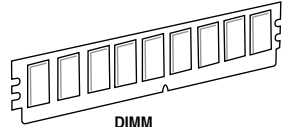

**DIMM**

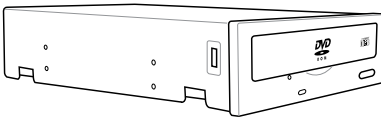

**SATA optical disc drive (optional)**

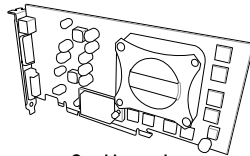

**Graphics card**



---

The tools and components in the table above are not included in the motherboard package.

---



# Product Introduction

# 1

## 1.1 Special features

### 1.1.1 Product highlights

#### **LGA1151 socket for the 6th Generation Intel® Core™ i7/Intel® Core™ i5/Intel® Core™ i3, Pentium® and Celeron® processors**

This motherboard supports 6th generation Intel® Core™ i7/Intel® Core™ i5/Intel® Core™ i3, Pentium®, and Celeron® processors in the LGA1151 package. It provides great graphics and system performance with its GPU, dual-channel DDR4 memory slots and PCI Express 2.0/3.0 expansion slots.

#### **Intel® Z170 Express Chipset**

Intel® Z170 Express Chipset is a single chipset that supports the LGA1151 socket for the 6th generation Intel® Core™ i7/Intel® Core™ i5/Intel® Core™ i3, Pentium®, and Celeron® processors. It utilizes the serial point-to-point links, which increases bandwidth and enhances the system's performance. It natively supports up to ten USB 3.0 ports, six SATA 6 Gb/s ports, and M.2 Gen 3 X4 support for faster data retrieval.

#### **PCI Express® 3.0**

PCI Express® 3.0 (PCIe 3.0) is the PCI Express bus standard that provides twice the performance and speed of PCIe 2.0. It provides an optimal graphics performance, unprecedented data speed and seamless transition with its complete backward compatibility to PCIe 1.0/2.0 devices.

#### **Dual-Channel DDR4 3466 MHz Support**

The motherboard supports the dual-channel DDR4 memory that features data transfer rates of DDR4 3466 MHz to boost the system's performance, and to meet the higher bandwidth requirements of 3D graphics, multimedia and Internet applications.

#### **PCIe 3.0 x4 M.2 Support**

With a 4x PCI Express 3.0/2.0 bandwidth, the M.2 can support up to 32 Gbit/s of data transfer speed. It is a perfect choice for the operating system or application drive, making your system and its installed apps work in a faster pace.

#### **Complete USB 3.1 integration**

This motherboard has the latest USB 3.1 connectivity built in for the very fastest USB data transfers — that's up to 10 Gb/s, or twice as fast as USB 3.0. The next-generation standard is completely backward-compatible with your existing USB devices, and you'll be all set for USB 3.1's breakneck speeds.

## 1.1.2 ASUS-exclusive workstation features

### PCI Express 3.0 for 4-Way CrossFireX™ and SLI® Support

The motherboard provides PCI Express x16 slots for 4-Way AMD CrossFireX™ and NVIDIA® SLI® graphics cards, giving you with ample graphics power to easily run even the most demanding computer games for enhanced entertainment.

### Q-Code Logger

Q-Code Logger is your one-touch troubleshooter that lets you easily check Q-Code event logs without opening the computer's case. If a workstation is behaving abnormally, plug a flash drive into the adjacent USB port, press the motherboard's dedicated Flash Log button and all ASUS Q-Code event logs for the current live session will be copied to the drive.

### ProCool Connector

ProCool eliminates the hollow areas associated with traditional power connectors, ensuring an exceptionally close and secure connection with this motherboard. This design is much stronger, and provides better heat dissipation, allowing cooler operating temperatures.

### Built-in dual Intel® Ethernet

For more reliable networking, this motherboard features the latest server class built-in dual Intel® Ethernet. This leads to lower CPU utilization and temperatures, achieving outstanding performance, and providing better support for diverse operating systems.

## 1.1.3 Other special features

### DTS Connect

To get the most out of your audio entertainment across all formats and quality levels, DTS Connect combines two enabling technologies, DTS Neo:PC™ upmixes stereo sources (CDs, MP3s, WMAs, internet radio) into as many as 7.1 channels of incredible surround sound. Consumers can connect their PC to a home theater system. DTS Interactive is capable of performing multi-channel encoding of DTS bitstreams on personal computers, and sending encoded bitstreams out of a digital audio connection (such as S/PDIF or HDMI) designed to deliver audio to an external decoder.

### ErP Ready

The motherboard is European Union's Energy-related Products (ErP) ready, and ErP requires products to meet certain energy efficiency requirement in regards to energy consumptions. This is in line with ASUS vision of creating environment-friendly and energy-efficient products through product design and innovation to reduce carbon footprint of the product and thus mitigate environmental impacts.

## 1.2 Motherboard overview

### 1.2.1 Before you proceed

Take note of the following precautions before you install motherboard components or change any motherboard settings.



- 
- Unplug the power cord from the wall socket before touching any component.
  - Before handling components, use a grounded wrist strap or touch a safely grounded object or a metal object, such as the power supply case, to avoid damaging them due to static electricity.
  - Hold components by the edges to avoid touching the ICs on them.
  - Whenever you uninstall any component, place it on a grounded antistatic pad or in the bag that came with the component.
  - Before you install or remove any component, ensure that the ATX power supply is switched off or the power cord is detached from the power supply. Failure to do so may cause severe damage to the motherboard, peripherals, or components.
-

## 1.2.2 Motherboard layout

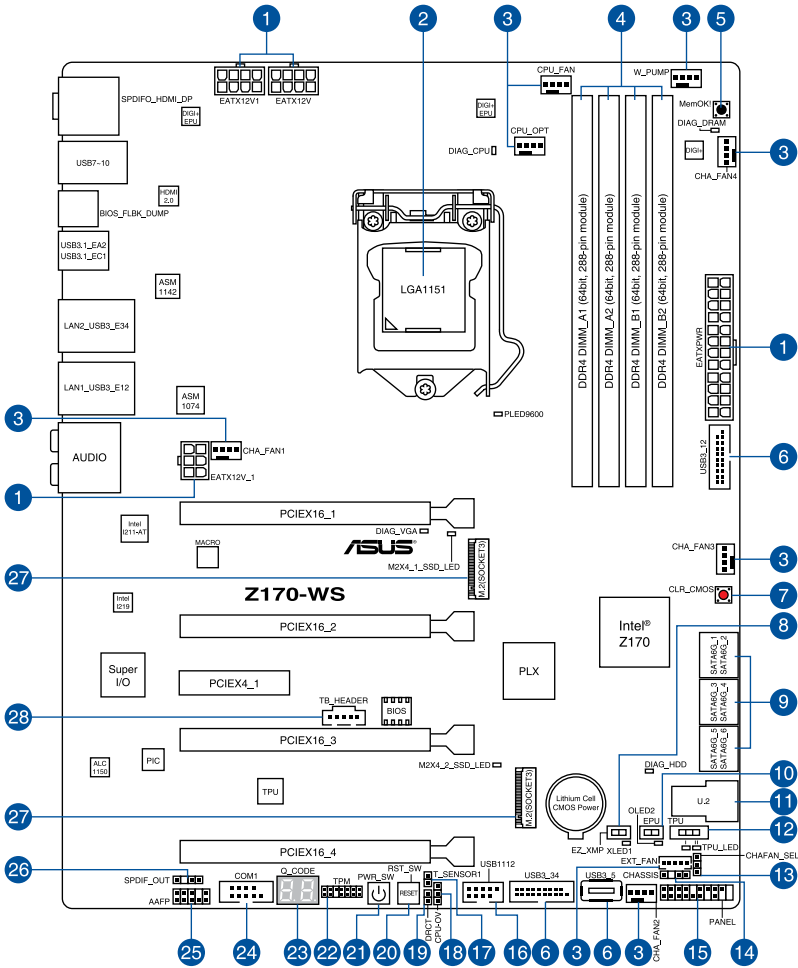

Refer to 1.2.9 Internal connectors and 2.3.1 Rear I/O connection for more information about rear panel connectors and internal connectors.

## Layout contents

Connectors/Jumpers/Buttons and switches/Slots	Page
1. ATX power connectors (24-pin EATXPWR, 2 x 8-pin EATX12V)	1-32
2. LGA1151 CPU socket	1-6
3. CPU, water pump, CPU optional, extension, and chassis fan connectors (4-pin CPU_FAN; 4-pin W_PUMP; 4-pin CPU_OPT; 5-pin EXT_FAN; 4-pin CHA_FAN1-4)	1-31
4. DDR4 DIMM slots	1-7
5. MemOK! button	1-13
6. USB 3.0 connectors (20-1 pin USB3_12; USB3_34; USB3_5)	1-29
7. Clear CMOS button (CLR_CMOS)	1-16
8. EZ XMP switch	1-16
9. Intel® Z170 Serial ATA 6 Gb/s connectors (7-pin SATA6G_1-6)	1-25
10. EPU switch	1-15
11. U.2 connector (U.2)	1-26
12. TPU switch	1-14
13. Chassis Fan control setting (3 pin CHAFAN_SEL)	1-17
14. Chassis Intrusion connector (4-1 pin CHASSIS)	1-28
15. System panel connector (20-5 pin PANEL)	1-33
16. USB 2.0 connectors (10-1 USB1112)	1-30
17. T Sensor connector (2-pin T_SENSOR1)	1-27
18. CPU Over Voltage jumper (3-pin CPU_OV)	1-17
19. DirectKey connector (2-pin DRCT)	1-34
20. Reset button	1-12
21. Power button	1-12
22. TPM connector (14-1 pin TPM)	1-28
23. Q-Code LEDs	1-20
24. Serial port connector (10-1 pin COM1)	1-36
25. Front panel audio connector (10-1 pin AAFP)	1-26
26. Digital audio connector (4-1 pin SPDIF_OUT)	1-26
27. M.2 Socket 3	1-35
28. Thunderbolt header (5-pin TB_HEADER)	1-34

## 1.2.3 Central Processing Unit (CPU)

The motherboard comes with a surface mount LGA1151 socket designed for the 6th Generation Intel® Core™ i7 / Intel® Core™ i5 / Intel® Core™ i3, Pentium®, and Celeron® processors.

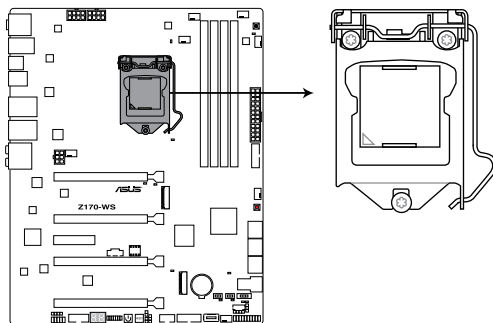

**Z170-WS CPU LGA1151**



---

Ensure that you install the correct CPU designed for LGA1151 socket only. DO NOT install a CPU designed for other sockets on the LGA1151 socket.

---



- Ensure that all power cables are unplugged before installing the CPU.
  - Upon purchase of the motherboard, ensure that the PnP cap is on the socket and the socket contacts are not bent. Contact your retailer immediately if the PnP cap is missing, or if you see any damage to the PnP cap/socket contacts/motherboard components. ASUS will shoulder the cost of repair only if the damage is shipment/transit-related.
  - Keep the cap after installing the motherboard. ASUS will process Return Merchandise Authorization (RMA) requests only if the motherboard comes with the cap on the LGA1151 socket.
  - The product warranty does not cover damage to the socket contacts resulting from incorrect CPU installation/removal, or misplacement/loss/incorrect removal of the PnP cap.
-



## 1.2.4 System memory

The motherboard comes with four DDR 4 (Double Data Rate 4) Dual Inline Memory Modules (DIMM) slots.



A DDR4 module is notched differently from a DDR, DDR2 or DDR3 module. DO NOT install a DDR, DDR2 or DDR3 memory module to the DDR4 slot.

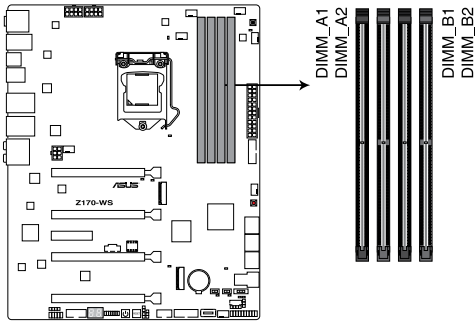

Z170-WS 288-pin DDR4 DIMM socket

### Recommended memory configurations

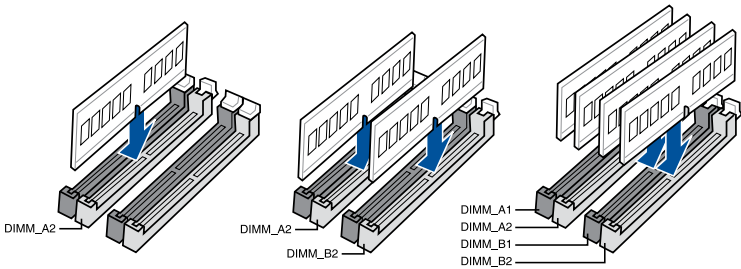

## Memory configurations

You may install 2 GB, 4 GB, 8 GB and 16 GB unbuffered and non-ECC DDR4 DIMMs into the DIMM sockets.



- You may install varying memory sizes in Channel A and Channel B. The system maps the total size of the lower-sized channel for the dual-channel configuration. Any excess memory from the higher-sized channel is then mapped for single-channel operation.
- According to Intel® CPU spec, DIMM voltage below 1.65 V is recommended to protect the CPU.
- Due to the memory address limitation on 32-bit Windows® OS, when you install 4GB or more memory on the motherboard, the actual usable memory for the OS can be about 3GB or less. For effective use of memory, we recommend that you do any of the following:
  - a) Use a maximum of 3GB system memory if you are using a 32-bit Windows® OS.
  - b) Install a 64-bit Windows® OS when you want to install 4 GB or more on the motherboard.
  - c) For more details, refer to the Microsoft® support site at <http://support.microsoft.com/kb/929605/en-us>.
- This motherboard does not support DIMMs made up of 512 Mb (64 MB) chips or less (Memory chip capacity counts in Megabit, 8 Megabit/Mb = 1 Megabyte/MB).



- The default memory operation frequency is dependent on its Serial Presence Detect (SPD), which is the standard way of accessing information from a memory module. Under the default state, some memory modules for overclocking may operate at a lower frequency than the vendor-marked value. To operate at the vendor-marked or at a higher frequency, refer to section **3.5 Ai Tweaker menu** for manual memory frequency adjustment.
- For system stability, use a more efficient memory cooling system to support a full memory load (4 DIMMs) or overclocking condition.
- Memory modules with memory frequency higher than 2133MHz and their corresponding timing or the loaded XMP profile is not the JEDEC memory standard. The stability and compatibility of the memory modules depend on the CPU's capabilities and other installed devices.
- Always install the DIMMs with the same CAS Latency. For an optimum compatibility, we recommend that you install memory modules of the same version or data code (D/C) from the same vendor. Check with the vendor to get the correct memory modules.
- Visit the ASUS website for the latest QVL.

## 1.2.5 Expansion slots



Unplug the power cord before adding or removing expansion cards. Failure to do so may cause you physical injury and damage motherboard components.

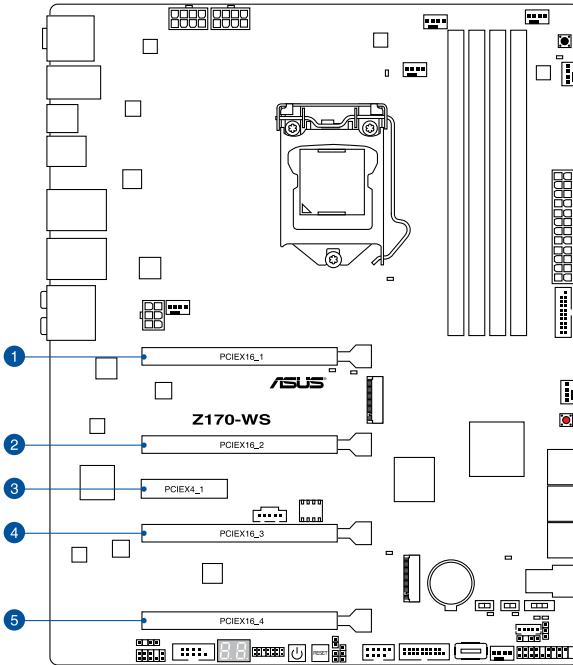

Slot No.	Slot Description
1	PCIe 3.0/2.0 x16_1 slot
2	PCIe 3.0/2.0 x16_2 slot
3	PCIe 2.0 x4_1 slot
4	PCIe 3.0/2.0x16_3 slot
5	PCIe 3.0/2.0 x16_4 slot

Slot No.	PCI Express 3.0 operating mode			
	Single VGA	SLI CrossFireX	3-WAY SLI CrossFireX	4-WAY SLI CrossFireX
1	x16 (single VGA recommended)	x16	x8	x8
2	-	-	x8	x8
4	-	x16 (dual VGA recommended)	x16	x8
5	-	-	-	x8



- 
- We recommend that you provide sufficient power when running CrossFireX™ or SLI® mode.
  - Connect a chassis fan to the motherboard connector labeled CHA\_FAN1-4 when using multiple graphics cards for better thermal environment.
  - We recommend you connect an EATX 12V1 cable when running CrossFireX™ and SLI®.
-

## IRQ assignments for this motherboard

	A	B	C	D	E	F	G	H
PCIe x16_1	shared	-	-	-	-	-	-	-
PCIe x16_2	shared	-	-	-	-	-	-	-
PCIe x16_3	shared	-	-	-	-	-	-	-
PCIe x16_4	shared	-	-	-	-	-	-	-
PCIe x4_1	shared	-	-	-	-	-	-	-
SMBUS Controller	shared	-	-	-	-	-	-	-
Intel SATA Controller	-	-	-	-	-	-	-	shared
Intel LAN1(i219)	shared	-	-	-	-	-	-	-
Intel LAN2(I210)	-	-	shared	-	-	-	-	-
Intel xHCI	shared	-	-	-	-	-	-	-
HD Audio	shared	-	-	-	-	-	-	-
ASMedia 1142_1	shared	-	-	-	-	-	-	-

## 1.2.6 Onboard buttons and switches

Onboard buttons and switches allow you to fine-tune performance when working on a bare or open-case system. This is ideal for overclockers and gamers who continually change settings to enhance system performance.

### 1. Power-on button

The motherboard comes with a power-on button that allows you to power up or wake up the system. The button also lights up when the system is plugged to a power source indicating that you should shut down the system and unplug the power cable before removing or installing any motherboard component.

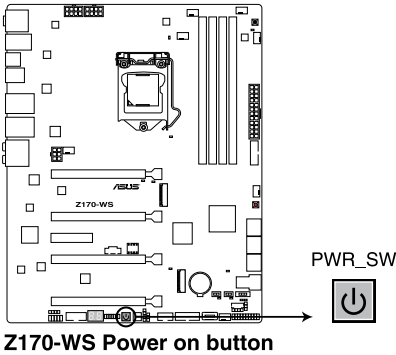

### 2. Reset button

Press the reset button to reboot the system.

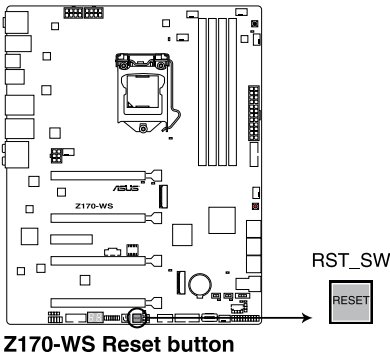

### 3. MemOK! button

Installing DIMMs that are not compatible with the motherboard may cause system boot failure, and the DRAM\_LED near the MemOK! button lights continuously. Press and hold the MemOK! button until the DRAM\_LED starts blinking to begin automatic memory compatibility tuning for successful boot.

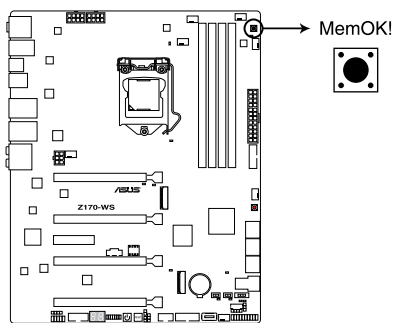

**Z170-WS MemOK! button**



- Refer to section **1.2.8 Onboard LEDs** for the exact location of the DRAM\_LED.
- The DRAM\_LED also lights up when the DIMM is not properly installed. Turn off the system and reinstall the DIMM before using the MemOK! function.
- The MemOK! button does not function under Windows® OS environment.
- During the tuning process, the system loads and tests failsafe memory settings. It takes about 30 seconds for the system to test one set of failsafe settings. If the test fails, the system reboots and test the next set of failsafe settings. The blinking speed of the DRAM\_LED increases, indicating different test processes.
- Due to memory tuning requirement, the system automatically reboots when each timing set is tested. If the installed DIMMs still fail to boot after the whole tuning process, the DRAM\_LED lights continuously. Replace the DIMMs with ones recommended in the Memory QVL (Qualified Vendors Lists) in this user manual or at [www.asus.com](http://www.asus.com).
- If you turn off the computer and replace DIMMs during the tuning process, the system continues memory tuning after turning on the computer. To stop memory tuning, turn off the computer and unplug the power cord for about 5–10 seconds.
- If your system fails to boot up due to BIOS overlocking, press the MemOK! button to boot and load the BIOS default settings. A message will appear during POST reminding you that the BIOS has been restored to its default settings.
- We recommend that you download and update to the latest BIOS version from [www.asus.com](http://www.asus.com) after using the MemOK! function.

#### 4. TPU switch

With its two-level adjustment functions, the TPU allows you to automatically adjust the CPU ratio and clock speed for an optimal system performance.



- Enable this switch when the system is powered off.
- When the TPU switch is set to Enabled (TPU\_I: CPU Ratio Boost), the system automatically adjusts the CPU ratio for an enhanced performance.
- When the TPU switch is set to Enabled (TPU\_II: CPU BCLK and Ratio Boost), the system automatically adjusts the base clock rate (BCLK) and the CPU ratio for a more enhanced performance.

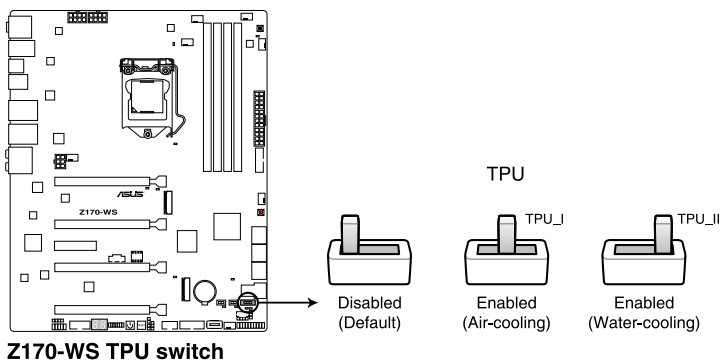

- The TPU LED (TPU\_LED) near the TPU switch lights up when the TPU switch is enabled. Refer to section 1.2.8 Onboard LEDs for the exact location of the TPU LED.
- If you enable this switch under Windows® OS environment, the TPU function will be activated after the next system bootup.
- You may use the 5-Way Optimization and TPU feature in the AI Suite 3 application, adjust the BIOS setup program or enable the TPU switch at the same time. However, the system will use the last setting you have made.



## 5. EPU switch

Enable this switch to automatically detect the current PC loadings and intelligently moderate the power consumption.



Enable this switch when the system is powered off.

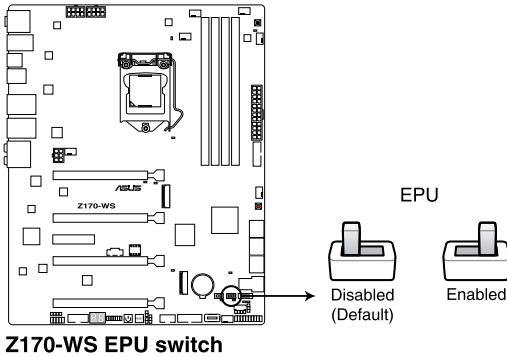

- The EPU LED (OLED2) near the EPU switch lights up when the EPU switch is enabled. Refer to section **1.2.8 Onboard LEDs** for the exact location of the EPU LED.
- If you enable this switch under Windows® OS environment, the EPU function will be activated after the next system bootup.
- You may change the EPU settings in the software application or BIOS setup program and enable the EPU function at the same time. However, the system will use the last setting you have made.

## 6. Clear CMOS button (CLR\_CMOS)

Press this button to clear the BIOS setup information only when the systems hangs due to overclocking.

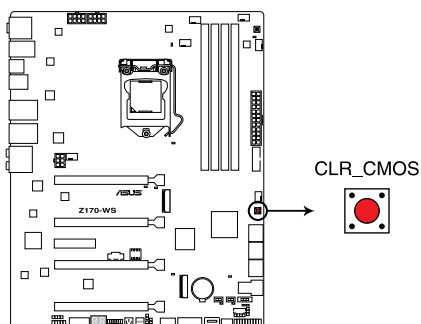

**Z170-WS CLR\_CMOS button**

## 7. EZ XMP switch

Enable this switch to overclock the installed DIMMs, allowing you to enhance the DIMM's speed and performance.

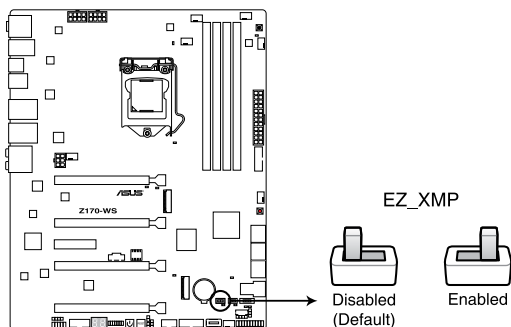

**Z170-WS EZ\_XMP switch**

## 1.2.7 Jumpers

### 1. CPU Over Voltage jumper (3-pin CPU\_OV)

The CPU Over Voltage jumper allows you to set a higher CPU voltage for a flexible overclocking system, depending on the type of the installed CPU. To gain more CPU voltage setting, insert the jumper to pins 2-3. To go back to its default CPU voltage setting, insert the jumper to pins 1-2.

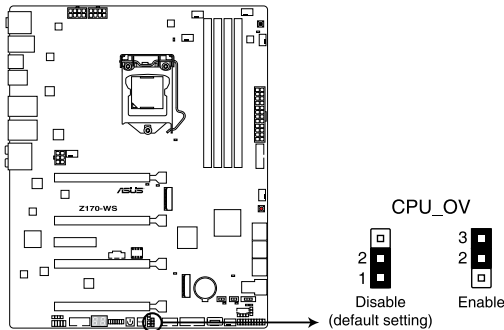

**Z170-WS CPU\_OV setting**

### 2. Chassis Fan control setting (3-pin CHAFAN\_SEL)

This jumpers allow you to switch fan pin selection. The CHAFAN\_SEL jumper is for the front fans and rear fans control. Set pins 1-2 when using 3-pin fans or pins 2-3 when using 4-pin fans.

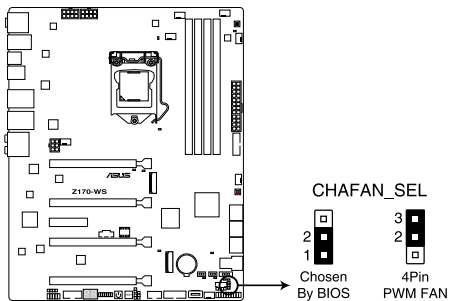

**Z170-WS CHAFAN setting**

## 1.2.8 Onboard LEDs

### 1. POST State LEDs

The POST State LEDs provide the status of these key components during POST (Power-On-Self Test): CPU, memory modules, VGA card, and hard disk drives. If an error is found, the critical component's LED stays lit up until the problem is solved.

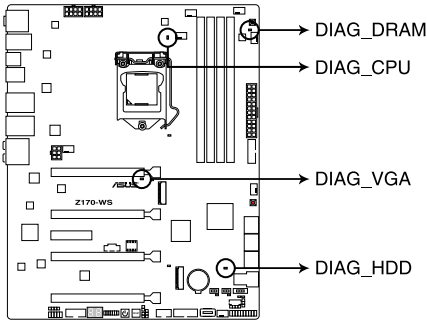

**Z170-WS Diagnosis LED**

### 2. TPU LED (TPU\_LED)

The TPU LED lights up when the TPU switch is enabled.

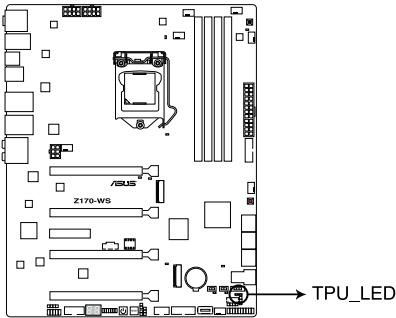

**Z170-WS TPU LED**

### 3. EPU LED (OLED2)

The EPU LED lights up when the EPU switch is enabled.

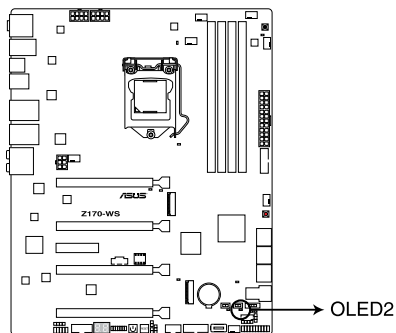

**Z170-WS EPU LED**

### 4. EZ XMP LED (XLED1)

This LED lights up when you enable the EZ XMP switch.

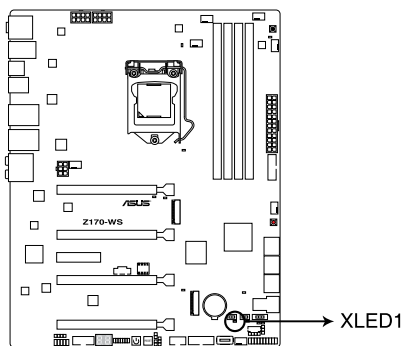

**Z170-WS XLED1**

## 5. Q-Code LEDs

The Q-Code LED design provides you with a 2-digit error code that displays the system status. Refer to the Q-Code table on the next page for details.

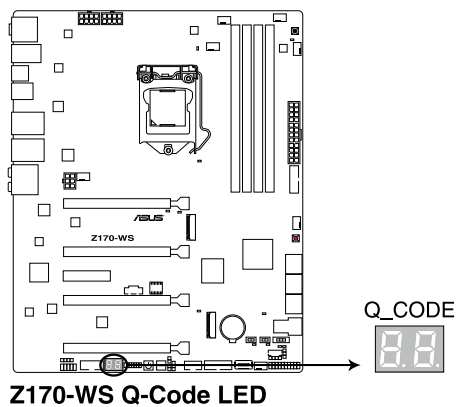

## Q-Code table

Code	Description
00	Not used
01	Power on. Reset type detection (soft/hard).
02	AP initialization before microcode loading
03	System Agent initialization before microcode loading
04	PCH initialization before microcode loading
06	Microcode loading
07	AP initialization after microcode loading
08	System Agent initialization after microcode loading
09	PCH initialization after microcode loading
0B	Cache initialization
0C – 0D	Reserved for future AMI SEC error codes
0E	Microcode not found
0F	Microcode not loaded
10	PEI Core is started
11 – 14	Pre-memory CPU initialization is started
15 – 18	Pre-memory System Agent initialization is started
19 – 1C	Pre-memory PCH initialization is started
2B – 2F	Memory initialization
30	Reserved for ASL (see ASL Status Codes section below)
31	Memory Installed
32 – 36	CPU post-memory initialization
37 – 3A	Post-Memory System Agent initialization is started
3B – 3E	Post-Memory PCH initialization is started
4F	DXE IPL is started
50 – 53	Memory initialization error. Invalid memory type or incompatible memory speed
54	Unspecified memory initialization error
55	Memory not installed
56	Invalid CPU type or Speed
57	CPU mismatch
58	CPU self test failed or possible CPU cache error
59	CPU micro-code is not found or micro-code update is failed
5A	Internal CPU error
5B	Reset PPI is not available
5C – 5F	Reserved for future AMI error codes
E0	S3 Resume is started (S3 Resume PPI is called by the DXE IPL)
E1	S3 Boot Script execution
E2	Video repost
E3	OS S3 wake vector call
E4 – E7	Reserved for future AMI progress codes
E8	S3 Resume Failed

(continued on the next page)

Code	Description
E9	S3 Resume PPI not Found
EA	S3 Resume Boot Script Error
EB	S3 OS Wake Error
EC – EF	Reserved for future AMI error codes
F0	Recovery condition triggered by firmware (Auto recovery)
F1	Recovery condition triggered by user (Forced recovery)
F2	Recovery process started
F3	Recovery firmware image is found
F4	Recovery firmware image is loaded
F5 – F7	Reserved for future AMI progress codes
F8	Recovery PPI is not available
F9	Recovery capsule is not found
FA	Invalid recovery capsule
FB – FF	Reserved for future AMI error codes
60	DXE Core is started
61	NVRAM initialization
62	Installation of the PCH Runtime Services
63 – 67	CPU DXE initialization is started
68	PCI host bridge initialization
69	System Agent DXE initialization is started
6A	System Agent DXE SMM initialization is started
6B – 6F	System Agent DXE initialization (System Agent module specific)
70	PCH DXE initialization is started
71	PCH DXE SMM initialization is started
72	PCH devices initialization
73 – 77	PCH DXE Initialization (PCH module specific)
78	ACPI module initialization
79	CSM initialization
7A – 7F	Reserved for future AMI DXE codes
90	Boot Device Selection (BDS) phase is started
91	Driver connecting is started
92	PCI Bus initialization is started
93	PCI Bus Hot Plug Controller Initialization
94	PCI Bus Enumeration
95	PCI Bus Request Resources
96	PCI Bus Assign Resources
97	Console Output devices connect
98	Console input devices connect
99	Super IO Initialization
9A	USB initialization is started
9B	USB Reset

(continued on the next page)



Code	Description
9C	USB Detect
9D	USB Enable
9E – 9F	Reserved for future AMI codes
A0	IDE initialization is started
A1	IDE Reset
A2	IDE Detect
A3	IDE Enable
A4	SCSI initialization is started
A5	SCSI Reset
A6	SCSI Detect
A7	SCSI Enable
A8	Setup Verifying Password
A9	Start of Setup
AA	Reserved for ASL (see ASL Status Codes section below)
AB	Setup Input Wait
AC	Reserved for ASL (see ASL Status Codes section below)
AD	Ready To Boot event
AE	Legacy Boot event
AF	Exit Boot Services event
B0	Runtime Set Virtual Address MAP Begin
B1	Runtime Set Virtual Address MAP End
B2	Legacy Option ROM Initialization
B3	System Reset
B4	USB hot plug
B5	PCI bus hot plug
B6	Clean-up of NVRAM
B7	Configuration Reset (reset of NVRAM settings)
B8– BF	Reserved for future AMI codes
D0	CPU initialization error
D1	System Agent initialization error
D2	PCH initialization error
D3	Some of the Architectural Protocols are not available
D4	PCI resource allocation error. Out of Resources
D5	No Space for Legacy Option ROM
D6	No Console Output Devices are found
D7	No Console Input Devices are found
D8	Invalid password
D9	Error loading Boot Option (LoadImage returned error)
DA	Boot Option is failed (StartImage returned error)
DB	Flash update is failed
DC	Reset protocol is not available

## ACPI/ASL Checkpoints (under OS)

Code	Description
03	System is entering S3 sleep state
04	System is entering S4 sleep state
05	System is entering S5 sleep state
30	System is waking up from the S3 sleep state
40	System is waking up from the S4 sleep state
AC	System has transitioned into ACPI mode. Interrupt controller is in PIC mode.
AA	System has transitioned into ACPI mode. Interrupt controller is in APIC mode.

## 1.2.9 Internal connectors

### 1. Intel® Z170 Serial ATA 6 Gb/s connectors (7-pin SATA6G\_1-6)

These connectors connect to Serial ATA 6 Gb/s hard disk drives via Serial ATA 6 Gb/s signal cables.

If you installed Serial ATA hard disk drives, you can create a RAID 0, 1, 5, and 10 configuration with the Intel® Rapid Storage Technology through the onboard Intel® Z170 chipset.

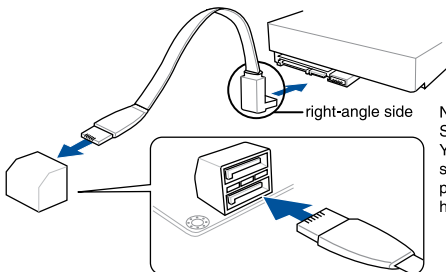
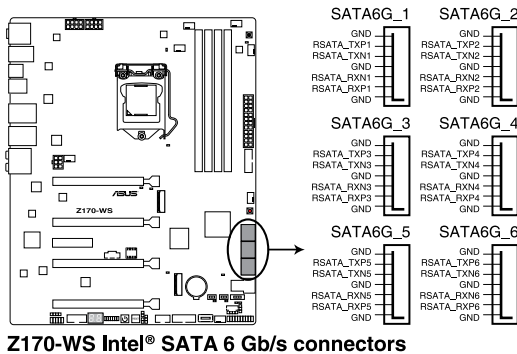

NOTE: Connect the right-angle side of SATA signal cable to SATA device. You may also connect the right-angle side of SATA cable to the onboard SATA port to avoid mechanical conflict with huge graphics cards.



- These connectors are set to **[AHCI Mode]** by default. If you intend to create a Serial ATA RAID set using these connectors, set the SATA Mode item in the BIOS to **[RAID Mode]**. Refer to section 3.6.4 PCH Configuration for details.
- Before creating a RAID set, refer to section 5.1 RAID configurations or the manual bundled in the motherboard support DVD.
- ASMedia storage controller can only support AHCI mode.
- These SATA ports are for data drives only.



The M.2\_1 socket shares SATA ports with SATA6G\_56; the M.2\_2 socket shares bandwidth with U.2 connector, and shares SATA ports with SATA6G\_12 when using SATA mode. When you use both connectors, the system automatically detects the devices connected to these connectors and set a higher priority to M.2 Socket 3 than SATA interface. You can adjust the BIOS settings to set the priority.

## 2. U.2 connector (U.2)

This motherboard comes with a U.2 connector which supports PCIe 3.0 x4 NVM Express storage.

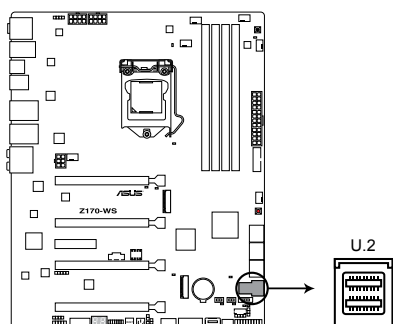

**Z170-WS U.2 connector**

## 3. Digital audio connector (4-1 pin SPDIF\_OUT)

This connector is for an additional Sony/Philips Digital Interface (S/PDIF) port. Connect the S/PDIF Out module cable to this connector, then install the module to a slot opening at the back of the system chassis.

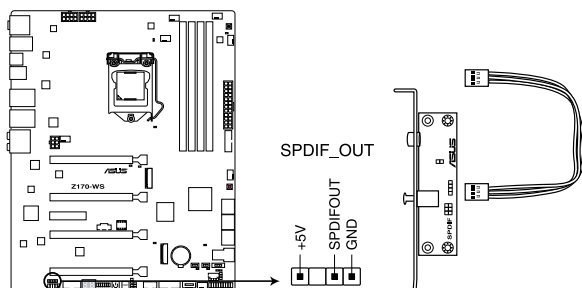

**Z170-WS Digital audio connector**





---

The S/PDIF module is purchased separately.

---

#### 4. Front panel audio connector (10-1 pin AAFP)

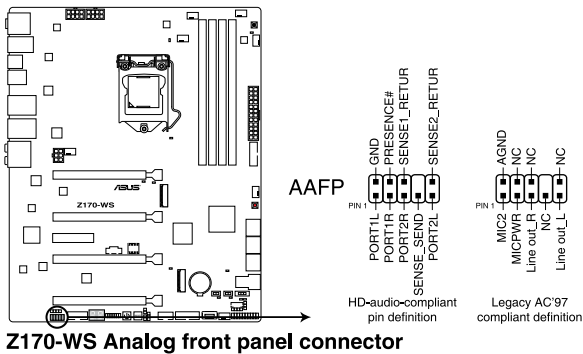
This connector is for a chassis-mounted front panel audio I/O module that supports either HD Audio or legacy AC'97 audio standard. Connect one end of the front panel audio I/O module cable to this connector.



**Z170-WS Analog front panel connector**



- We recommend that you connect a high-definition front panel audio module to this connector to avail of the motherboard's high-definition audio capability.
- If you want to connect a high-definition or an AC'97 front panel audio module to this connector, set the Front Panel Type item in the BIOS setup to **[HD Audio]** or **[AC97]**.

#### 5. T\_Sensor connector (2-pin T\_SENSOR1)

This connector is for the thermistor cable that allows you to monitor the temperature of your motherboard's critical components and connected devices.

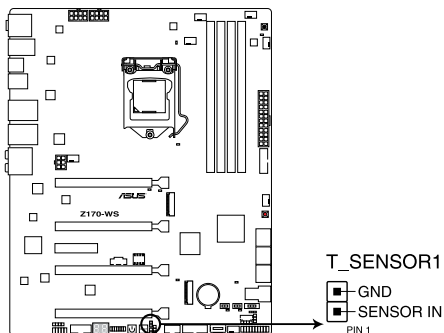

**Z170-WS T\_SENSOR connector**

## 6. Chassis intrusion connector (4-1 pin CHASSIS)

This connector is for a chassis-mounted intrusion detection sensor or switch. Connect one end of the chassis intrusion sensor or switch cable to this connector. The chassis intrusion sensor or switch sends a high-level signal to this connector when a chassis component is removed or replaced. The signal is then generated as a chassis intrusion event.

By default, the pin labeled “Chassis Signal” and “Ground” are shorted with a jumper cap. Remove the jumper caps only when you intend to use the chassis intrusion detection feature.

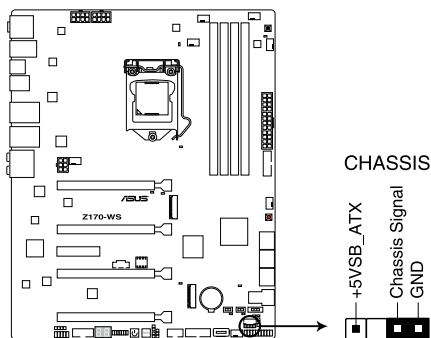

**Z170-WS Chassis intrusion connector**

## 7. TPM connector (14-1 pin TPM)

This connector supports a Trusted Platform Module (TPM) system, which securely store keys, digital certificates, passwords and data. A TPM system also helps enhance network security, protect digital identities, and ensures platform integrity.

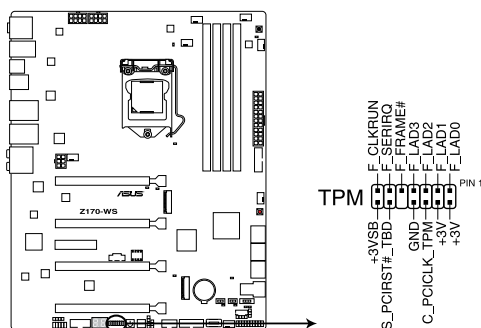

**Z170-WS TPM connector**



The TPM module is purchased separately.

## 8. USB 3.0 connectors (20-pin USB3\_12; USB3\_34; USB3\_5)

These connectors allow you to connect a USB 3.0 module for additional USB 3.0 front or rear panel ports. With an installed USB 3.0 module, you can enjoy all the benefits of USB 3.0 including faster data transfer speeds of up to 5 Gb/s, faster charging time for USB-chargable devices, optimized power efficiency, and backward compatibility with USB 2.0.

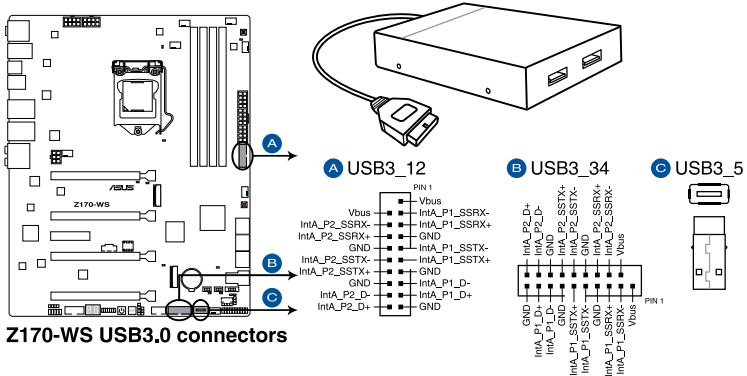

The USB 3.0 module is purchased separately.



- These connectors are based on xHCI specification. We recommend you to install the related driver to fully use the USB 3.0 ports under Windows® 7.
- The plugged USB 3.0 device may run on xHCI or EHCI mode depending on the operating system's setting.
- These USB 3.0 ports only support Turbo Mode when using USB 3.0 Boost feature.

## 9. USB 2.0 connectors (10-1 pin USB1112)

These connectors are for USB 2.0 ports. Connect the USB module cable to any of these connectors, then install the module to a slot opening at the back of the system chassis. These USB connectors comply with USB 2.0 specification that supports up to 480 Mbps connection speed.

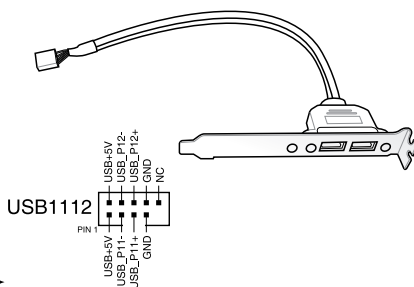
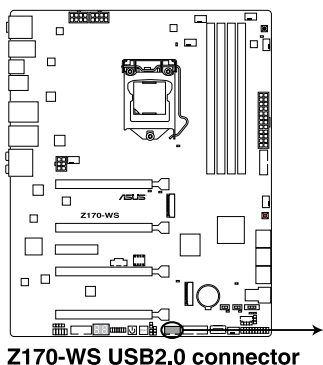

DO NOT connect a 1394 cable to the USB connectors. Doing so will damage the motherboard!



You can connect the front panel USB cable to the ASUS Q-Connector (USB) first, and then install the Q-Connector (USB) to the USB connector onboard if your chassis supports front panel USB ports.



The USB 2.0 module is purchased separately.



## 10. CPU, water pump, CPU optional, extension, and chassis fan connectors (4-pin CPU\_FAN; 4-pin W\_PUMP; 4-pin CPU\_OPT; 5-pin EXT\_FAN; 4-pin CHA\_FAN1-4)

Connect the fan cables to the fan connectors on the motherboard, ensuring that the black wire of each cable matches the ground pin of the connector.



- DO NOT forget to connect the fan cables to the fan connectors. Insufficient air flow inside the system may damage the motherboard components. These are not jumpers! Do not place jumper caps on the fan connectors!
- Ensure that the CPU fan cable is securely installed to the CPU fan connector.

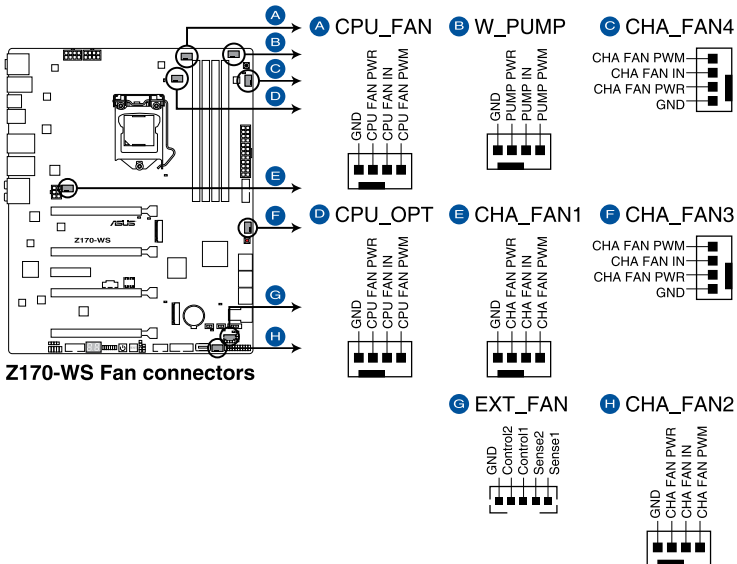

- The CPU\_FAN connector supports the CPU fan of maximum 1A (12 W) fan power.
- The CPU\_FAN connector and CHA\_FAN connectors support the ASUS FAN Xpert 3 feature.
- W\_PUMP function support depends on water cooling device.
- The CPU fan connector detects the type of CPU fan installed and automatically switches the control modes. To configure the CPU fan's control mode, go to **Advanced Mode > Monitor > CPU Q-Fan Control** item in BIOS.
- The chassis fan connectors support DC and PWM modes. To set these fans to DC or PWM, go to **Advanced Mode > Monitor > Chassis Fan 1/4 Q-Fan Control** items in BIOS.

## 11. ATX power connectors (24-pin EATXPWR; 8-pin EATX12V1, 8-pin EATX12V, 6-pin EATX12V\_1)

These connectors are for ATX power supply plugs. The power supply plugs are designed to fit these connectors in only one orientation. Find the proper orientation and push down firmly until the connectors completely fit.

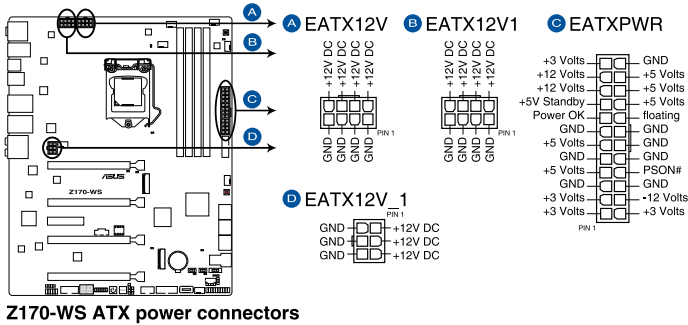

**Z170-WS ATX power connectors**



- For a fully configured system, we recommend that you use a power supply unit (PSU) that complies with ATX 12 V Specification 2.0 (or later version) and provides a minimum power of 350 W.
- DO NOT forget to connect the 4-pin/8-pin EATX12 V power plug. Otherwise, the system will not boot.
- We recommend that you use a PSU with a higher power output when configuring a system with more power-consuming devices. The system may become unstable or may not boot up if the power is inadequate.
- If you want to use two or more high-end PCI Express x16 cards, use a PSU with 1000W power or above to ensure the system stability.

## 12. System panel connector (20-5 pin PANEL)

This connector supports several chassis-mounted functions.

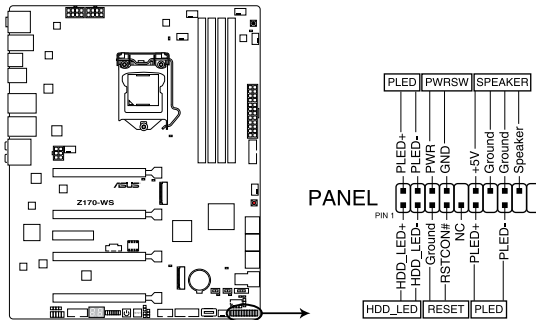

**Z170-WS System panel connector**

- **System power LED (3-1 pin or 2-pin PLED)**

This 3-1 pin or 2-pin connector is for the system power LED. Connect the chassis power LED cable to this connector. The system power LED lights up when you turn on the system power, and blinks when the system is in sleep mode.

- **Hard disk drive activity LED (2-pin HDD\_LED)**

This 2-pin connector is for the HDD Activity LED. Connect the HDD Activity LED cable to this connector. The HDD LED lights up or flashes when data is read from or written to the HDD.

- **System warning speaker (4-pin SPEAKER)**

This 4-pin connector is for the chassis-mounted system warning speaker. The speaker allows you to hear system beeps and warnings.

- **ATX power button/soft-off button (2-pin PWRSW)**

This connector is for the system power button. Pressing the power button turns the system on or puts the system in sleep or soft-off mode depending on the operating system settings. Pressing the power switch for more than four seconds while the system is ON turns the system OFF.

- **Reset button (2-pin RESET)**

This 2-pin connector is for the chassis-mounted reset button for system reboot without turning off the system power.

### 13. DirectKey connector (2-pin DRCT)

This connector is for the chassis-mounted button that supports the DirectKey function. Connect the button cable that supports DirectKey, from the chassis to this connector on the motherboard.

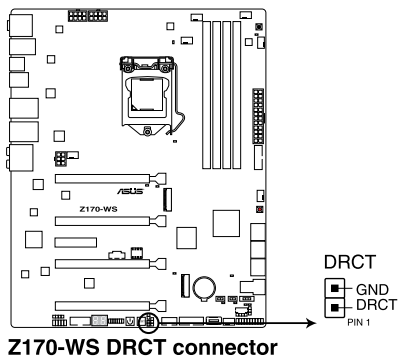

Ensure that your chassis comes with the extra button cable that supports the DirectKey feature. Refer to the technical documentation that came with the chassis for details.

### 14. Thunderbolt header (5-pin TB\_HEADER)

This connector is for the add-on Thunderbolt I/O card that supports Intel's Thunderbolt Technology, allowing you to connect up to six Thunderbolt-enabled devices and a DisplayPort-enabled display in a daisy-chain configuration.

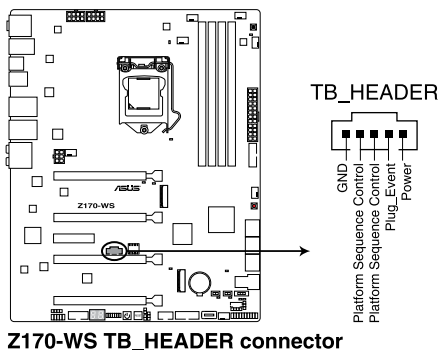

The add-on Thunderbolt I/O card and Thunderbolt cables are purchased separately.

## 15. M.2 socket 3

This socket allows you to install an M.2 (NGFF) SSD module.

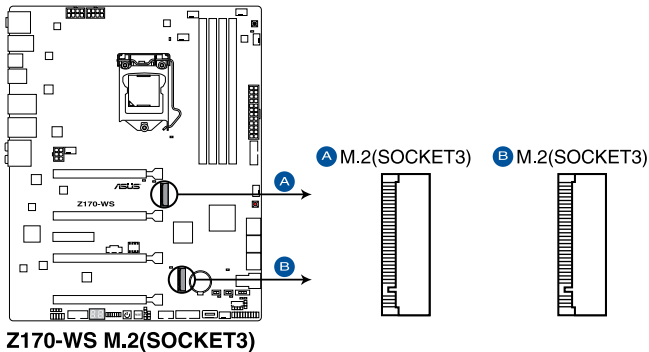

- This socket supports M Key and type 2242/2260/2280/22110 storage devices.
- The M.2 X4\_1 shares bandwidth with SATA6G\_56. Refer to section **3.6.4 PCH Configuration** of this user guide for more details. When you use both connectors, the system automatically detects the devices connected to these connectors and set a higher priority to M.2 Socket 3 than SATA interface. You can adjust the BIOS settings to set the priority.
- M.2 X4\_2 SATA mode shares bandwidth with SATA6G\_12. When you use both connectors, the system automatically detects the devices connected to these connectors and set a higher priority to M.2 Socket 3 than SATA interface. You can adjust the BIOS settings to set the priority.
- M.2 X4\_2 PCIe mode shares bandwidth with U.2. When you use both connectors, the system automatically detects the devices connected to these connectors and set a higher priority to M.2 Socket 3 than U.2 interface. You can adjust the BIOS settings to set the priority.
- When using Intel® Desktop Responsiveness technologies with PCIe M.2 device, ensure to set up the Windows® UEFI operating system under RAID mode.



The M.2 (NGFF) SSD module is purchased separately.

## 16. Serial port connector (10-1 pin COM1)

This connector is for a serial (COM) port. Connect the serial port module cable to this connector, then install the module to a slot opening at the back of the system chassis.

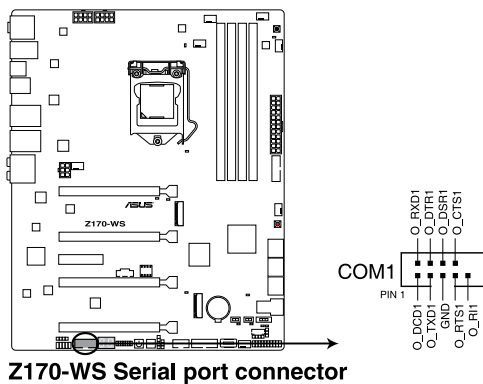

---

The COM module is purchased separately.

---

# Basic Installation

# 2

## 2.1 Building your PC system



The diagrams in this section are for reference only. The motherboard layout may vary with models, but the installation steps are the same for all models.

### 2.1.1 Motherboard installation

1. Install the ASUS Q-Shield to the chassis rear I/O panel.

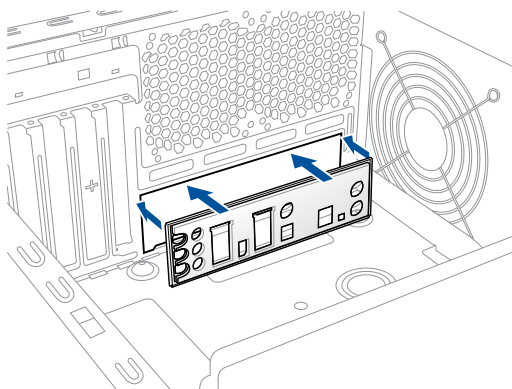

2. Place the motherboard into the chassis, ensuring that its rear I/O ports are aligned to the chassis' rear I/O panel.

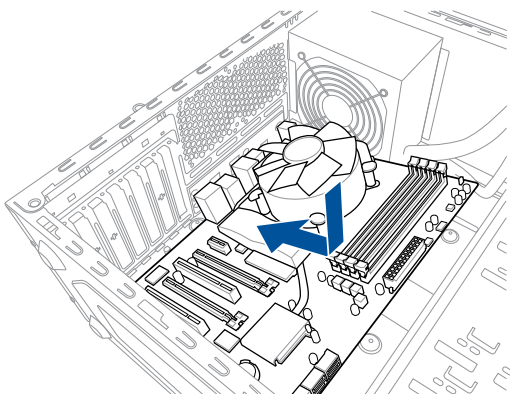

3. Place nine screws into the holes indicated by circles to secure the motherboard to the chassis.

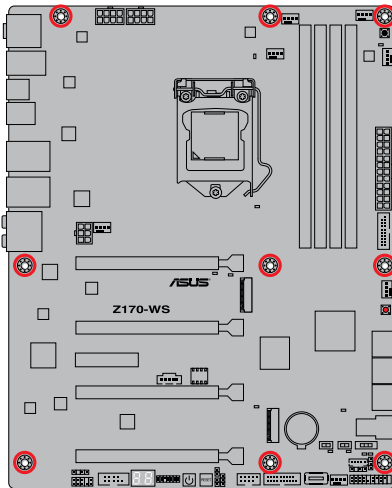
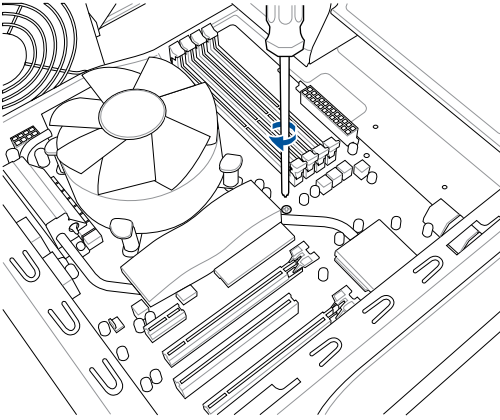

DO NOT overtighten the screws! Doing so can damage the motherboard.



## 2.1.2 CPU installation



Ensure that you install the correct CPU designed for LGA1151 socket only. DO NOT install a CPU designed for LGA1155 and LGA1156 sockets on the LGA1151 socket.

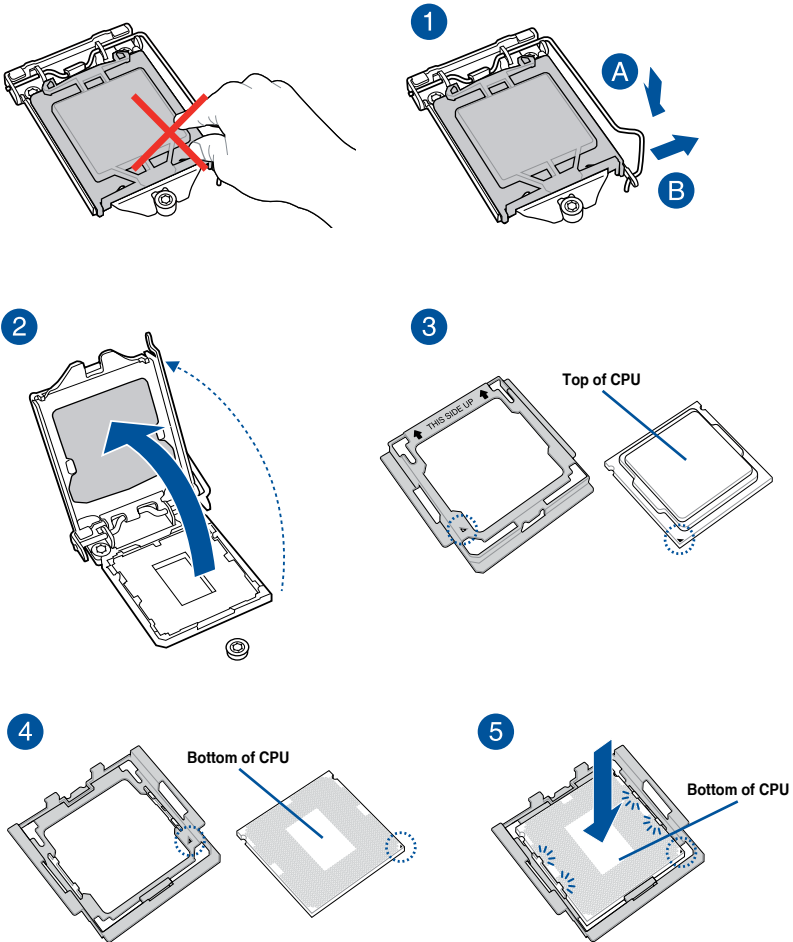

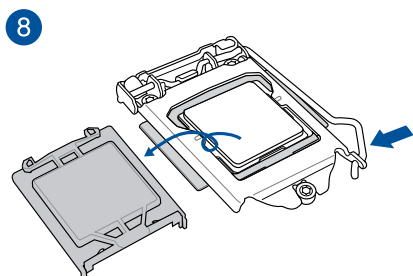
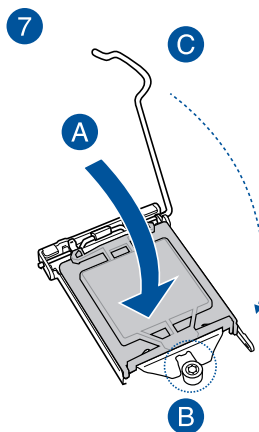
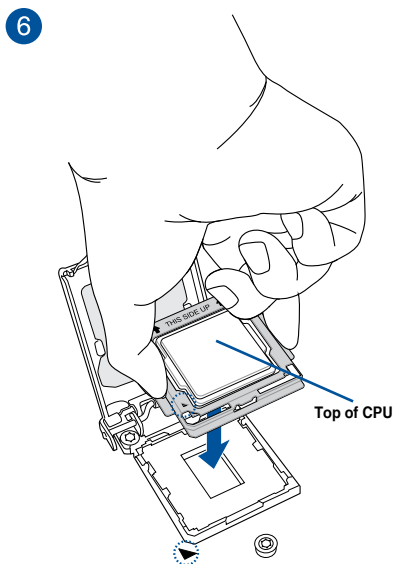

- The CPU Installation Tool is only compatible on ASUS motherboards with a Intel® LGA1151 socket.
- Ensure that the CPU is firmly clicked into place before installing it onto the CPU socket on the motherboard.
- Use the CPU Installation Tool for installing the CPU only. DO NOT damage or bend the CPU Installation Tool.
- Always firmly hold both sides of the CPU Installation Tool when installing, removing, or picking up the CPU Installation Tool.
- Ensure to use a soft stable surface when installing the CPU to the CPU Installation Tool to prevent CPU damage.
- ASUS will not cover damages resulting from incorrect CPU installation/removal, incorrect CPU orientation/placement, or other damages resulting from negligence by the user.

## 2.1.3 CPU heatsink and fan assembly installation

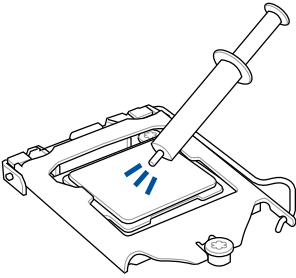

Apply the Thermal Interface Material to the CPU heatsink and CPU before you install the heatsink and fan, if necessary.

To install the CPU heatsink and fan assembly

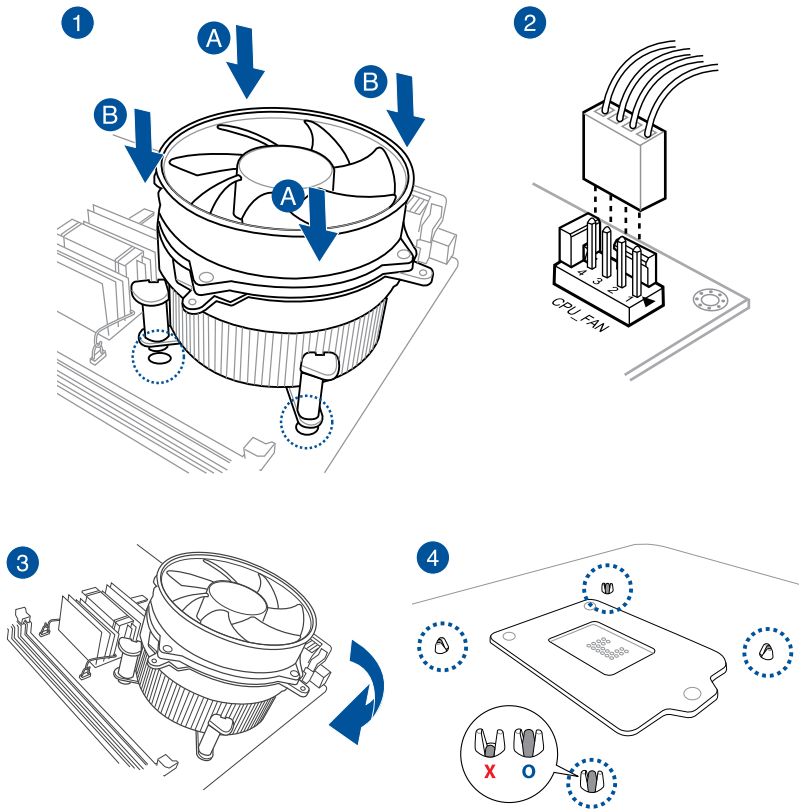

To uninstall the CPU heatsink and fan assembly

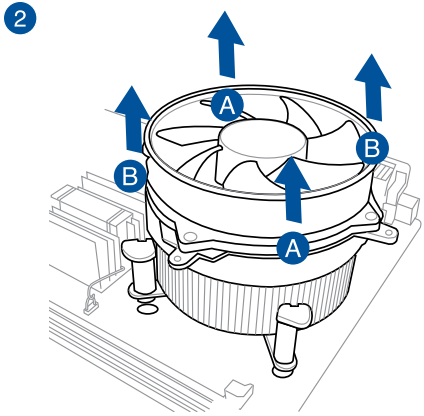
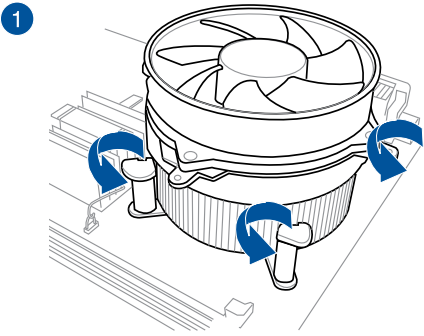

## 2.1.4 DIMM installation

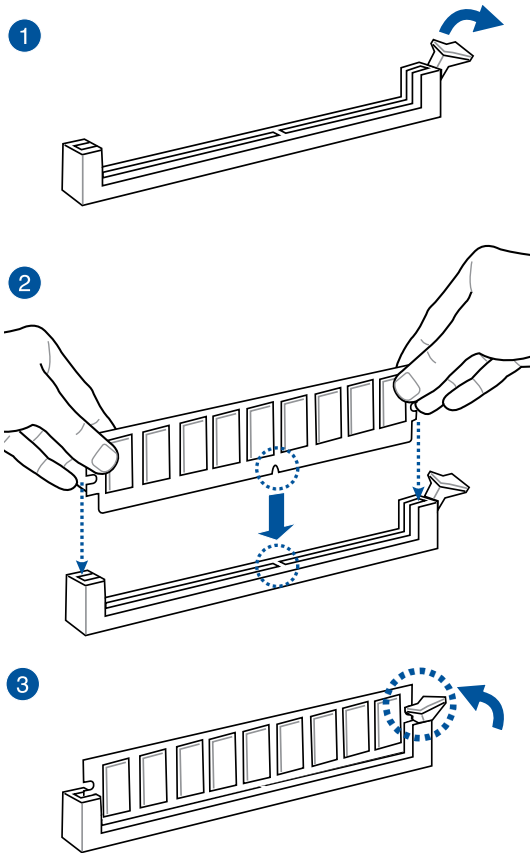

### To remove a DIMM

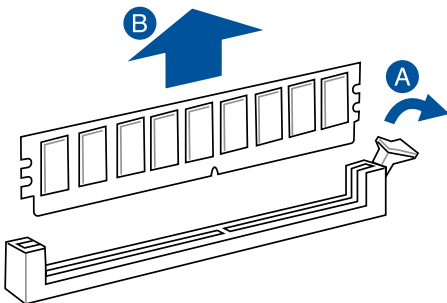

## 2.1.5 ATX Power connection

1

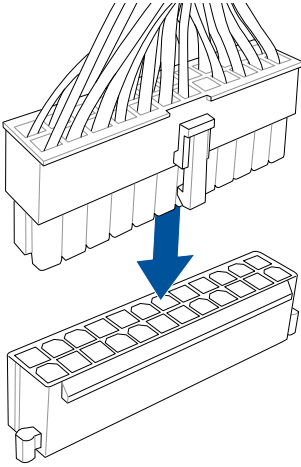

2

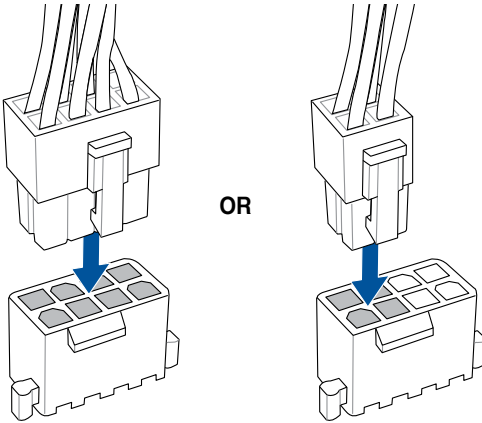

## 2.1.6 SATA device connection

1

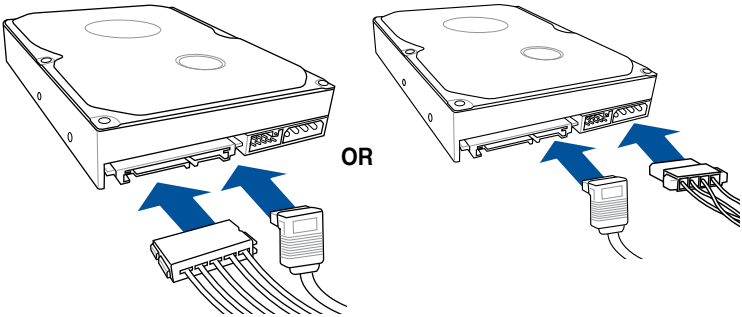

2

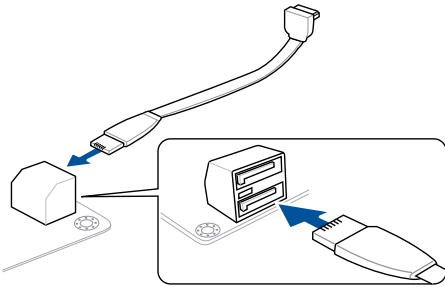

OR

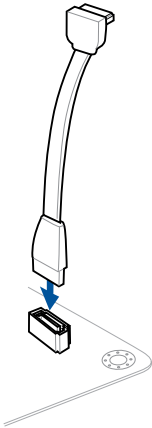

## 2.1.7 Front I/O connector

### To install ASUS Q-Connector

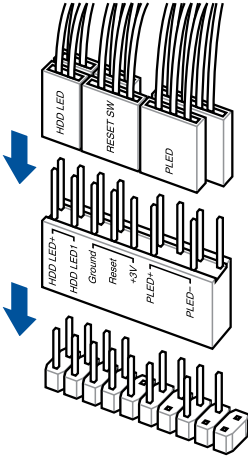

### To install USB 2.0 connector

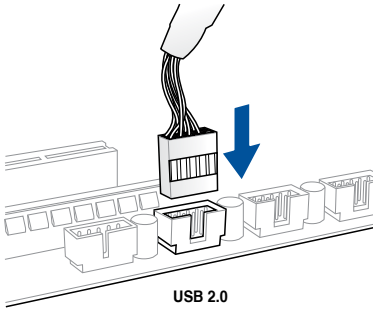

### To install front panel audio connector

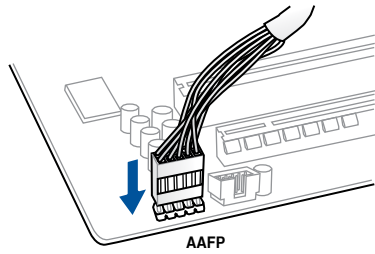

### To install USB 3.0 connector

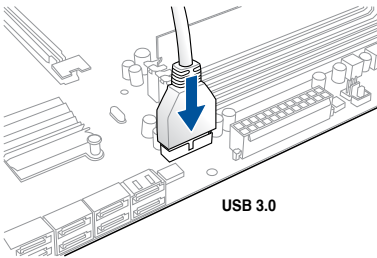



## 2.1.8 Expansion Card installation

To install PCIe x16 cards

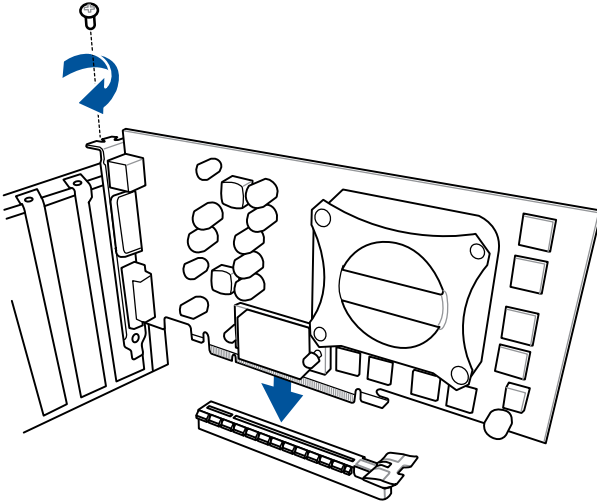

To install PCIe x1 cards

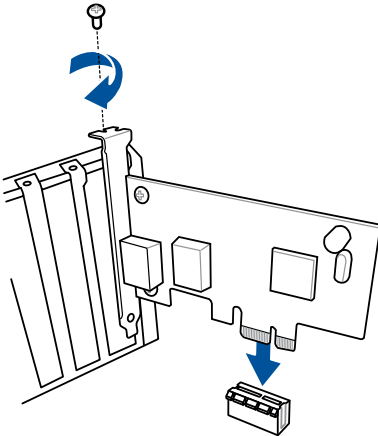

## 2.2 BIOS update utility

### USB BIOS Flashback

USB BIOS Flashback allows you to easily update the BIOS without entering the existing BIOS or operating system. Simply insert a USB storage device to the USB port (the USB port hole marked in white on the I/O shield) then press the USB BIOS Flashback button for three seconds to automatically update the BIOS.

#### To use USB BIOS Flashback:

1. Place the bundled support DVD to the optical drive and install the USB BIOS Flashback Wizard. Follow the onscreen instructions to complete the installation.
2. Insert the USB storage device to the USB Flashback port.



- We recommend you to use a USB 2.0 storage device to save the latest BIOS version for better compatibility and stability.
- Refer to section 2.3.1 **Rear I/O connection** for the location of the USB port that supports USB BIOS Flashback.

3. Launch the USB BIOS Flashback Wizard to automatically download the latest BIOS version.
4. Shut down your computer.
5. Press the BIOS Flashback button at the rear panel for three seconds until the Flashback LED blinks three times, indicating that the BIOS Flashback function is enabled.

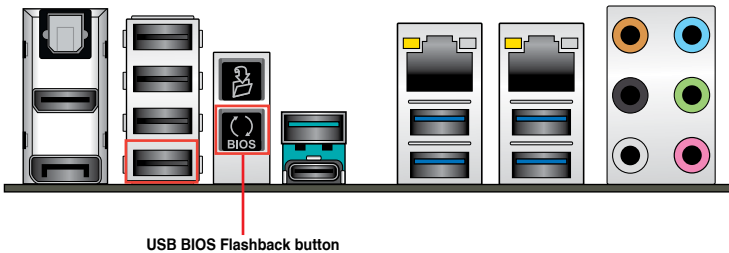

- Wait until the light goes out, indicating that the BIOS updating process is completed.



For more BIOS update utilities in BIOS setup, refer to the section **3.11 Updating BIOS** in Chapter 3.



- Do not unplug portable disk, power system, or press the CLR\_CMOS button while BIOS update is ongoing, otherwise update will be interrupted. In case of interruption, please follow the steps again.
- If the light flashes for five seconds and turns into a solid light, this means that the BIOS Flashback is not operating properly. This may be caused by improper installation of the USB storage device and filename/file format error. If this scenario happens, please restart the system to turn off the light.
- Updating BIOS may have risks. If the BIOS program is damaged during the process and results to the system's failure to boot up, please contact your local ASUS Service Center.

## Q-Code Logger

Q-Code Logger allows you to easily check Q-Code event logs with opening the computer's case. Simply insert a USB storage device to the USB port (the USB port hole marked in green on the I/O shield) then press the USB BIOS Flashback button for three seconds to automatically store the Q-Code event logs.

### To use Q-Code Logger:

- Insert the USB storage device to the Q-Code Logger port.
- Press the Q-Code Logger button at the rear panel for three seconds until the Flashback LED blinks three times, indicating that the Q-Code Logger function is enabled.

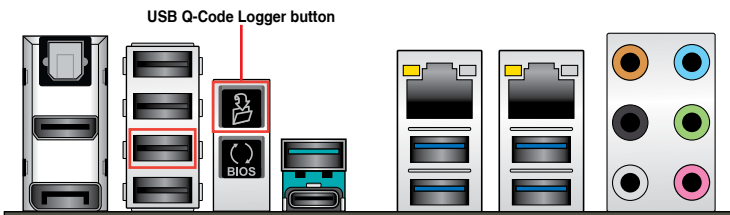

Q-Code Logger does not support NTFS and exFAT32 format. Ensure that your USB flash drive is in single partition and in FAT32 format.

## 2.3 Motherboard rear and audio connections

### 2.3.1 Rear I/O connection

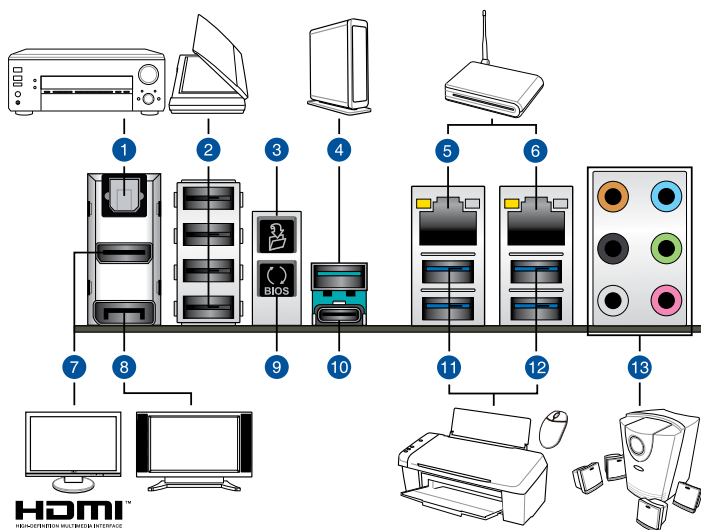

#### Rear panel connectors

1. Optical S/PDIF Out port	8. DisplayPort
2. USB 2.0 ports 7-10 (upper port supports Key Express)	9. USB BIOS Flashback button
3. Q-Code Logger button	10. USB 3.1 Type-C port EC1 (supports USB 3.1 Boost)
4. USB 3.1 Type-A port EA2 (supports USB 3.1 Boost)	11. USB 3.0 ports 3 and 4
5. Intel® LAN port 1*	12. USB 3.0 ports 1 and 2
6. Intel® LAN port 2*	13. Audio I/O ports**
7. HDMI 2.0 port	

\* and \*\*: Refer to the tables on the next page for LAN port LEDs and audio port definitions.



- USB 3.0 devices can only be used as data storage only.
- We strongly recommend that you connect USB 3.1/3.0 devices to USB 3.1/3.0 ports for faster and better performance for your USB devices.
- Multi-VGA output supports up to two displays under Windows® OS environment or BIOS, and one display under DOS.
- Intel display architecture design supports the following maximum supported pixel clocks (Pixel Clock = H total x V Total x Frame Rate (Fresh screen rate)):
  - DisplayPort / Mini DisplayPort: 675 MHz
  - HDMI 2.0 port: 594 MHz

### \* LAN ports LED indications

Activity Link LED		Speed LED	
Status	Description	Status	Description
Off	No link	Off	10 Mbps connection
Orange	Linked	Orange	100 Mbps connection
Orange (Blinking)	Data activity	Green	1 Gbps connection
Orange (Blinking then steady)	Ready to wake up from S5 mode		

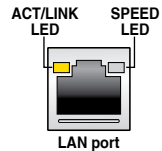

You can disable the LAN controllers in BIOS. Once disabled, the LAN2 port's ACT/LINK LED and SPEED LED stop blinking. For LAN1 port, the ACT/LINK LED still blinks even if you disabled it.

**\*\* Audio 2, 4, 6, or 8-channel configuration**

Port	Headset 2-channel	4-channel	6-channel	8-channel
Light Blue	Line In	Line In	Line In	Line In
Lime	Line Out	Front Speaker Out	Front Speaker Out	Front Speaker Out
Pink	Mic In	Mic In	Mic In	Mic In
Orange	–	–	Center/Subwoofer	Center/Subwoofer
Black	–	Rear Speaker Out	Rear Speaker Out	Rear Speaker Out
Gray	–	–	Side Speaker Out*	Side Speaker Out

\* For Windows® 8.1 only

## 2.3.2 Audio I/O connections

### Audio I/O ports

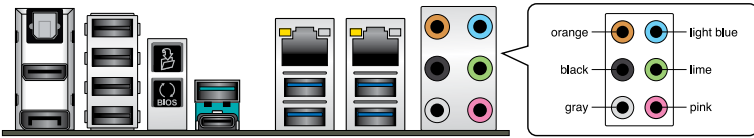

### Connect to Headphone and Mic



### Connect to Stereo Speakers

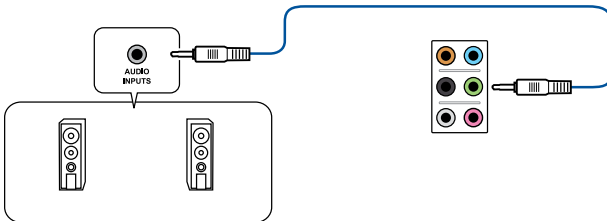

### Connect to 2.1 channel Speakers

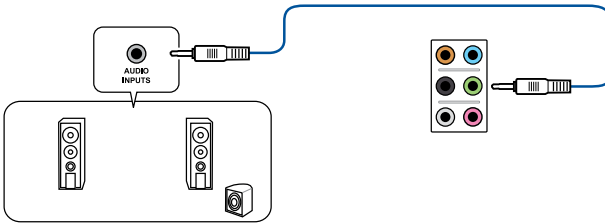

### Connect to 4.1 channel Speakers

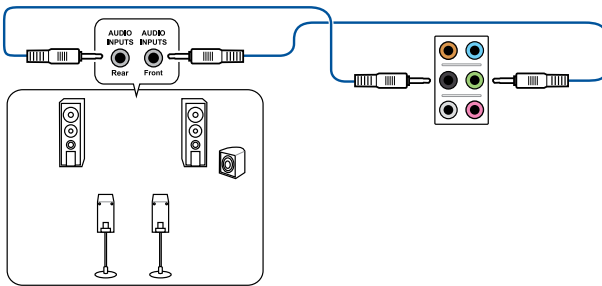

### Connect to 5.1 channel Speakers

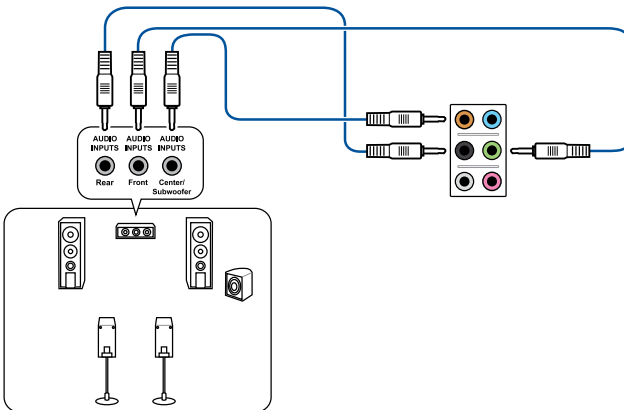

If you are using Windows 8.1 platform, use only the gray audio port for Side Speaker Out in a 6-channel configuration.

## Connect to 7.1 channel Speakers

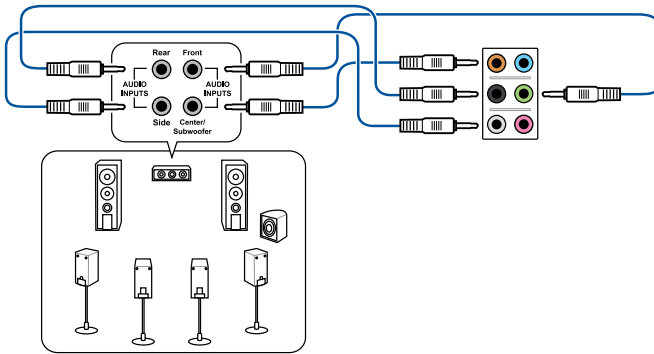

When the DTS UltraPC II function is enabled, ensure to connect the rear speaker to the gray port.

## 2.4 Starting up for the first time

1. After making all the connections, replace the system case cover.
2. Ensure that all switches are off.
3. Connect the power cord to the power connector at the back of the system chassis.
4. Connect the power cord to a power outlet that is equipped with a surge protector.
5. Turn on the devices in the following order:
  - a. Monitor
  - b. External SCSI devices (starting with the last device on the chain)
  - c. System power
6. After applying power, the system power LED on the system front panel case lights up. For systems with ATX power supplies, the system LED lights up when you press the ATX power button. If your monitor complies with the “green” standards or if it has a “power standby” feature, the monitor LED may light up or change from orange to green after the system LED turns on.

The system then runs the power-on self tests (POST). While the tests are running, the BIOS beeps (refer to the BIOS beep codes table) or additional messages appear on the screen. If you do not see anything within 30 seconds from the time you turned on the power, the system may have failed a power-on test. Check the jumper settings and connections or call your retailer for assistance.



BIOS Beep	Description
One short beep	VGA detected Quick boot set to disabled No keyboard detected
One continuous beep followed by two short beeps then a pause (repeated)	No memory detected
One continuous beep followed by three short beeps	No VGA detected
One continuous beep followed by four short beeps	Hardware component failure

7. At power on, hold down the <Delete> key to enter the BIOS Setup. Follow the instructions in Chapter 3.

## 2.5 Turning off the computer

While the system is ON, press the power button for less than four seconds to put the system on sleep mode or soft-off mode, depending on the BIOS setting. Press the power switch for more than four seconds to let the system enter the soft-off mode regardless of the BIOS setting.



# BIOS Setup

# 3

## 3.1 Knowing BIOS



---

The new ASUS UEFI BIOS is a Unified Extensible Interface that complies with UEFI architecture, offering a user-friendly interface that goes beyond the traditional keyboard-only BIOS controls to enable a more flexible and convenient mouse input. You can easily navigate the new UEFI BIOS with the same smoothness as your operating system. The term "BIOS" in this user manual refers to "UEFI BIOS" unless otherwise specified.

---

BIOS (Basic Input and Output System) stores system hardware settings such as storage device configuration, overclocking settings, advanced power management, and boot device configuration that are needed for system startup in the motherboard CMOS. In normal circumstances, the default BIOS settings apply to most conditions to ensure optimal performance. **DO NOT change the default BIOS settings** except in the following circumstances:

- An error message appears on the screen during the system bootup and requests you to run the BIOS Setup.
- You have installed a new system component that requires further BIOS settings or update.



---

Inappropriate BIOS settings may result to instability or boot failure. **We strongly recommend that you change the BIOS settings only with the help of a trained service personnel.**

---



---

When downloading or updating the BIOS file, rename it as **Z170WS.CAP** for this motherboard.

---

## 3.2 BIOS setup program

Use the BIOS Setup to update the BIOS or configure its parameters. The BIOS screen include navigation keys and brief onscreen help to guide you in using the BIOS Setup program.

### Entering BIOS at startup

To enter BIOS Setup at startup, press <Delete> during the Power-On Self Test (POST). If you do not press <Delete>, POST continues with its routines.

### Entering BIOS Setup after POST

To enter BIOS Setup after POST:

- Press <Ctrl>+<Alt>+<Delete> simultaneously.
- Press the reset button on the system chassis.
- Press the power button to turn the system off then back on. Do this option only if you failed to enter BIOS Setup using the first two options.

After doing either of the three options, press <Delete> key to enter BIOS.



- 
- The BIOS setup screens shown in this section are for reference purposes only, and may not exactly match what you see on your screen.
  - Ensure that a USB mouse is connected to your motherboard if you want to use the mouse to control the BIOS setup program.
  - If the system becomes unstable after changing any BIOS setting, load the default settings to ensure system compatibility and stability. Select the **Load Optimized Defaults** item under the **Exit** menu or press hotkey <F5>. See section 3.10 **Exit Menu** for details.
  - If the system fails to boot after changing any BIOS setting, try to clear the CMOS and reset the motherboard to the default value. See section 1.2.6 **Onboard buttons and switches** for information on how to erase the RTC RAM via the Clear CMOS button.
  - The BIOS setup program does not support the Bluetooth devices.
- 

### BIOS menu screen

The BIOS Setup program can be used under two modes: **EZ Mode** and **Advanced Mode**. You can change modes from **Setup Mode** in **Boot menu** or by pressing the <F7> hotkey.

### 3.2.1 EZ Mode

By default, the EZ Mode screen appears when you enter the BIOS setup program. The EZ Mode provides you an overview of the basic system information, and allows you to select the display language, system performance, mode and boot device priority. To access the Advanced Mode, select **Advanced Mode** or press the <F7> hotkey for the advanced BIOS settings.



The default screen for entering the BIOS setup program can be changed. Refer to the **Setup Mode** item in section **Boot menu** for details.

The screenshot shows the ASUS UEFI BIOS Utility - EZ Mode interface. The top bar displays the date (02/04/2009), time (23:40), language (English), and EZ Tuning Wizard (F11). The main area is divided into several sections: Information (Z170-WS, BIOS Ver. 0204, Intel(R) Core(TM) i5-6600K CPU @ 3.50GHz, Speed: 3500 MHz, Memory: 4096 MB (DDR4 2133MHz)), CPU Temperature (49°C), CPU Core Voltage (1.184 V), Motherboard Temperature (38°C), DRAM Status (DIMM\_A1: Panram 4096MB 2133MHz, DIMM\_A2: N/A, DIMM\_B1: N/A, DIMM\_B2: N/A), SATA Information (P1: N/A, P2: N/A, P3: N/A, P4: N/A, P5: N/A, P6: N/A), X.M.P. (Disabled), FAN Profile (CPU FAN 3183 RPM, CHA1 FAN N/A, CHA2 FAN N/A, CHA3 FAN N/A, CHA4 FAN N/A, CPU OPT FAN N/A, EXT FAN1 N/A, EXT FAN2 N/A), Intel Rapid Storage Technology (On), CPU FAN graph (0-100% vs 0-100°C), EZ System Tuning (Normal), Boot Priority (IBA CL Slot 00FE v0104), and Boot Menu (F8). The bottom bar contains Default (F5), Save & Exit (F10), Advanced Mode (F7), and Search on FAQ.

Displays the system properties of the selected mode. Click < > to switch EZ System Tuning modes

Displays the CPU/motherboard temperature, CPU voltage output, CPU/chassis/power fan speed, and SATA information

Selects the display language of the BIOS setup program

Creates storage RAID and configures system overclocking

Enables or disables the SATA RAID mode for Intel Rapid Storage Technology

Displays the CPU Fan's speed. Click the button to manually tune the fans

Loads optimized default settings

Saves the changes and resets the system

Click to go to Advanced mode

Search on the FAQ

Click to display boot devices

Selects the boot device priority



The boot device options vary depending on the devices you installed to the system.

### 3.2.2 Advanced Mode

The Advanced Mode provides advanced options for experienced end-users to configure the BIOS settings. The figure below shows an example of the Advanced Mode. Refer to the following sections for the detailed configurations.



To switch from EZ Mode to Advanced Mode, click **Advanced Mode(F7)** or press the <F7> hotkey.

The screenshot shows the ASUS UEFI BIOS Utility in Advanced Mode. The interface is dark-themed with blue accents. At the top, there's a header with the ASUS logo and 'UEFI BIOS Utility - Advanced Mode'. Below this is a status bar showing the date and time (02/20/2014 00:40), language (English), and various function keys like MyFavorite(F3), Qfan Control(F6), EZ Tuning Wizard(F11), Quick Note(F9), and Hot Keys. The main menu includes 'My Favorites', 'Main', 'AI Tweaker', 'Advanced', 'Monitor', 'Boot', 'Tool', and 'Exit'. The 'AI Tweaker' section is expanded, showing settings for AI Overclock Tuner (set to Auto), ASUS MultiCore Enhancement (set to Manual), CPU Core Ratio (set to Auto), BCLK Frequency (set to Auto), DRAM Odd Ratio Mode (set to Enabled), DRAM Frequency (set to Auto), TPU (set to Keep Current Settings), EPU Power Saving Mode (set to Disabled), and CPU SVID Support (set to Auto). A 'Hardware Monitor' panel on the right displays CPU frequency (3500 MHz), temperature (26°C), BCLK (100.0 MHz), core voltage (1.200 V), and ratio (35x). It also shows memory frequency (2133 MHz) and voltage (1.200 V), and capacity (4096 MB). A 'Voltage' section shows +12V (+5V), 12.096 V (5.000 V), and +3.3V (3.328 V). At the bottom, there's a footer with 'Version 2.17.1246. Copyright (C) 2015 American Megatrends, Inc.', 'Last Modified', 'EzMode(F7)', and 'Search on FAQ'. A search bar is also present.

**Configuration fields**

**Pop-up Menu**

**Menu bar** Language MyFavorite(F3) Qfan Control(F6) EZ Tuning Wizard(F11) Quick Note(F9) Scroll bar Hot Keys

**My Favorites** Main **AI Tweaker** Advanced Monitor Boot Tool Exit

Target CPU Turbo-Mode Frequency : 3900MHz  
 Target DRAM Frequency : 2133MHz  
 Target Cache Frequency : 3900MHz

AI Overclock Tuner Auto

ASUS MultiCore Enhancement Auto  
 Manual

CPU Core Ratio Auto

BCLK Frequency : DRAM Frequency Ratio Auto

DRAM Odd Ratio Mode Enabled

DRAM Frequency Auto

TPU Keep Current Settings

EPU Power Saving Mode Disabled

CPU SVID Support Auto

**Hardware Monitor**

**CPU**

Frequency 3500 MHz Temperature 26°C

BCLK 100.0 MHz Core Voltage 1.200 V

Ratio 35x

**Memory**

Frequency 2133 MHz Voltage 1.200 V

Capacity 4096 MB

**Voltage**

+12V +5V  
 12.096 V 5.000 V

+3.3V  
 3.328 V

[Manual]: When the manual mode is selected, BCLK(base clock) frequency can be assigned manually.  
 [XMP]: When XMP(extreme memory profile) mode is selected, BCLK frequency and memory parameters will be optimized automatically.

Last Modified EzMode(F7) Search on FAQ

Version 2.17.1246. Copyright (C) 2015 American Megatrends, Inc.

**Menu items** **General help** **Last modified settings** **Go back to EZ Mode** **Search on the FAQ**

**Displays the CPU temperature, CPU, and memory voltage output**

## Menu bar

The menu bar on top of the screen has the following main items:

<b>My Favorites</b>	For saving the frequently-used system settings and configuration.
<b>Main</b>	For changing the basic system configuration
<b>Ai Tweaker</b>	For changing the overclocking settings
<b>Advanced</b>	For changing the advanced system settings
<b>Monitor</b>	For displaying the system temperature, power status, and changing the fan settings.
<b>Boot</b>	For changing the system boot configuration
<b>Tool</b>	For configuring options for special functions
<b>Exit</b>	For selecting the exit options and loading default settings

## Menu items

The highlighted item on the menu bar displays the specific items for that menu. For example, selecting **Main** shows the Main menu items.

The other items (My Favorites, Ai Tweaker, Advanced, Monitor, Boot, Tool, and Exit) on the menu bar have their respective menu items.

## Submenu items

A greater than sign (>) before each item on any menu screen means that the item has a submenu. To display the submenu, select the item and press <Enter>.

## Language

This button above the menu bar contains the languages that you can select for your BIOS. Click this button to select the language that you want to display in your BIOS screen.

## My Favorites (F3)

This button above the menu bar shows all BIOS items in a Tree Map setup. Select frequently-used BIOS settings and save it to MyFavorites menu.



---

Refer to section **3.3 My Favorites** for more information.

---

## Q-Fan Control (F6)

This button above the menu bar displays the current settings of your fans. Use this button to manually tweak the fans to your desired settings.



---

Refer to section **3.2.3 QFan Control** for more information.

---

## EZ Tuning Wizard (F11)

This button above the menu bar allows you to view and tweak the overclocking settings of your system. It also allows you to change the motherboard's SATA mode from AHCI to RAID mode.



---

Refer to section **3.2.4 EZ Tuning Wizard** for more information.

---

## Search on FAQ

Move your mouse over this button to show a QR code, scan this QR code on your mobile device to connect to the BIOS FAQ web page of the ASUS support website. You can also scan the following QR code:



## Quick Note (F9)

This button above the menu bar allows you to key in notes of the activities that you have done in BIOS.



- 
- The Quick Note function does not support the following keyboard functions: delete, cut, copy, and paste.
  - You can only use the alphanumeric characters to enter your notes.
- 

## Hot keys

This button above the menu bar contains the navigation keys for the BIOS setup program. Use the navigation keys to select items in the menu and change the settings.

## Scroll bar

A scroll bar appears on the right side of a menu screen when there are items that do not fit on the screen. Press the Up/Down arrow keys or <Page Up> / <Page Down> keys to display the other items on the screen.

## General help

At the top right corner of the menu screen is a brief description of the selected item. Use <F12> key to capture the BIOS screen and save it to the removable storage device.

## Configuration fields

These fields show the values for the menu items. If an item is user-configurable, you can change the value of the field opposite the item. You cannot select an item that is not user-configurable.

A configurable field is highlighted when selected. To change the value of a field, select it and press <Enter> to display a list of options.

## Last Modified button

This button shows the items that you last modified and saved in BIOS Setup.



### 3.2.3 QFan Control

The QFan Control allows you to set a fan profile or manually configure the operating speed of your CPU and chassis fans.

The screenshot shows the ASUS Q-Fan Control interface in the BIOS. The interface includes a fan selection list, a graph showing fan speed (%) vs. temperature (°C), and several control buttons. Red lines and boxes highlight specific features with the following annotations:

- Click to select a fan to be configured**: Points to the fan selection list on the left, which includes options like CPU FAN, CHA1 FAN, CHA2 FAN, CHA3 FAN, CHA4 FAN, EXT FAN1, EXT FAN2, and EXT FAN3.
- Click to activate PWM Mode**: Points to the 'PWM' button above the graph.
- Click to activate DC Mode**: Points to the 'DC' button above the graph.
- Select a profile to apply to your fans**: Points to the radio buttons for Standard, Silent, Turbo, Full Speed, and Manual.
- Click to apply the fan setting**: Points to the 'Apply' button.
- Click to go back to main menu**: Points to the 'Exit (ESC)' button.
- Click to undo the changes**: Points to the 'Undo' button.
- Select to manually configure your fans**: Points to the 'Manual' radio button.

## Configuring fans manually

Select **Manual** from the list of profiles to manually configure your fans' operating speed.

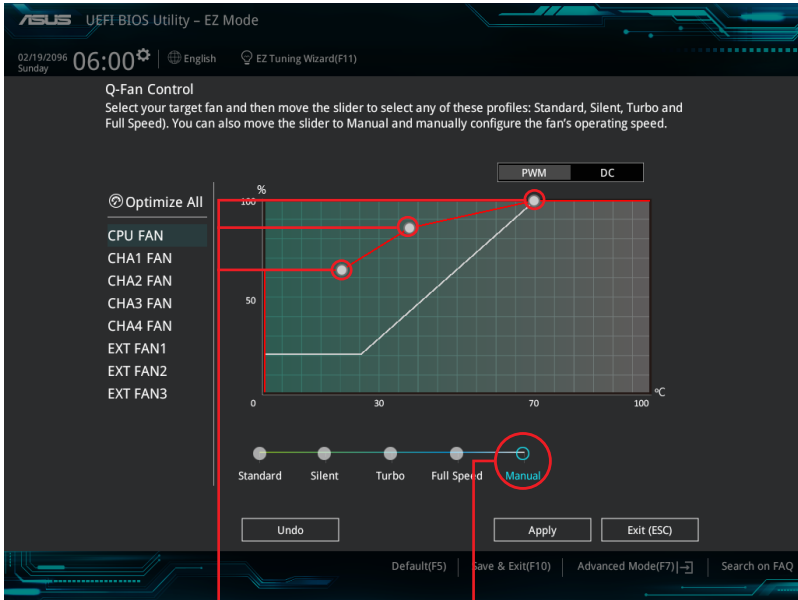

Speed points

Select to manually  
configure your fans

To configure your fans:

1. Select the fan that you want to configure and to view its current status.
2. Click and drag the speed points to adjust the fans' operating speed.
3. Click **Apply** to save the changes then click **Exit (ESC)**.

### 3.2.4 EZ Tuning Wizard

EZ Tuning Wizard allows you to easily overclock your CPU and DRAM, computer usage, and CPU fan to their best settings. You can also set RAID in your system using this feature.

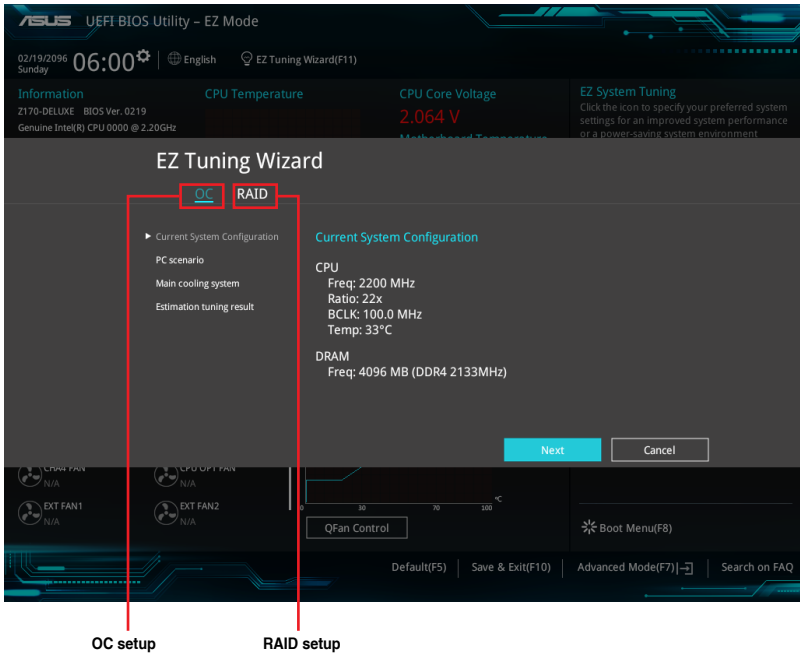

#### OC Tuning

To start OC Tuning:

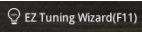
1. Press <F11> on your keyboard or click  from the BIOS screen to open EZ Tuning Wizard screen.
2. Click **OC** then click **Next**.
3. Select a PC scenario **Daily Computing** or **Gaming/Media Editing**, then click **Next**.

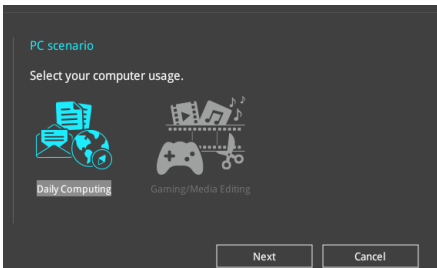

4. Select a Main Cooling System **BOX cooler**, **Tower cooler**, **Water cooler**, or **I'm not sure**, then click **Next**.

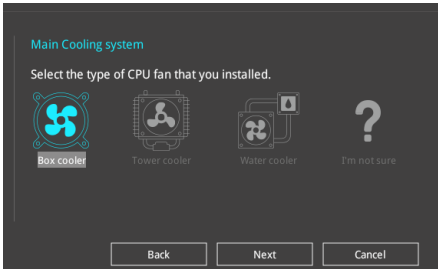

5. After selecting the Main Cooling System, click **Next** then click **Yes** to start the OC Tuning.

## Creating RAID

To create RAID:

1. Press <F11> on your keyboard or click **EZ Tuning Wizard(F11)** from the BIOS screen to open EZ Tuning Wizard screen.
2. Click **RAID** then click **Next**.



- Ensure that your HDDs have no existing RAID volumes.
- Ensure to connect your HDDs to Intel® SATA connectors.

3. Select the port that you want to set to [RAID] mode, **PCIe** or **SATA**, then click **Next**.

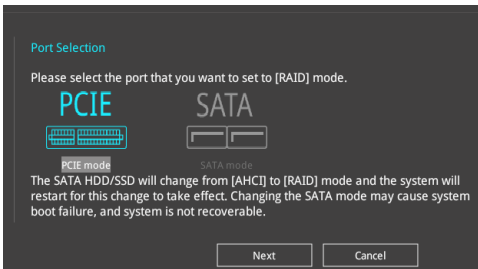

4. Select the type of storage for your RAID, **Easy Backup** or **Super Speed**, then click **Next**.

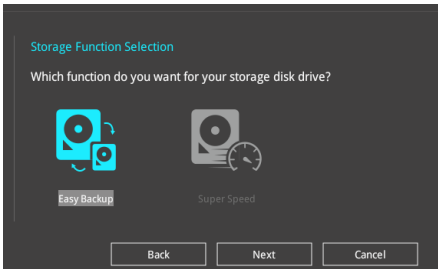

- a. For Easy Backup, click **Next** then select from **Easy Backup (RAID1)** or **Easy Backup (RAID10)**.

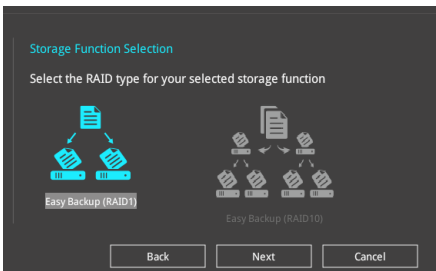

---

You can only select Easy Backup (RAID 10) if you connect four (4) HDDs.

---

- b. For Super Speed, click **Next** then select from **Super Speed (RAID0)** or **Super Speed (RAID5)**.

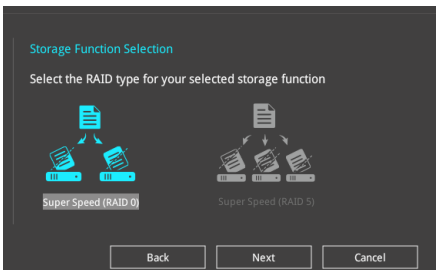

5. After selecting the type of RAID, click **Next** then click **Yes** to continue the RAID setup.
6. After the RAID setup is done, click **Yes** to exit the setup then click **OK** to reset your system.

### 3.3 My Favorites

My Favorites is your personal space where you can easily save and access your favorite BIOS items.





My Favorites comes with several performance, power saving, and fast boot related items by default. You can personalize this screen by adding or removing items.

## Adding items to My Favorites

To add BIOS items:

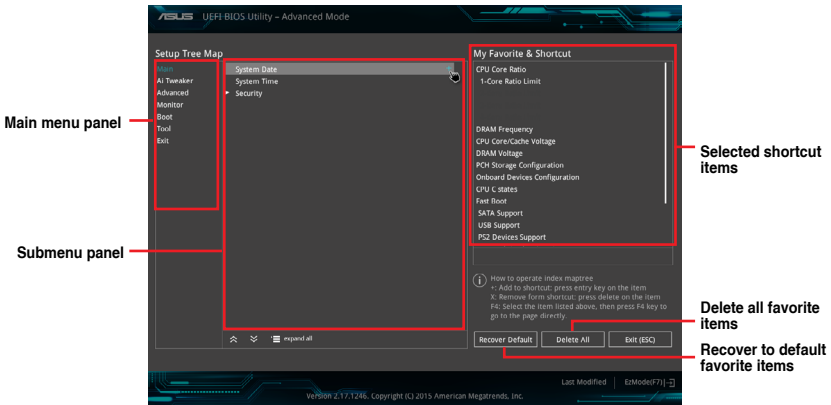
1. Press <F3> on your keyboard or click  (F3)MyFavorite from the BIOS screen to open Setup Tree Map screen.
2. On the Setup Tree Map screen, select the BIOS items that you want to save in My Favorites screen.



3. Select an item from main menu panel, then click the submenu that you want to save as favorite from the submenu panel and click  or press <Enter> on your keyboard.



You cannot add the following items to My Favorite items:

- Items with submenu options
- User-managed items such as language and boot order
- Configuration items such as Memory SPD Information, system time and date.

4. Click **Exit (ESC)** or press <Esc> key to close Setup Tree Map screen.
5. Go to My Favorites menu to view the saved BIOS items.

### 3.4 Main menu

The Main menu screen appears when you enter the Advanced Mode of the BIOS Setup program. The Main menu provides you an overview of the basic system information, and allows you to set the system date, time, language, and security settings.

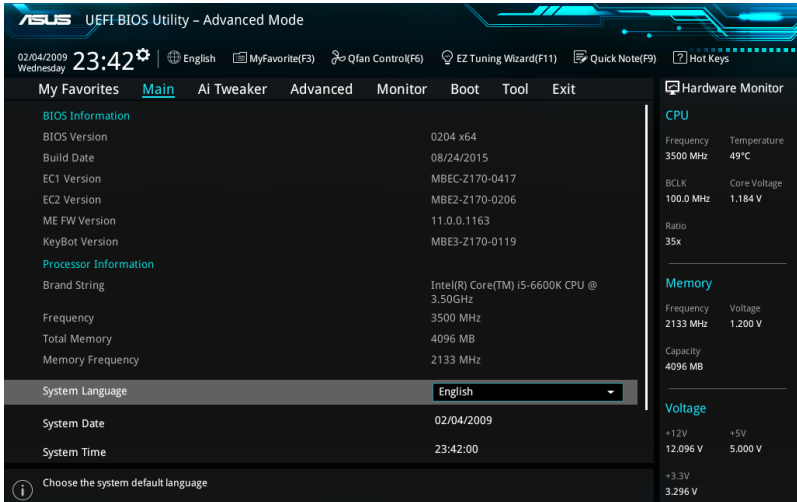

### Security

The Security menu items allow you to change the system security settings.

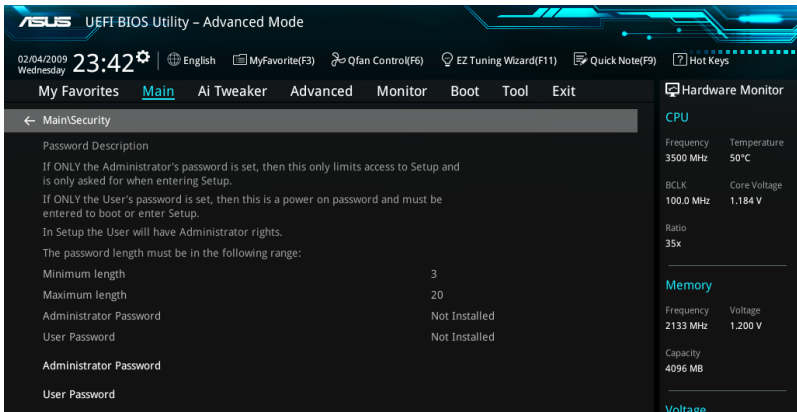

- If you have forgotten your BIOS password, erase the CMOS Real Time Clock (RTC) RAM to clear the BIOS password. See section 1.2.6 Onboard buttons and switches for information on how to erase the RTC RAM via the Clear CMOS button.
- The Administrator or User Password items on top of the screen show the default **[Not Installed]**. After you set a password, these items show **[Installed]**.



## Administrator Password

If you have set an administrator password, we recommend that you enter the administrator password for accessing the system. Otherwise, you might be able to see or change only selected fields in the BIOS setup program.

### To set an administrator password:

1. Select the **Administrator Password** item and press <Enter>.
2. From the **Create New Password** box, key in a password, then press <Enter>.
3. Confirm the password when prompted.

### To change an administrator password:

1. Select the **Administrator Password** item and press <Enter>.
2. From the **Enter Current Password** box, key in the current password, then press <Enter>.
3. From the **Create New Password** box, key in a new password, then press <Enter>.
4. Confirm the password when prompted.

To clear the administrator password, follow the same steps as in changing an administrator password, but press <Enter> when prompted to create/confirm the password. After you clear the password, the **Administrator Password** item on top of the screen shows **[Not Installed]**.

## User Password

If you have set a user password, you must enter the user password for accessing the system. The User Password item on top of the screen shows the default **[Not Installed]**. After you set a password, this item shows **[Installed.]**

### To set a user password:

1. Select the **User Password** item and press <Enter>.
2. From the **Create New Password** box, key in a password, then press <Enter>.
3. Confirm the password when prompted.

### To change a user password:

1. Select the **User Password** item and press <Enter>.
2. From the **Enter Current Password** box, key in the current password, then press <Enter>.
3. From the **Create New Password** box, key in a new password, then press <Enter>.
4. Confirm the password when prompted.

To clear the user password, follow the same steps as in changing a user password, but press <Enter> when prompted to create/confirm the password. After you clear the password, the **User Password** item on top of the screen shows **[Not Installed]**.

### 3.5 Ai Tweaker menu

The Ai Tweaker menu items allow you to configure overclocking-related items.



Be cautious when changing the settings of the Ai Tweaker menu items. Incorrect field values can cause the system to malfunction.



The configuration options for this section vary depending on the CPU and DIMM model you installed on the motherboard.

Scroll down to display other BIOS items.

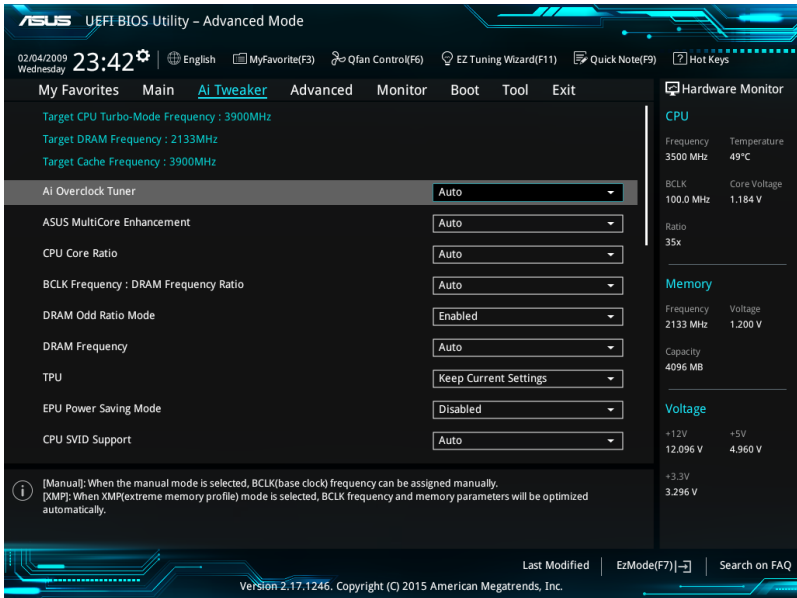

#### Ai Overclock Tuner [Auto]

This item allows you to select the CPU overclocking options to achieve the desired CPU internal frequency. Select any of these preset overclocking configuration options:

- [Auto] Loads the optimal settings for the system.
- [Manual] Automatically optimizes the CPU ratio and BCLK frequency.
- [XMP] If you install memory modules supporting the eXtreme Memory Profile (XMP) Technology, choose this item to set the profiles supported by your memory modules for optimizing the system performance.



---

The following item appears only when you set the Ai Overclocking Tuner to **[Manual]**.

---

### **BCLK Frequency [100.00]**

This item allows you to set the BCLK (base clock) frequency to enhance the system performance. Use the <+> or <-> to adjust the value. The values range from 40.0 MHz to 500.0 MHz.



---

We recommend you to set the value based on the CPU specification, as high BCLK frequencies may damage the CPU permanently.

---

### **ASUS MultiCore Enhancement [Auto]**

[Auto] This item allows you to maximize the overclocking performance optimized by ASUS core ratio settings.

[Disabled] This item allows you to set to default core ratio settings.

### **CPU Core Ratio [Auto]**

This item allows you to set the CPU core ratio limit per core or synchronize automatically to all cores.

Configuration options: [Auto] [Sync All Cores] [Per Core]



---

When the CPU Core Ratio is set to **[Synch All Cores]**, the following item appears:

---

#### **1-Core Ratio Limit [Auto]**

Select **[Auto]** to apply the CPU default Turbo Ratio setting or manually assign a 1-Core Limit value that must be higher than or equal to the 2-Core Ratio Limit.



---

When the CPU Core Ratio is set to **[Per Core]**, the following item appears:

---

#### **1-Core Ratio Limit [Auto]**

Select **[Auto]** to apply the CPU default Turbo Ratio setting or manually assign a 1-Core Limit value that must be higher than or equal to the 2-Core Ratio Limit.

#### **2-Core Ratio Limit [Auto]**

Select **[Auto]** to apply the CPU default Turbo Ratio setting or manually assign a 2-Core Limit value that must be higher than or equal to the 3-Core Ratio Limit.

#### **3-Core Ratio Limit [Auto]**

Select **[Auto]** to apply the CPU default Turbo Ratio setting or manually assign a 3-Core Limit value that must be higher than or equal to the 4-Core Ratio Limit.

**4-Core Ratio Limit [Auto]**

Select **[Auto]** to apply the CPU default Turbo Ratio setting or manually assign a 4-Core Limit value that must be higher than or equal to the 3-Core Ratio Limit.



---

If you assign a value for more Core Ratio Limit, do not set the less Core Ratio Limit to **[Auto]**.

---

**BCLK Frequency : DRAM Frequency Ratio [Auto]**

**[Auto]** The BCLK frequency to DRAM frequency ratio will be set to the optimized setting.

**[100:133]** The BCLK frequency to DRAM frequency ratio will be set to 100:133.

**[100:100]** The BCLK frequency to DRAM frequency ratio will be set to 100:100.

**DRAM Odd Ratio Mode [Enabled]**

This item allows you to enable or disable the odd ratio mode for better granularity.

Configuration options: **[Disabled]** **[Enabled]**

**DRAM Frequency [Auto]**

This item allows you to set the memory operating frequency. The configurable options vary with the BCLK (base clock) frequency setting. Select the auto mode to apply the optimized setting.

Configuration options: **[Auto]** **[DDR4-800MHz]** - **[DDR4-4266MHz]**

**TPU [Keep Current Settings]**

This item allows you to automatically overclock the CPU and DRAM frequencies and voltage for an enhanced system performance.

**[Keep Current Settings]** Keep the current settings without changing anything.

**[TPU I]** Applies air cooling overclocking conditions.

**[TPU II]** Applies water cooling overclocking conditions.



---

Ensure to use water cooling device before selecting **[TPU II]**.

---

**EPU Power Saving Mode [Disabled]**

The ASUS EPU (Energy Processing Unit) sets the CPU in its minimum power consumption settings.

Configuration options: **[Disabled]** **[Enabled]**

**CPU SVID Support**

Disable this item to stop the CPU from communicating with the external voltage regulator.

Configuration options: **[Auto]** **[Disabled]** **[Enabled]**

## DRAM Timing Control

The subitems in this menu allow you to set the DRAM timing control features. Use the <+> or <-> keys to adjust the value. To restore the default setting, type [auto] using the keyboard and press the <Enter> key.



Changing the values in this menu may cause the system to become unstable! If this happens, revert to the default settings.

### Primary Timings

#### **DRAM CAS# Latency [Auto]**

Configuration options: [Auto] [1] – [31]

#### **DRAM RAS# to CAS# Delay [Auto]**

Configuration options: [Auto] [1] – [31]

#### **DRAM RAS# ACT Time [Auto]**

Configuration options: [Auto] [1] – [63]

#### **DRAM COMMAND Rate [Auto]**

Configuration options: [Auto] [1] – [2]

### Secondary Timings

#### **DRAM RAS# to RAS# Delay L [Auto]**

Configuration options: [Auto] [1] – [15]

#### **DRAM RAS# to RAS# Delay S [Auto]**

Configuration options: [Auto] [1] – [15]

#### **DRAM REF Cycle Time [Auto]**

Configuration options: [Auto] [1] – [1023]

#### **DRAM Refresh Interval [Auto]**

Configuration options: [Auto] [1] – [32767]

#### **DRAM WRITE Recovery Time [Auto]**

Configuration options: [Auto] [1] – [31]

#### **DRAM READ to PRE Time [Auto]**

Configuration options: [Auto] [1] – [15]

#### **DRAM FOUR ACT WIN Time [Auto]**

Configuration options: [Auto] [1] – [63]

#### **DRAM WRITE to READ Delay [Auto]**

Configuration options: [Auto] [1] – [15]

#### **DRAM WRITE to READ Delay L [Auto]**

Configuration options: [Auto] [1] – [15]

#### **DRAM WRITE to READ Delay S [Auto]**

Configuration options: [Auto] [1] – [15]

### **DRAM CKE Minimum Pulse Width [Auto]**

Configuration options: [Auto] [1] – [15]

### **DRAM Write Latency [Auto]**

Configuration options: [Auto] [1] – [31]

### **Skew Control**

#### ***ODT RTT WR (CHA) [Auto]***

Configuration options: [Auto] [0 DRAM CLOCK] [80 DRAM CLOCK] [120 DRAM CLOCK] [240 DRAM CLOCK] [255 DRAM CLOCK]

#### ***ODT RTT PARK (CHA) [Auto]***

Configuration options: [Auto] [0 DRAM CLOCK] [34 DRAM CLOCK] [40 DRAM CLOCK] [48 DRAM CLOCK] [60 DRAM CLOCK] [80 DRAM CLOCK] [120 DRAM CLOCK] [240 DRAM CLOCK]

#### ***ODT RTT NOM (CHA) [Auto]***

Configuration options: [Auto] [0 DRAM CLOCK] [34 DRAM CLOCK] [40 DRAM CLOCK] [48 DRAM CLOCK] [60 DRAM CLOCK] [80 DRAM CLOCK] [120 DRAM CLOCK] [240 DRAM CLOCK]

#### ***ODT RTT WR (CHB) [Auto]***

Configuration options: [Auto] [0 DRAM CLOCK] [80 DRAM CLOCK] [120 DRAM CLOCK] [240 DRAM CLOCK] [255 DRAM CLOCK]

#### ***ODT RTT PARK (CHB) [Auto]***

Configuration options: [Auto] [0 DRAM CLOCK] [34 DRAM CLOCK] [40 DRAM CLOCK] [48 DRAM CLOCK] [60 DRAM CLOCK] [80 DRAM CLOCK] [120 DRAM CLOCK] [240 DRAM CLOCK]

#### ***ODT RTT NOM (CHB) [Auto]***

Configuration options: [Auto] [0 DRAM CLOCK] [34 DRAM CLOCK] [40 DRAM CLOCK] [48 DRAM CLOCK] [60 DRAM CLOCK] [80 DRAM CLOCK] [120 DRAM CLOCK] [240 DRAM CLOCK]

#### ***Data Rising Slope [Auto]***

Configuration options: [Auto] [0] - [15]

#### ***Data Rising Slope Offset [Auto]***

Configuration options: [Auto] [0] - [1]

#### ***CMD Rising Slope [Auto]***

Configuration options: [Auto] [0] - [15]

#### ***CMD Rising Slope Offset [Auto]***

Configuration options: [Auto] [0] - [1]

#### ***Ctl Rising Slope [Auto]***

Configuration options: [Auto] [0] - [15]

#### ***Ctl Rising Slope Offset [Auto]***

Configuration options: [Auto] [0] - [1]

#### ***Clk Rising Slope [Auto]***

Configuration options: [Auto] [0] - [15]

#### ***Clk Rising Slope Offset [Auto]***

Configuration options: [Auto] [0] - [1]

#### ***Data Falling Slope [Auto]***

Configuration options: [Auto] [0] - [15]

**Data Falling Slope Offset [Auto]**

Configuration options: [Auto] [0] - [1]

**CMD Falling Slope [Auto]**

Configuration options: [Auto] [0] - [15]

**CMD Falling Slope Offset [Auto]**

Configuration options: [Auto] [0] - [1]

**Ctl Falling Slope [Auto]**

Configuration options: [Auto] [0] - [15]

**Ctl Falling Slope Offset [Auto]**

Configuration options: [Auto] [0] - [1]

**Clk Falling Slope [Auto]**

Configuration options: [Auto] [0] - [15]

**Clk Falling Slope Offset [Auto]**

Configuration options: [Auto] [0] - [1]

**RTL IOL control**

**DRAM RTL INIT Value [Auto]**

Configuration options: [Auto] [0] - [127]

**DRAM RTL (CHA DIMM0 Rank0) [Auto]**

Configuration options: [Auto] [0] - [127]

**DRAM RTL (CHA DIMM0 Rank1) [Auto]**

Configuration options: [Auto] [0] - [127]

**DRAM RTL (CHA DIMM1 Rank0) [Auto]**

Configuration options: [Auto] [0] - [127]

**DRAM RTL (CHA DIMM1 Rank1) [Auto]**

Configuration options: [Auto] [0] - [127]

**DRAM RTL (CHB DIMM0 Rank0) [Auto]**

Configuration options: [Auto] [0] - [127]

**DRAM RTL (CHB DIMM0 Rank1) [Auto]**

Configuration options: [Auto] [0] - [127]

**DRAM RTL (CHB DIMM1 Rank0) [Auto]**

Configuration options: [Auto] [0] - [127]

**DRAM RTL (CHB DIMM1 Rank1) [Auto]**

Configuration options: [Auto] [0] - [127]

**DRAM IOL (CHA DIMM0 Rank0) [Auto]**

Configuration options: [Auto] [0] - [15]

**DRAM IOL (CHA DIMM0 Rank1) [Auto]**

Configuration options: [Auto] [0] - [15]

**DRAM IOL (CHA DIMM1 Rank0) [Auto]**

Configuration options: [Auto] [0] - [15]

**DRAM IOL (CHA DIMM1 Rank1) [Auto]**

Configuration options: [Auto] [0] - [15]

**DRAM IOL (CHB DIMM0 Rank0) [Auto]**

Configuration options: [Auto] [0] - [15]

**DRAM IOL (CHB DIMM0 Rank1) [Auto]**

Configuration options: [Auto] [0] - [15]

**DRAM IOL (CHB DIMM1 Rank0) [Auto]**

Configuration options: [Auto] [0] - [15]

**DRAM IOL (CHB DIMM1 Rank1) [Auto]**

Configuration options: [Auto] [0] - [15]

**IO Latency offset**

**CHA IO\_Latency\_offset**

Configuration options: [Auto] [0] - [127]

**CHB IO\_Latency\_offset**

Configuration options: [Auto] [0] - [127]

**IO Latency RFR delay**

**CHA RFR delay**

Configuration options: [Auto] [0] - [127]

**CHB RFR delay**

Configuration options: [Auto] [0] - [127]

**Third Timings**

**tRDRD\_sg [Auto]**

Configuration options: [Auto] [0] - [63]

**tRDRD\_dg [Auto]**

Configuration options: [Auto] [0] - [63]

**tRDWR\_sg [Auto]**

Configuration options: [Auto] [0] - [63]

**tRDWR\_dg [Auto]**

Configuration options: [Auto] [0] - [63]

**tWRWR\_sg [Auto]**

Configuration options: [Auto] [0] - [63]

**tWRWR\_dg [Auto]**

Configuration options: [Auto] [0] - [63]

**tWRRD\_sg [Auto]**

Configuration options: [Auto] [0] - [127]

**tWRRD\_dg [Auto]**

Configuration options: [Auto] [0] - [63]

**tRDRD\_dr [Auto]**

Configuration options: [Auto] [0] - [63]

**tRDRD\_dd [Auto]**

Configuration options: [Auto] [0] - [63]

**tRDWR\_dr [Auto]**

Configuration options: [Auto] [0] - [63]

**tRDWR\_dd [Auto]**

Configuration options: [Auto] [0] - [63]

**tWRWR\_dr [Auto]**

Configuration options: [Auto] [0] - [63]



**tWRWR\_dd [Auto]**

Configuration options: [Auto] [0] - [63]

**tWRRD\_dr [Auto]**

Configuration options: [Auto] [0] - [63]

**tWRRD\_dd[Auto]**

Configuration options: [Auto] [0] - [63]

**TWRPRE [Auto]**

Configuration options: [Auto] [0] - [127]

**TRDPRE [Auto]**

Configuration options: [Auto] [0] - [15]

**tREFIX9 [Auto]**

Configuration options: [Auto] [0] - [127]

**OREF\_RI[Auto]**

Configuration options: [Auto] [0] - [255]

**Misc.****MRC Fast Boot [Auto]**

Allows you to enable, disable or automatically set the MRC fast boot.

Configuration options: [Auto] [Enabled] [Disabled]

**DRAM CLK Period [Auto]**

Configuration options: [Auto] [1] - [40]

**Memory Scrambler [Enabled]**

Set this item to enable or disable memory scrambler support.

Configuration options: [Enabled] [Disabled]

**Channel A DIMM Control [Enable Both DIMMS]**

Allows you to enable or disable the Channel A DIMM slots.

Configuration options: [Enable Both DIMMS] [Disable DIMM0] [Disable DIMM1] [Disable Both DIMMS]

**Channel B DIMM Control [Enable Both DIMMS]**

Allows you to enable or disable the Channel B DIMM slots.

Configuration options: [Enable Both DIMMS] [Disable DIMM0] [Disable DIMM1] [Disable Both DIMMS]

**MCH Full Check [Auto]**

Enable this item to enhance the stability of your system. Disable this item to enhance the DRAM overclocking capability.

Configuration options: [Auto] [Enabled] [Disabled]

**DLLBwEn [Auto]**

Configuration options: [Auto] [1] - [7]

## External DIGI+ Power Control

### CPU Load-line Calibration [Auto]

Load-line is defined by Intel® specification and affects CPU power voltage. The CPU working voltage decreases proportionally to CPU loading. Higher load-line calibration could get higher voltage and good overclocking performance, but increases the CPU and VRM thermal conditions. Select from levels 1 to 8 to adjust the CPU power voltage from 0% to 100%.

Configuration options [Auto] [Level 1] - [Level 8]



---

The actual performance boost may vary depending on your CPU specification.

---



---

DO NOT remove the thermal module. The thermal conditions should be monitored.

---

### CPU Current Capability [Auto]

This item provides a total power range for CPU overclocking. A higher value setting provides higher power consumption delivery and extends the overclocking frequency range simultaneously.

Configuration options: [Auto] [100%] [110%] [120%] [130%] [140%]



---

Configure higher values when overclocking or under a high CPU loading for extra power support.

---

### CPU VRM Switching Frequency [Auto]

This item affects the VRM transient response speed and the component thermal production. Select [Manual] to configure a higher frequency for a quicker transient response speed.

Configuration options: [Auto] [Manual]



---

DO NOT remove the thermal module. The thermal conditions should be monitored.

---



---

The following item appears only when you set the CPU VRM Switching Frequency to [Manual].

---

#### ***Fixed CPU VRM Switching Frequency (KHz) [500]***

This item allows you to set a higher frequency for a quicker transient response speed. Use the <+> or <-> to adjust the value. The values range from 300 KHz to 600 KHz with an interval of 50 KHz.



---

Do not remove the thermal module when the manual mode is selected. The thermal conditions should be monitored.

---



---

The following item appears only when the CPU VRM Switching Frequency is set to **[Auto]**.

---

### **VRM Spread Spectrum [Auto]**

This item allows to enhance the system stability.

Configuration options: [Auto] [Disabled] [Enabled]

### **CPU Power Duty Control [T.Probe]**

DIGI + VRM Duty Control adjusts the current of every VRM phase and the thermal conditions of every phase component.

[T. Probe]                      Select to set the VRM thermal balance mode.

[Extreme]                      Select to set the VRM current balance mode.



---

DO NOT remove the thermal module. The thermal conditions should be monitored.

---

### **CPU Power Phase Control [Auto]**

This item allows you to set the power phase control of the CPU.

Configuration options: [Auto] [Standard] [Optimized] [Extreme] [Power Phase Response]



---

DO NOT remove the thermal module when setting this item to **[Power Phase Response]**. The thermal conditions should be monitored.

---

### **CPU Power Thermal Control [115]**

Higher temperature provides a wider CPU power thermal range and extends the overclocking tolerance to enlarge the overclocking potential.

Configuration options: [115] - [136]



---

DO NOT remove the thermal module. The thermal conditions should be monitored

---

### **DRAM Current Capability [100%]**

This item provides a total power range for DRAM overclocking. A higher value setting provides higher power consumption delivery and extends the overclocking frequency range simultaneously.

Configuration options: [100%] [110%] [120%] [130%]



---

Configure higher values when overclocking or under a high CPU loading for extra power support.

---

### **DRAM Power Phase Control [Extreme]**

This item allows you to set the power phase control of the DRAM.

Configuration options: [Optimized] [Extreme]

### DRAM Switching Frequency [Auto]

This item affects the VRM transient response speed and the component thermal production. Select **[Manual]** to configure a higher frequency for a quicker transient response speed.

Configuration options: [Auto] [Manual]



DO NOT remove the thermal module. The thermal conditions should be monitored.



The following item appears only when you set the CPU VRM Switching Frequency to **[Manual]**.

#### ***Fixed DRAM Switching Frequency (KHz) [300]***

This item allows you to set a higher frequency for a quicker transient response speed. Use the <+> or <-> to adjust the value. The values range from 300 KHz to 500 KHz with an interval of 50 KHz.



Do not remove the thermal module when the manual mode is selected. The thermal conditions should be monitored.

### Boot Voltages

#### **CPU Core/Cache Boot Voltage [Auto]**

Configuration options: [Auto] [0.600] - [1.700]

#### **DMI Boot Voltage [Auto]**

Configuration options: [Auto] [0.300] - [1.900]

#### **Core PLL Boot Voltage [Auto]**

Configuration options: [Auto] [0.70000] - [2.40000]

#### **CPU System Agent Boot Voltage [Auto]**

Configuration options: [Auto] [0.7000] - [1.8000]

#### **CPU VCCIO Boot Voltage [Auto]**

Configuration options: [Auto] [0.7000] - [1.8000]

### Internal CPU Power Management

The subitems in this menu allow you to set the CPU ratio and features.

#### **Intel(R) SpeedStep(tm) [Auto]**

Allows the operating system to dynamically adjust the processor voltage and cores frequency to decrease the average power consumption and decrease average heat production. Configuration options: [Auto] [Enabled] [Disabled]

#### **Turbo Mode [Enabled]**

Allows you to enable your processor cores to run faster than the base operating frequency when it is below power, current and specification limit. Configuration options: [Disabled] [Enabled]



---

The following items appear only when you set the Turbo Mode to **[Enabled]**.

---

#### **Turbo Mode Parameters**

##### **Long Duration Package Power Limit [Auto]**

Allows you to limit the Turbo Ratio's time duration that exceeds the TDP (Thermal Design Power) for maximum performance. Use the <+> and <-> keys to adjust the value.

Configuration options: [Auto] [1] - [4095]

##### **Package Power Time Window [Auto]**

Also known as Power Limit 1, and allows you to maintain the time window for Turbo Ratio over TDP (Thermal Design Power). Use the <+> and <-> keys to adjust the value.

Configuration options: [Auto] [1] - [127]

##### **Short Duration Package Power Limit [Auto]**

Also known as Power Limit 2, and allows you to provide rapid protection when the package power exceeds the Power Limit 1. Use the <+> and <-> keys to adjust the value.

Configuration options: [Auto] [1] - [4095]

#### **IA AC Load Line [Auto]**

This item allows you to set the AC loadline defined in 1/100 mOhms. Use the <+> and <-> keys to adjust the value.

Configuration options: [Auto] [0.01] - [62.49]

#### **IA DC Load Line [Auto]**

This item allows you to set the DC loadline defined in 1/100 mOhms. Use the <+> and <-> keys to adjust the value.

Configuration options: [Auto] [0.01] - [62.49]

### **Tweaker's Paradise**

#### **FCLK Frequency for Early Power On [Auto]**

This item allows you to set the FCLK Frequency for Early Power On.

Configuration options: [Auto] [Normal (800 MHz)] [1GHz] [400 MHz]

#### **Initial BCLK Frequency [Auto]**

This item allows you to start overclocking the system from the initial BCLK (base clock) frequency to the assigned BCLK frequency. Use the <+> or <-> to adjust the value.

The values range from 40.0 MHz to 500.0 MHz.

#### **BCLK Amplitude [Auto]**

This item allows you to set the magnitude of the base clock driven for the processor.

Configuration options: [Auto] [700mV] [800mV] [900mV] [1000mV]

#### **BCLK Slew Rate [Auto]**

This item allows you to set the speed at which each clock rises and falls.

Configuration options: [Auto] [1.5V/ns] [2.5V/ns] [3.5V/ns] [4.5V/ns]

**BCLK Spread Spectrum [Auto]**

This item allows you to reduce the EMI. Disable to get more accurate base clocks.

Configuration options: [Auto] [Disabled] [-0.22] [-0.34] [-0.46] [+0.12] [+0.22] [+0.28] [+0.38] [+0.17]

**BCLK Frequency Slew Rate [Auto]**

Configuration options: [Auto] [Disabled] [32us/MHz] [64us/MHz] [128us/MHz] [512us/MHz]

**DRAM VTT Voltage [Auto]**

Configuration options: [Auto] [0.500] - [1.300]

**VPPDDR Voltage [Auto]**

Configuration options: [Auto] [1.86500] - [3.13500]

**DMI Voltage [Auto]**

Configuration options: [Auto] [0.30000] - [1.90000]

**Core PLL Voltage [Auto]**

Configuration options: [Auto] [0.70000] - [2.40000]

**Internal PLL Voltage [Auto]**

Configuration options: [Auto] [0.9000] - [1.845]

**PLL Bandwidth [Auto]**

Configuration options: [Auto] [Level 0] - [Level 10]

**CPU Core/Cache Current Limit Max. [Auto]**

This item allows you to configure a higher current limit to prevent a frequency or power throttling when overclocking. Use the <+> and <-> keys to adjust the value.

Configuration options: [Auto] [0.00] - [255.50]

**Min. CPU Cache Ratio [Auto]**

This item allows you to set the minimum possible CPU cache ratio. Use the <+> and <-> keys to adjust the value.

Configuration options: [Auto] [8] - [26]

**Max. CPU Cache Ratio [Auto]**

This item allows you to set the maximum possible CPU cache ratio. Use the <+> and <-> keys to adjust the value.

Configuration options: [Auto] [8] - [26]

**Extreme Over-voltage [Disabled]**

Enable this item to allow higher voltages for overclocking, but the CPU lifetime will not be guaranteed

Configuration options: [Disabled] [Enabled]



---

This item can only be enabled when the onboard CPU\_OV jumper is switched on.

---

## CPU Core/Cache Voltage [Auto]

Configures the mode of Voltage fed to the cores of the processor.

Configuration options: [Auto] [Manual Mode] [Offset Mode] [Adaptive Mode]



---

The following items appear only when you set the CPU Core/Cache Voltage to **[Manual Mode]**.

---

### CPU Core Voltage Override [Auto]

Allows you to configure the CPU Core voltage.

Configuration options: [Auto] [0.600] - [1.700]



---

The following items appear only when you set the CPU Core/Cache Voltage to **[Offset Mode]**.

---

### Offset Mode Sign [+]

[+] To offset the voltage by a positive value.

[-] To offset the voltage by a negative value.

### CPU Core Voltage Offset [Auto]

This item allows you to configure the CPU core voltage offset value.

Configuration options: [Auto] [0.005] - [0.635]



---

The following items appear only when you set the CPU Core/Cache Voltage to **[Adaptive Mode]**.

---

### Offset Mode Sign [-]

[+] To offset the voltage by a positive value.

[-] To offset the voltage by a negative value.

### Additional Turbo Mode CPU Core Voltage [0.250]

This item allows you to configure the CPU core voltage offset value.

Configuration options: [0.250] - [1.920]

### Offset Voltage [Auto]

This item allows you to configure the CPU core voltage offset value.

Configuration options: [Auto] [0.001] - [0.999]

## DRAM Voltage [Auto]

Configuration options: [Auto] [1.0000] - [2.0000]

## CPU VCCIO Voltage [Auto]

Configuration options: [Auto] [0.70000] - [1.80000]

## CPU System Agent Voltage [Auto]

Configuration options: [Auto] [0.70000] - [1.80000]

## PLL Termination Voltage [Auto]

Configuration options: [Auto] [0.36000] - [2.10000]

## **PCH Core Voltage [Auto]**

Configuration options: [Auto] [0.70000] - [1.80000]

## **CPU Standby Voltage [Auto]**

Configuration options: [Auto] [0.80000] - [1.80000]

## **DRAM REF Voltage Control**

### **DRAM CTRL REF Voltage on CHA/CHB [Auto]**

Configures the DRAM reference voltage on the control lines. The reference voltage will be the DRAM voltage times the configured value.

Configuration options: [Auto] [0.39500] - [0.63000]

### **DRAM DATA REF Voltage on CHA DIMM0 Rank0 BL0-7 [Auto]**

Configures the DRAM Data REF Voltage.

Configuration options: [Auto] [0] - [63]

### **DRAM DATA REF Voltage on CHA DIMM0 Rank1 BL0-7 [Auto]**

Configures the DRAM Data REF Voltage.

Configuration options: [Auto] [0] - [63]

### **DRAM DATA REF Voltage on CHA DIMM1 Rank0 BL0-7 [Auto]**

Configures the DRAM Data REF Voltage.

Configuration options: [Auto] [0] - [63]

### **DRAM DATA REF Voltage on CHA DIMM1 Rank1 BL0-7 [Auto]**

Configures the DRAM Data REF Voltage.

Configuration options: [Auto] [0] - [63]

### **DRAM DATA REF Voltage on CHB DIMM0 Rank0 BL0-7 [Auto]**

Configures the DRAM Data REF Voltage.

Configuration options: [Auto] [0] - [63]

### **DRAM DATA REF Voltage on CHB DIMM0 Rank1 BL0-7 [Auto]**

Configures the DRAM Data REF Voltage.

Configuration options: [Auto] [0] - [63]

### **DRAM DATA REF Voltage on CHB DIMM1 Rank0 BL0-7 [Auto]**

Configures the DRAM Data REF Voltage.

Configuration options: [Auto] [0] - [63]

### **DRAM DATA REF Voltage on CHB DIMM1 Rank1 BL0-7 [Auto]**

Configures the DRAM Data REF Voltage.

Configuration options: [Auto] [0] - [63]



## 3.6 Advanced menu

The Advanced menu items allow you to change the settings for the CPU and other system devices.



Be cautious when changing the settings of the Advanced menu items. Incorrect field values can cause the system to malfunction.

ASUS UEFI BIOS Utility - Advanced Mode

02/04/2009 Wednesday 23:43 English MyFavorite(F3) Qfan Control(F6) EZ Tuning Wizard(F11) Quick Note(F9) Hot Keys

My Favorites Main AI Tweaker **Advanced** Monitor Boot Tool Exit

- > CPU Configuration
- > Platform Misc Configuration
- > System Agent (SA) Configuration
- > PCH Configuration
- > PCH Storage Configuration
- > USB Configuration
- > Network Stack Configuration
- > Onboard Devices Configuration
- > APM Configuration
- > HDD/SSD SMART Information
- > Intel(R) Thunderbolt Configuration

Hardware Monitor

**CPU**

Frequency	Temperature
3500 MHz	49°C

BCLK Core Voltage

100.0 MHz	1.184 V
-----------	---------

Ratio

35x

**Memory**

Frequency	Voltage
2133 MHz	1.200 V

Capacity

4096 MB

**Voltage**

+12V	+5V
12.096 V	5.000 V
+3.3V	
3.296 V	

CPUs Configuration Parameters

Last Modified | EZMode(F7) [-] | Search on FAQ

Version 2.17.1246. Copyright (C) 2015 American Megatrends, Inc.

### 3.6.1 CPU Configuration

The items in this menu show the CPU-related information that the BIOS automatically detects.



The items in this menu may vary based on the CPU installed.

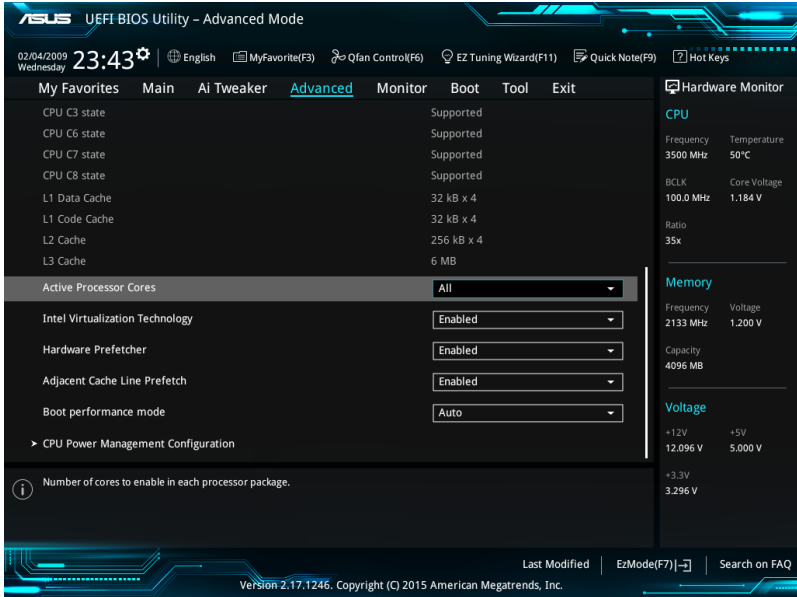

#### Hyper-threading [Enabled]

This item allows a hyper-threading processor to appear as two logical processors, allowing the operating system to schedule two threads or processors simultaneously.

Configuration options: [Disabled] [Enabled]

#### Active Processor Cores [All]

This item allows you to select the number of CPU cores to activate in each processor package.

Configuration options: [All] [1] [2] [3]

#### Intel Virtualization Technology [Disabled]

When set to [Enabled], a VMM can utilize the additional hardware capabilities provided by Vanderpool Technology.

Configuration options: [Disabled] [Enabled]

**Hardware Prefetcher [Enabled]**

This item allows the CPU to prefetch commands and data in the L2 cache, reduces the DRAM loading time and improves the system performance.

Configuration options: [Disabled] [Enabled]

**Adjacent Cache Line Prefetcher [Enabled]**

This item allows the mid level cache (L2) to prefetch adjacent cache lines, reducing the DRAM loading time and improves the system performance.

Configuration options: [Disabled] [Enabled]

**Boot Performance Mode [Auto]**

This item allows you to select the CPU performance state during system boot before the operating system takes control. The CPU runs at a selected performance ratio based on CPU configuration.

Configuration options: [Auto] [Max Non-Turbo Performance] [Max Battery] [Turbo Performance]

**CPU Power Management Configuration**

This item allows you to manage and configure the CPU's power.

**Intel(R) SpeedStep(tm) [Auto]**

This item allows more than two frequency to be supported.

Configuration options: [Auto] [Enabled] [Disabled]

**Turbo Mode [Enabled]**

This item allows you to automatically set the CPU cores to run faster than the base operating frequency when it is below the operating power, current and temperature specification limit.

Configuration options: [Enabled] [Disabled]

**CPU C-States [Auto]**

This item allows you to set the power saving of the CPU states.

Configuration options: [Auto] [Disabled] [Enabled]



---

The following items appear only when you set the CPU C-States to **[Enabled]**.

---

**Enhanced C-States [Enabled]**

When enabled, CPU will switch to minimum speed when all cores enter C-State.

Configuration options: [Enabled] [Disabled]

**CPU C3 Report [Enabled]**

This item allows you to disable or enable the CPU C3 report to the operating system.

Configuration options: [Enabled] [Disabled]

**CPU C6 Report [Enabled]**

This item allows you to disable or enable the CPU C6 report to the operating system.

Configuration options: [Enabled] [Disabled]

**CPU C7 Report [CPU C7s]**

This item allows you to disable or enable the CPU C7 report to the operating system.

Configuration options: [CPU C7] [CPU C7s] [Disabled]

**CPU C8 Report [Enabled]**

This item allows you to disable or enable the CPU C8 report to the operating system.

Configuration options: [Enabled] [Disabled]

**Package C State Limit [Auto]**

This item allows you to set the a C-state limit for the CPU package.

Configuration options: [Auto] [C0/C1] [C2] [C3] [C6] [C7] [C7s] [C8]

**CFG Lock [Enabled]**

This item allows you to disable or enable the CFG Lock.

Configuration options: [Enabled] [Disabled]

## 3.6.2 Platform Misc Configuration

The items in this menu allow you to configure the platform-related features.

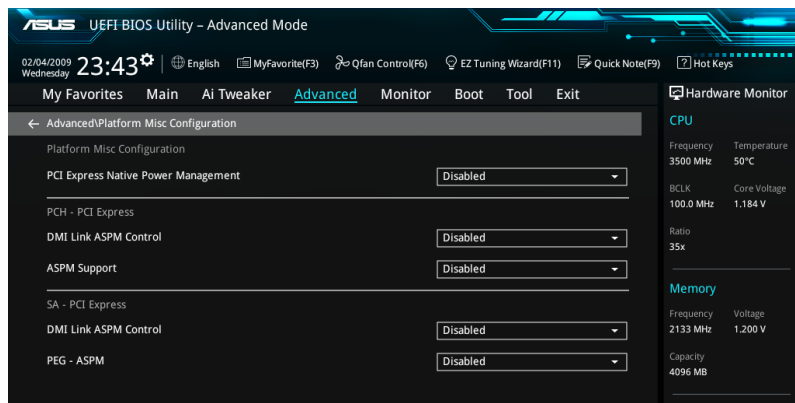

## PCIe Native Power Management [Disabled]

This item allows you to enhance the power saving feature of PCI Express and perform ASPM operations in the operating system.

Configuration options: [Disabled] [Enabled]



---

The following item appears only when you set the PCI Express Native Power Management to [Enabled].

---

### Native ASPM [Disabled]

[Enabled] Windows® Vista OS controls the ASPM (active state power management) support for devices.

[Disabled] BIOS controls the ASPM support for the device.

## PCH - PCI Express

### DMI Link ASPM Control [Disabled]

This item allows you to control the Active State Power Management on both NB (NorthBridge) side and SB (SouthBridge) side of the DMI Link.

Configuration options: [Disabled] [Enabled]

### ASPM Support [Disabled]

This item allows you to select the ASPM state for energy-saving conditions.

Configuration options: [Disabled] [L0s] [L1] [L0sL1] [Auto]

## SA - PCI Express

### DMI Link ASPM Control [Disabled]

This item allows you to control the Active State Power Management on both CPU and PCH (platform controller hub) Both DMI link ASPM control items of the CPU and PCH sides must be enabled for the ASPM to take effect.

Configuration options: [Disabled] [L1]

### PEG ASPM Support [Disabled]

This item allows you to select the ASPM state for energy-saving conditions, or use the ASUS optimized energy saving profile.

Configuration options: [Disabled] [Auto] [ASPM L0s] [ASPM L1] [ASPM L0sL1]

### 3.6.3 System Agent (SA) Configuration

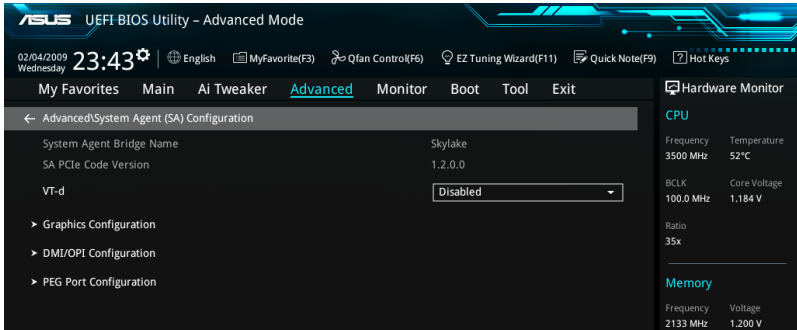

#### VT-d [Enabled]

Allows you to enable virtualization technology function on memory control hub.

Configuration options: [Enabled] [Disabled]

#### Graphics Configuration

This item allows you to select a primary display from CPU and PCIe graphical devices.

##### Primary Display [Auto]

This item allows you to select the primary display from CPU and PCIe devices.

Configuration options: [Auto] [IGFX] [PEG] [PCIe]

##### iGPU Multi-Monitor [Disabled]

This item allows you to enable the iGPU Multi-Monitor. The iGPU shared system memory size is fixed 64 MB.

Configuration options: [Disabled] [Enabled]

#### DMI/OPI Configuration

This item allows you to control various DMI (direct media interface) functions.

##### DMI Max Link Speed [Auto]

Set this item to [Enabled] to set DMI speed.

Configuration options: [Auto] [Gen1] [Gen2] [Gen3]

#### PEG Port Configuration

This item allows you to configure the PEG Port settings.

##### PCIEx16\_1 Link Speed [Auto]

This item allows you to configure the PCIEx16\_1 slot.

Configuration options: [Auto] [Gen1] [Gen2] [Gen3]

##### PCIEx16\_2 Link Speed [Auto]

This item allows you to configure the PCIEx16\_2 slot.

Configuration options: [Auto] [Gen1] [Gen2] [Gen3]

## 3.6.4 PCH Configuration

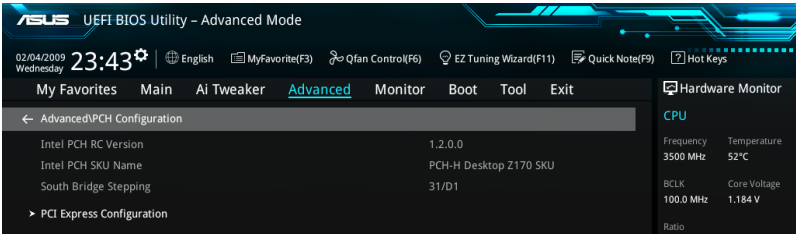

### PCI Express Configuration

This item allows you to configure the PCI Express slots.

#### PCIe Speed [Auto]

This item allows your system to automatically select the PCI Express port speed.

Configuration options: [Auto] [Gen1] [Gen2] [Gen3]

### 3.6.5 PCH Storage Configuration

While entering Setup, the BIOS automatically detects the presence of SATA devices. The SATA Port items show **Not Present** if no SATA device is installed to the corresponding SATA port.

Scroll down to display the other BIOS items.

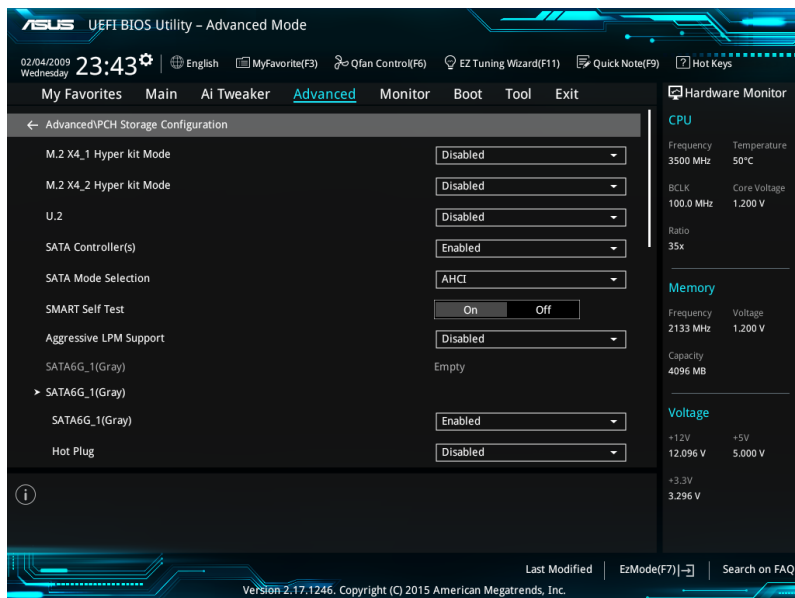

#### **M.2 X4\_1 Hyper kit Mode [Disabled]**

Disable this option for M.2 devices. Enable this option for “ASUS Hyper kit” card.

Configuration options: [Disabled] [Enabled]

#### **M.2 X4\_2 Hyper kit Mode [Disabled]**

Disable this option for M.2 devices. Enable this option for “ASUS Hyper kit” card.

Configuration options: [Disabled] [Enabled]

#### **U.2 [Disabled]**

This item allows you to enable or disable the U.2.

Configuration options: [Disabled] [Enabled]

#### **SATA Controller(s) [Enabled]**

This item allows you to enable or disable the SATA Device.

Configuration options: [Disabled] [Enabled]



## SATA Mode Selection [AHCI]

This item allows you to set the SATA configuration.

- [AHCI] Set to [AHCI] when you want the SATA hard disk drives to use the AHCI (Advanced Host Controller Interface). The AHCI allows the onboard storage driver to enable advanced Serial ATA features that increases storage performance on random workloads by allowing the drive to internally optimize the order of commands.
- [RAID] Set to [RAID] when you want to create a RAID configuration from the SATA hard disk drives.



---

The following item appears only when you set the SATA Mode Selection to [RAID].

---

### M.2 X4\_1 PCIE Storage RAID Support [Disabled]

Enable this item to remap PCIE port to SATA for RAID support.

Configuration options: [Disabled] [Enabled]

### M.2 X4\_2 PCIE Storage RAID Support [Disabled]

Enable this item to remap PCIE port to SATA for RAID support.

Configuration options: [Disabled] [Enabled]

## SMART Self Test [On]

SMART (Self-Monitoring, Analysis and Reporting Technology) is a monitoring system that shows a warning message during POST (Power-on Self Test) when an error occurs in the hard disks.

Configuration options: [On] [Off]

## Aggressive LPM Support [Disabled]

This item is designed for LPM (link power management) support with a better energy saving conditions. When disabled, the hot plug function of SATA ports are disabled.

Configuration options: [Disabled] [Enabled]

## SATA6G\_1(Gray) - SATA6G\_6(Gray)

### SATA6G\_1(Gray) - SATA6G\_6(Gray) [Enabled]

This item allows you to enable or disable the selected SATA port.

Configuration options: [Disabled] [Enabled]

### Hot Plug [Disabled]

These items appears only when the SATA Mode Selection is set to [AHCI] and allows you to enable or disable SATA Hot Plug Support.

Configuration options: [Disabled] [Enabled]

## 3.6.6 USB Configuration

The items in this menu allow you to change the USB-related features.

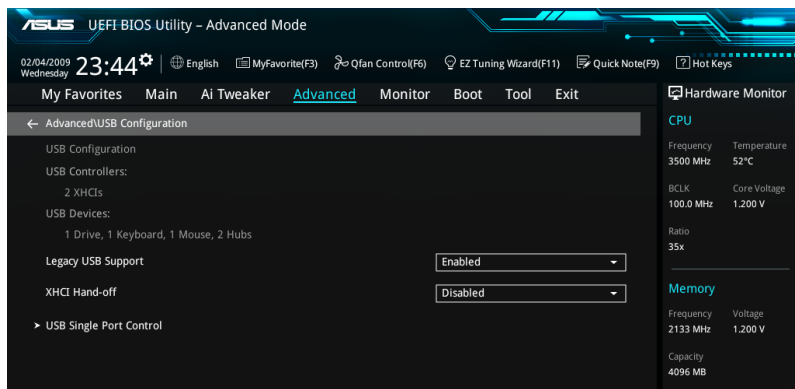

The **Mass Storage Devices** item shows the auto-detected values. If no USB device is detected, the item shows **None**.

### Legacy USB Support [Enabled]

- [Enabled] Your system supports the USB devices in legacy operating systems.
- [Disabled] Your USB devices can be used for BIOS setup only and cannot be recognized in the boot devices list.
- [Auto] Your system automatically detects the presence of USB devices at startup. If any USB devices are detected, the legacy USB support is enabled.

### XHCI Hand-off [Disabled]

- [Enabled] Enables the support for operating systems without an XHCI hand-off feature.
- [Disabled] Disables the XHCI Hand-off support.

### USB Single Port Control

This item allows you to enable or disable the individual USB ports.



Refer to section **1.2.2 Motherboard layout** for the location of the USB ports.

### 3.6.7 Network Stack Configuration

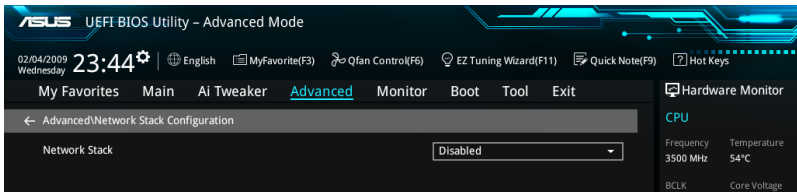

#### Network stack [Disable]

This item allows you to disable or enable the UEFI network stack.

Configuration options: [Disable] [Enable]



The following item appears only when you set the Network Stack to [Enabled].

#### Ipv4/Ipv6 PXE Support [Enabled]

This item allows you to enable or disable the Ipv4/Ipv6 PXE wake event.

Configuration options: [Disabled] [Enabled]

### 3.6.8 Onboard Devices Configuration

Scroll down to view the other BIOS items.

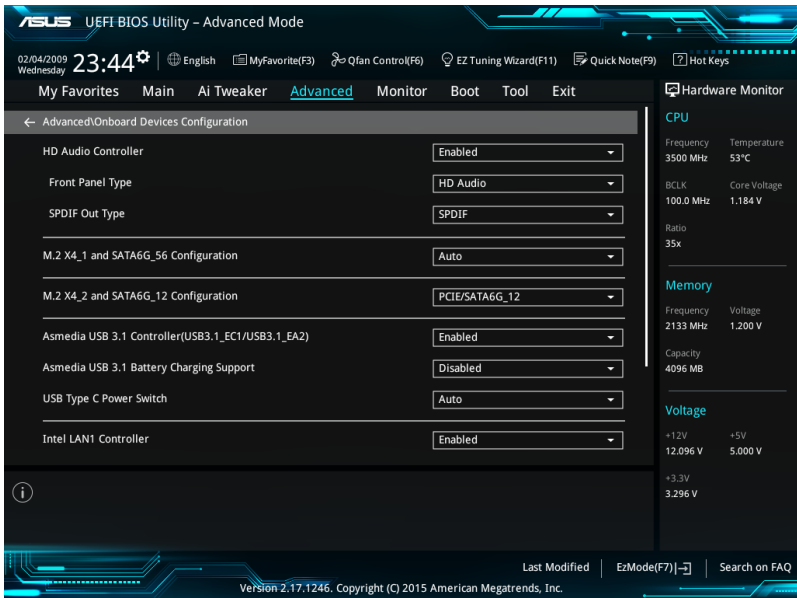

## HD Audio Controller [Enabled]

This item allows you to use the Azalia High Definition Audio Controller

Configuration options: [Disabled] [Enabled]



---

The following items appear only when you set the HD Audio Controller to **[Enabled]**.

---

### Front Panel Type [HD Audio]

This item allows you to set the front panel audio connector (AAFP) mode to legacy AC'97 or high-definition audio depending on the audio standard that the front panel audio module supports.

[HD Audio] Sets the front panel audio connector (AAFP) mode to high definition audio.

[AC97] Sets the front panel audio connector (AAFP) mode to legacy AC'97

### SPDIF Out Type [SPDIF]

[SPDIF] Sets to an SPDIF audio output.

[HDMI] Sets to an HDMI audio output.

## M.2 X4\_1 and SATA6G\_56 Configuration [Auto]

This item allows you to set the SATA6G\_56 Configuration.

Configuration options: [Auto] [SATA6G\_56]

## M.2 X4\_2 and SATA6G\_12 Configuration [PCIe/SATA6G\_12]

This item allows you to set the SATA6G\_12 Configuration.

Configuration options: [PCIe/SATA6G\_12] [M.2 SATA]

## ASMedia USB 3.1 Controller(USB3.1\_EC1/USB3.1EA2) [Enabled]

This item allows you to disable or enable the ASMedia® USB 3.1 controller of your system.

Configuration options: [Disabled] [Enabled]

## ASMedia USB 3.1 Battery Charging Support [Disabled]

This item allows you to disable or enable the ASMedia USB 3.1 battery charging support of your system.

Configuration options: [Disabled] [Enabled]

## USB Type C Power Switch [Auto]

[Auto] The system will automatically detect your USB Type C devices and provide suitable power if needed.

[Enabled] The USB Type C port will always provide power to your devices.

### Intel LAN Controller (LAN1-LAN2) [Enabled]

This item allows you to enable or disable the Intel LAN1/2 controllers.

Configuration options: [Disabled] [Enabled]



---

The following item appears only when you set the Intel LAN Controller to **[Enabled]**.

---

#### Intel PXE Option ROM (LAN1-LAN2) [Disabled]

This item allows you to enable or disable the PXE OptionRom of the Intel® LAN controller.

Configuration options: [Enabled] [Disabled]

### Serial Port Configuration

#### Serial Port [On]

This item allows you to enable or disable the Serial Port.

Configuration options: [On] [Off]

#### Change Settings [IO=3F8h; IRQ=4]

This item allows you to select an optimal setting for Super IO device.

Configuration options: [IO=3F8h; IRQ=4] [IO=2F8h; IRQ=3] [IO=3E8h; IRQ=4]  
[IO=2E8h; IRQ=3]

## 3.6.9 APM Configuration

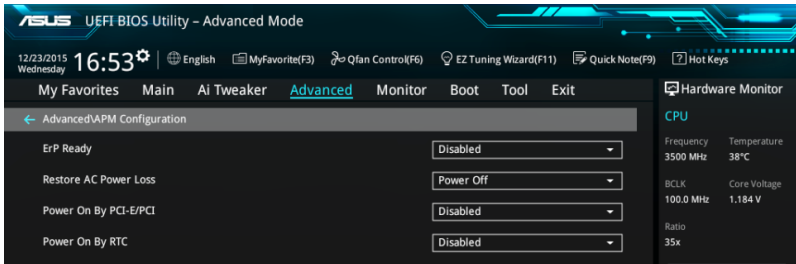

### ErP Ready [Disabled]

This item allows you to switch off some power at S4+S5 or S5 to get the system ready for ErP requirement. When set to **[Enabled]**, all other PME options are switched off.

Configuration options: [Disabled] [Enabled (S4+S5)] [Enabled (S5)]

### Restore AC Power Loss [Power Off]

This item allows your system to go to ON state, OFF state, or both states after an AC power loss. When setting your system to [Last State], it goes to the previous state before the AC power loss.

Configuration options: [Power Off] [Power On] [Last State]

### Power On By PCI-E/PCI [Disabled]

This item allows you to enable or disable the Wake-on-LAN function of the onboard LAN controller or other installed PCI-E LAN cards.

Configuration options: [Disabled] [Enabled]

### Power On By RTC [Disabled]

This item allows you to enable or disable the RTC (Real-Time Clock) to generate a wake event and configure the RTC alarm date. When enabled, you can set the days, hours, minutes, or seconds to schedule an RTC alarm date.

Configuration options: [Disabled] [Enabled]

### 3.6.10 HDD/SSD SMART Information

This menu displays the SMART information of the connected devices.

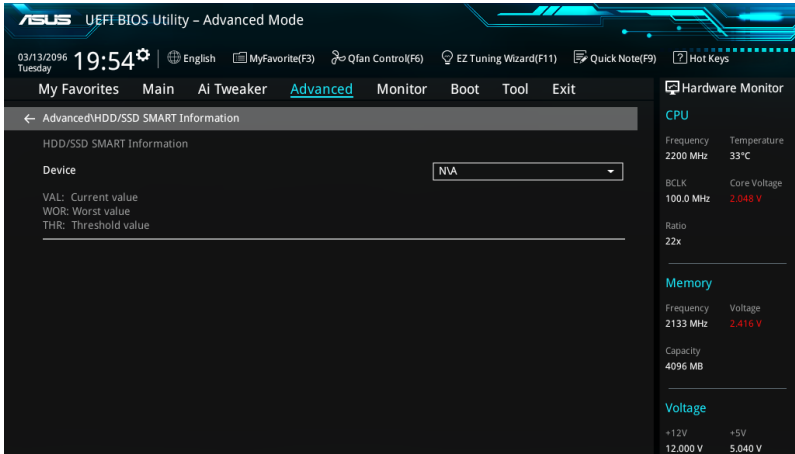

### 3.6.11 Intel(R) Thunderbolt Configuration

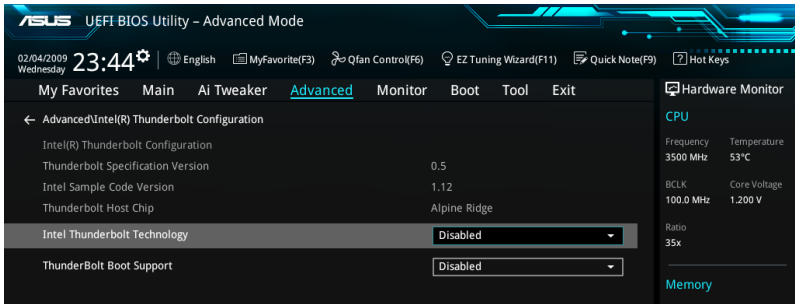

#### Intel Thunderbolt Technology [Disabled]

This item allows you to disable or enable the Intel Thunderbolt Technology.

Configuration options: [Fully Disabled] [Disabled] [Enabled]

#### Thunderbolt Boot Support [Enabled]

This item allows you to disable or enable the Thunderbolt Boot Support.

Configuration options: [Disabled] [Enabled]

## 3.7 Monitor menu

The Monitor menu displays the system temperature/power status, and allows you to change the fan settings.

Scroll down to display the other BIOS items.

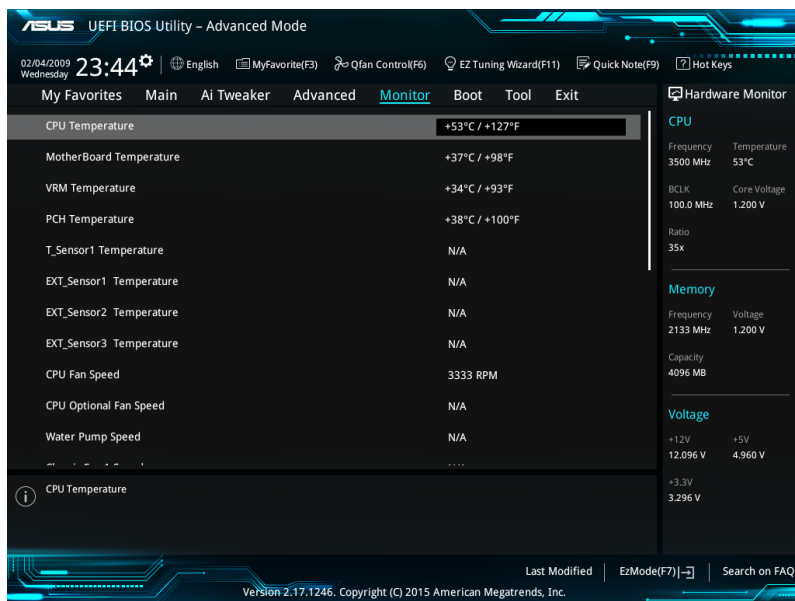

### CPU Temperature / Motherboard Temperature / VRM Temperature / PCH Core Temperature / T\_SENSOR1 Temperature / EXT\_SENSOR1-3 Temperature [xxx°C/xxx°F]

The onboard hardware monitor automatically detects and displays the CPU, motherboard, VRM, PCH Core, and SENSOR1 temperatures. Select **[Ignore]** if you do not wish to display the detected temperatures.

### CPU Fan Speed, CPU Optional Fan, Water Pump Speed, Chassis Fan 1-4 Speed, EXT Fan 1-3 [xxxx RPM] or [Ignore] / [N/A]

The onboard hardware monitor automatically detects and displays the CPU, chassis, and power fan speed in rotations per minute (RPM). If the fan is not connected to the motherboard, the field shows N/A. Select **[Ignore]** if you do not wish to display the detected speed.

### CPU Core Voltage, 3.3V Voltage, 5V Voltage, 12V Voltage

The onboard hardware monitor automatically detects the voltage output through the onboard voltage regulators. Select **[Ignore]** if you do not want to detect this item.



## Qfan Configuration

### Qfan Tuning

Click this item to automatically detect the lowest speed and configure the minimum duty cycle for each fan.

#### CPU Q-Fan Control [Auto]

- [Auto] Detect the type of CPU fan installed and automatically switches the mode control.
- [PWM Mode] Enable the CPU Q-Fan control feature in PWM mode for 4-pin CPU fan.
- [DC Mode] Enable the CPU Q-Fan control feature in DC mode for 3-pin CPU fan.
- [Disabled] Disable the Q-Fan control.

#### CPU Fan Step Up [0 sec]

This item allows you to set the value of the CPU fan step up.

Configuration options: [0 sec] [2.1 sec] [2.8 sec] [3.6 sec] [4.5 sec] [5.0 sec] [6.3 sec] [8.5 sec] [12 sec] [25 sec]

#### CPU Fan Step Down [0 sec]

This item allows you to set the value of the CPU fan step down.

Configuration options: [0 sec] [2.1 sec] [2.8 sec] [3.6 sec] [4.5 sec] [5.0 sec] [6.3 sec] [8.5 sec] [12 sec] [25 sec]

#### CPU Fan Speed Lower Limit [200 RPM]

This item allows you to set the low limit warning for CPU Fan speed.

Configuration options: [Ignore] [200 RPM] [300 RPM] [400 RPM] [500 RPM] [600 RPM]

#### CPU Fan Profile [Standard]

This item allows you to set the appropriate performance level of the CPU fan.

- [Standard] Set to make the CPU fan adjust automatically depending on the CPU temperature.
- [Silent] Set to minimize the fan speed for quiet CPU fan operation.
- [Turbo] Set to achieve maximum CPU fan speed.
- [Manual] Set to assign the detailed fan speed control parameters.



---

The following items appear only when you set the CPU Fan Profile to **[Manual]**.

---

#### **CPU Upper Temperature [70]**

Use the <+> or <-> keys to adjust the upper limit of the CPU temperature. The values range from 25 to 75.

#### **CPU Fan Max. Duty Cycle (%) [100]**

Use the <+> or <-> keys to adjust the maximum CPU fan duty cycle. The values range from 20% to 100%. When the CPU temperature reaches the upper limit, the CPU fan will operate at the maximum duty cycle.

#### **CPU Middle Temperature [25]**

Use the <+> or <-> keys to adjust the middle limit of the CPU temperature. The values range from 20 to 75.

**CPU Fan Middle. Duty Cycle (%) [20]**

Use the <+> or <-> keys to adjust the maximum CPU fan duty cycle. The values range from 20% to 100%. When the CPU temperature reaches the upper limit, the CPU fan will operate at the maximum duty cycle.

**CPU Lower Temperature [20]**

Use the <+> or <-> keys to adjust the lower limit of the CPU temperature. The values range from 20 to 75. The CPU fan will operate at the minimum duty cycle when the temperature is lower than the limit.

**CPU Fan Min. Duty Cycle(%) [20]**

Use the <+> or <-> keys to adjust the minimum CPU fan duty cycle. The values range from 0% to 100%. When the CPU temperature is under the limit, the CPU fan will operate at the minimum duty cycle.

**Chassis Fan 1-4 Q-Fan Control [DC Mode]**

- [Disabled]      Disable the Chassis Q-Fan control feature.  
 [DC mode]      Enable the Chassis Q-Fan control in DC mode for 3-pin chassis fan.  
 [PWM mode]    Enable the Chassis Q-Fan control in PWM mode for 4-pin chassis fan.

**Chassis Fan 1-4 Q-Fan Source [CPU]**

The assignment fan will be controlled according to the selected temperature source.  
 Configuration options: [CPU] [MotherBoard] [VRM] [PCH] [T\_SENSOR1] [EXT\_Sensor1] [EXT\_Sensor2] [EXT\_Sensor3]



---

For EXT\_Sensor1-3, connect a Thermistor cable to the EXT\_TS1-3 header then place the other end to the component to get the temperature.

---

**Chassis Fan 1-4 Step Up [0 sec]**

This item allows you to set the value of the CPU fan step up.  
 Configuration options: [0 sec] [12 sec] [25 sec] [51 sec] [76 sec] [102 sec] [127 sec] [153 sec] [178 sec] [204 sec]

**Chassis Fan 1-4 Step Down [0 sec]**

This item allows you to set the value of the CPU fan step down.  
 Configuration options: [0 sec] [12 sec] [25 sec] [51 sec] [76 sec] [102 sec] [127 sec] [153 sec] [178 sec] [204 sec]

**Chassis Fan 1-4 Fan Speed Low Limit [200 RPM]**

This item allows you to disable or set the chassis fan warning speed.  
 Configuration options: [Ignore] [200 RPM] [300 RPM] [400 RPM] [500 RPM] [600 RPM]

**Chassis Fan 1-4 Profile [Standard]**

- This item allows you to set the appropriate performance level of the chassis fan.
- [Standard]      Sets to [Standard] to make the chassis fan automatically adjust depending on the chassis temperature.
- [Silent]        Sets to [Silent] to minimize the fan speed for quiet chassis fan operation.
- [Turbo]         Sets to [Turbo] to achieve maximum chassis fan speed.
- [Manual]        Sets to [Manual] to assign detailed fan speed control parameters.



---

The following four items appear only when you set Chassis Fan 1-4 Profile to **[Manual]**.

---

**Chassis Fan 1-4 Upper Temperature [70]**

Use the <+> or <-> keys to adjust the upper limit of the Chassis Fan 1-4 temperature. The values range from 20 to 75.

**Chassis Fan 1-4 Max. Duty Cycle (%) [100]**

Use the <+> or <-> keys to adjust the maximum Chassis Fan 1-4 duty cycle. The values range from 20% to 100%. When the CPU temperature reaches the upper limit, the Chassis Fan 1-4 will operate at the maximum duty cycle.

**Chassis Fan 1-4 Middle Temperature [45]**

Use the <+> or <-> keys to adjust the middle limit of the Chassis Fan 1-4 temperature. The values range from 20 to 75.

**Chassis Fan 1-4 Middle. Duty Cycle (%) [60]**

Use the <+> or <-> keys to adjust the maximum Chassis Fan 1-4 duty cycle. The values range from 20% to 100%. When the CPU temperature reaches the upper limit, the Chassis Fan 1-4 will operate at the maximum duty cycle.

**Chassis Fan 1-4 Lower Temperature [40]**

Use the <+> or <-> keys to adjust the lower limit of the Chassis Fan 1-4 temperature. The values range from 20 to 75. The Chassis Fan 1-4 will operate at the minimum duty cycle when the temperature is lower than the limit.

**Chassis Fan 1-4 Min. Duty Cycle(%) [60]**

Use the <+> or <-> keys to adjust the minimum Chassis Fan 1-4 fan duty cycle. The values range from 0% to 100%. When the CPU temperature is under the limit, the Chassis Fan 1-4 fan will operate at the minimum duty cycle.

**ASUS FAN EXTENSION CARD is required to configure these items**

**Extension Fan 1-3 Q-Fan Control [DC Mode]**

- [Disabled]      Disable the Extension Fan Q-Fan control feature.
- [DC mode]      Enable the Extension Fan Q-Fan control in DC mode for 3-pin chassis fan.
- [PWM mode]    Enable the Extension Fan Q-Fan control in PWM mode for 4-pin chassis fan.

**Extension Fan 1-3 Q-Fan Source [CPU]**

The assignment fan will be controlled according to the selected temperature source. Configuration options: [CPU] [MotherBoard] [VRM] [PCH] [T\_SENSOR1] [EXT\_Sensor1] [EXT\_Sensor2] [EXT\_Sensor3]



---

For EXT\_Sensor1-3, connect a Thermistor cable to the EXT\_TS1-3 header then place the other end to the component to get the temperature.

---

**Extension Fan 1-3 Fan Speed Low Limit [200 RPM]**

This item allows you to disable or set the chassis fan warning speed. Configuration options: [Ignore] [200 RPM] [300 RPM] [400 RPM] [500 RPM] [600 RPM]

### Extension Fan 1-3 Profile [Standard]

This item allows you to set the appropriate performance level of the CPU fan.

- [Standard] Set to make the CPU fan adjust automatically depending on the CPU temperature.
- [Silent] Set to minimize the fan speed for quiet CPU fan operation.
- [Turbo] Set to achieve maximum CPU fan speed.
- [Manual] Set to assign the detailed fan speed control parameters.



---

The following items appear only when you set the Extension Fan Profile to **[Manual]**.

---

#### ***Extension Fan 1-3 Upper Temperature [70]***

Use the <+> or <-> keys to adjust the upper limit of the Extension Fan 1-4 temperature. The values range from 20 to 75.

#### ***Extension Fan 1-3 Max. Duty Cycle (%) [100]***

Use the <+> or <-> keys to adjust the maximum Extension Fan 1-4 duty cycle. The values range from 20% to 100%. When the CPU temperature reaches the upper limit, the Extension Fan 1-4 will operate at the maximum duty cycle.

#### ***Extension Fan 1-3 Middle Temperature [45]***

Use the <+> or <-> keys to adjust the middle limit of the Extension Fan 1-4 temperature. The values range from 20 to 75.

#### ***Extension Fan 1-3 Middle. Duty Cycle (%) [60]***

Use the <+> or <-> keys to adjust the maximum Extension Fan 1-4 duty cycle. The values range from 20% to 100%. When the CPU temperature reaches the upper limit, the Extension Fan 1-4 will operate at the maximum duty cycle.

#### ***Extension Fan 1-3 Lower Temperature [40]***

Use the <+> or <-> keys to adjust the lower limit of the Extension Fan 1-4 temperature. The values range from 20 to 75. The Extension Fan 1-4 will operate at the minimum duty cycle when the temperature is lower than the limit.

#### ***Extension Fan 1-3 Min. Duty Cycle(%) [60]***

Use the <+> or <-> keys to adjust the minimum Extension Fan 1-4 duty cycle. The values range from 0% to 100%. When the CPU temperature is under the limit, the Extension Fan 1-4 will operate at the minimum duty cycle.

### Water Pump Control [Disabled]

- [Disabled] Disable the Water Pump control feature.
- [DC mode] Enable the Water Pump control in DC mode for 3-pin chassis fan.
- [PWM mode] Enable the Water Pump control in PWM mode for 4-pin chassis fan.



---

The following items appear only when you set the Water Pump Control to **[DC mode]** or **[PWM mode]**.

---

***Water Pump Upper Temperature [70]***

Use the <+> or <-> keys to adjust the upper limit of the Water Pump temperature. The values range from 20 to 75.

***Water Pump Max. Duty Cycle (%) [100]***

Use the <+> or <-> keys to adjust the maximum Extension Fan 1-4 duty cycle. The values range from 20% to 100%. When the CPU temperature reaches the upper limit, the Water Pump will operate at the maximum duty cycle.

***Water Pump Middle Temperature [45]***

Use the <+> or <-> keys to adjust the middle limit of the Water Pump temperature. The values range from 20 to 75.

***Water Pump Middle. Duty Cycle (%) [100]***

Use the <+> or <-> keys to adjust the maximum Water Pump duty cycle. The values range from 20% to 100%. When the CPU temperature reaches the upper limit, the Water Pump will operate at the maximum duty cycle.

***Water Pump Lower Temperature [40]***

Use the <+> or <-> keys to adjust the lower limit of the Water Pump temperature. The values range from 20 to 75. The Water Pump will operate at the minimum duty cycle when the temperature is lower than the limit.

***Water Pump Min. Duty Cycle(%) [100]***

Use the <+> or <-> keys to adjust the minimum Water Pump duty cycle. The values range from 0% to 100%. When the CPU temperature is under the limit, the Water Pump will operate at the minimum duty cycle.

### **Anti Surge Support [On]**

Enable this item for Over Voltage Protection (OVP) and Under Voltage Protection (UVP) functions.

Configuration options: [On] [Off]

### **Chassis Intrude Detect Support [Off]**

Enable this item for Chassis Intrude Detect Support function.

Configuration options: [On] [Off]

## 3.8 Boot menu

The Boot menu items allow you to change the system boot options.

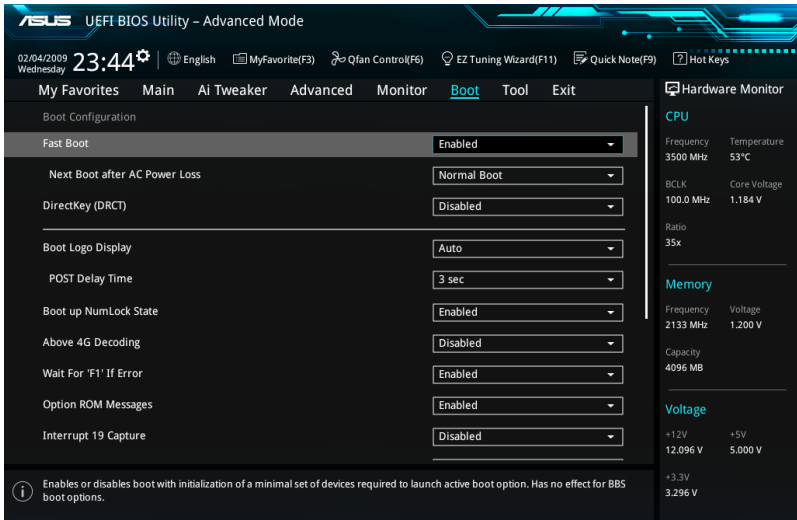

### Fast Boot [Enabled]

[Disabled] Allows your system to go back to its normal boot speed.

[Enabled] Allows your system to accelerate the boot speed.



The following items appear only when you set the Fast Boot to **[Enabled]**.

### Next Boot after AC Power Loss [Normal Boot]

[Normal Boot] Returns to normal boot on the next boot after an AC power loss.

[Fast Boot] Accelerates the boot speed on the next boot after an AC power loss.

### DirectKey (DRCT) [Enabled]

[Disabled] Disables the DirectKey button. The system will only power on or off when you press the DirectKey button.

[Enabled] Allows the system to power on and go to the BIOS Setup directly when you press the Reset button. Connect the 2-pin connector of the chassis reset button cable to the onboard DRCT header.

### Boot Logo Display [Auto]

[Auto] Sets the boot logo to display during POST.

[Full Screen] Sets the boot logo display in full screen during POST.

[Disabled] Disables the boot logo display during POST.



The following item appears only when you set the Boot Logo Display to **[Auto]** and **[Full Screen]**.

### Post Delay Time [3 sec]

This item allows you to select a desired additional POST waiting time to easily enter the BIOS Setup. You can only execute the POST delay time during normal boot. The values range from 0 to 10 seconds.



---

This feature only works when set under normal boot.

---



---

The following items appear only when you set the Boot Logo Display to **[Disabled]**.

---

### Post Report [5 sec]

This item allows you to select a desired POST report waiting time.  
Configuration options: [1 sec] - [10 sec] [Until Press ESC]

### Bootup NumLock State [Enabled]

This item allows you to enable or disable power-on state of the NumLock.  
Configuration options: [Disabled] [Enabled]

### Above 4G Decoding [Disabled]

This item enables or disables 64-bit capable devices to be decoded in above 4G address space if your system supports 64-bit PCI Decoding.

Configuration options: [Enabled] [Disabled]

### Wait For 'F1' If Error [Enabled]

This item allows your system to wait for the <F1> key to be pressed when error occurs.  
Configuration options: [Disabled] [Enabled]

### Option ROM Messages [Enabled]

[Enabled] The Option ROM Messages will be shown during the POST.  
[Disabled] Only the ASUS logo will be shown during the POST.

### Interrupt 19 Capture [Disabled]

[Enabled] Execute the trap right away.  
[Disabled] Execute the trap during legacy boot.

### Setup Mode [EZ Mode]

[Advanced Mode] This item allows you to go to Advanced Mode of the BIOS after POST.  
[EZ Mode] This item allows you to go to EZ Mode of the BIOS after POST.

## CSM (Compatibility Support Module)

This item allows you to configure the CSM (Compatibility Support Module) items to fully support the various VGA, bootable devices and add-on devices for better compatibility.

### Launch CSM [Enabled]

- [Auto] The system automatically detects the bootable devices and the add-on devices.
- [Enabled] For better compatibility, enable the CSM to fully support the non-UEFI driver add-on devices or the Windows® UEFI mode.
- [Disabled] Disable the CSM to fully support the non-UEFI driver add-on devices or the Windows® UEFI mode.



---

The following items appear only when you set the Launch CSM to **[Enabled]**.

---

### ***Boot Devices Control [UEFI and Legacy OPROM]***

This item allows you to select the type of devices that you want to boot.

Configuration options: [UEFI and Legacy OPROM] [Legacy OPROM only] [UEFI only]

### ***Boot from Network Devices [Legacy only]***

This item allows you to select the type of network devices that you want to launch.

Configuration options: [Legacy only] [UEFI driver first] [Ignore]

### ***Boot from Storage Devices [Legacy only]***

This item allows you to select the type of storage devices that you want to launch.

Configuration options: [Legacy only] [UEFI driver first] [Ignore]

### ***Boot from PCI-E/PCI Expansion Devices [Legacy only]***

This item allows you to select the type of PCI-E/PCI expansion devices that you want to launch.

Configuration options: [Legacy only] [UEFI driver first]

## Secure Boot

This item allows you to configure the Windows® Secure Boot settings and manage its keys to protect the system from unauthorized access and malwares during POST.

### OS Type [Windows UEFI mode]

- [Windows UEFI Mode] This item allows you to select your installed operating system. Execute the Microsoft® Secure Boot check. Only select this option when booting on Windows® UEFI mode or other Microsoft® Secure Boot compliant OS.
- [Other OS] Get the optimized function when booting on Windows® non-UEFI mode. Microsoft® Secure Boot only supports Windows® UEFI mode.

### Key Management

#### Install Default Secure Boot keys

This item allows you to clear all default Secure Boot keys.



## Save Secure Boot Keys

This item allows you to save the PK (Platform Keys) to a USB storage device.

### PK Management

#### Set New Key

This item allows you to load the downloaded PK from a USB storage device.



---

The PK file must be formatted as a UEFI variable structure with time-based authenticated variable.

---

#### Delete Key

This item allows you to delete the PK from your system. Once the PK is deleted, all the system's Secure Boot keys will not be active.

Configuration options: [Yes] [No]

### KEK Management



---

Key-exchange Key (KEK) refers to Microsoft® Secure Boot Key-Enrollment Key (KEK).

---

#### Delete Key

Allows you to delete the KEK from your system.

Configuration options: [Yes] [No]

#### Set New Key

Allows you to load the downloaded KEK from a USB storage device.

#### Append Key

Allows you to load the additional KEK from a storage device for an additional db and dbx loaded management.



---

The KEK file must be formatted as a UEFI variable structure with time-based authenticated variable.

---

### DB Management

#### Delete Key

Allows you to delete the db file from your system.

Configuration options: [Yes] [No]

#### Set New Key

Allows you to load the downloaded db from a USB storage device.

#### Append Key

Allows you to load the additional db from a storage device so that more images can be loaded securely.



---

The db file must be formatted as a UEFI variable structure with time-based authenticated variable. DBX Management

---

## DBX Management

### Delete Key

Allows you to delete the dbx file from your system.

### Set New Key

Allows you to load the downloaded dbx from a USB storage device.

Configuration options: [Yes] [No]

### Append Key

Allows you to load the additional dbx from a storage device so that more db's images cannot be loaded.



---

The dbx file must be formatted as a UEFI variable structure with time-based authenticated variable.

---

## Boot Option Priorities

These items specify the boot device priority sequence from the available devices. The number of device items that appears on the screen depends on the number of devices installed in the system.



- To access Windows® OS in Safe Mode, press <F8> after POST (Windows® 8 not supported).
  - To select the boot device during system startup, press <F8> when the ASUS Logo appears.
- 

## Boot Override

These items displays the available devices. The number of device items that appears on the screen depends on the number of devices installed in the system. Click an item to start booting from the selected device.

## 3.9 Tool menu

The Tool menu items allow you to configure options for special functions. Select an item then press <Enter> to display the submenu.

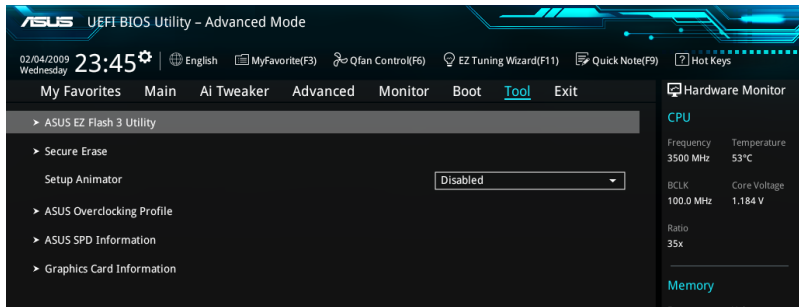

### Setup Animator [Disabled]

This item allows you to enable or disable the Setup animator.

Configuration options: [Disabled] [Enabled]

### 3.9.1 ASUS EZ Flash 3 Utility

This item allows you to run ASUS EZ Flash 3. When you press <Enter>, a confirmation message appears. Use the left/right arrow key to select between [Yes] or [No], then press <Enter> to confirm your choice.



For more details, refer to section 3.11.2 **ASUS EZ Flash 3**.

### 3.9.2 Secure Erase

SSD speeds may lower over time as with any storage medium due to data processing. Secure Erase completely and safely cleans your SSD, restoring it to factory performance levels.



Secure Erase is only available in AHCI mode. Ensure to set the SATA mode to AHCI. Click **Advanced > SATA Configuration > AHCI**.

To launch Secure Erase, click **Tool > Secure Erase** on the Advanced mode menu.



Check the ASUS support site for a full list of SSDs tested with Secure Erase. The drive may become unstable if you run Secure Erase on an incompatible SSD.



- The time to erase the contents of your SSD may take a while depending on its size. Do not turn off the system during the process.
- Secure Erase is only supported on Intel SATA port. For more information about Intel SATA ports, refer to section 1.2.2 **Motherboard layout** of this manual.

Displays the available SSDs

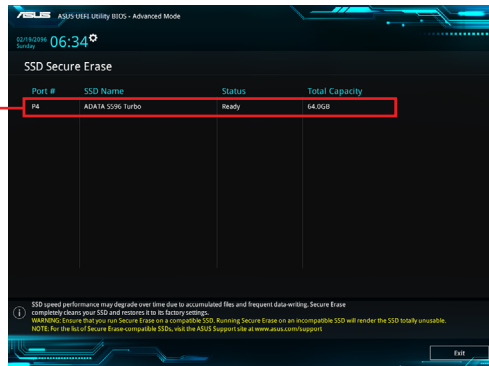

### Status definition:

- **Frozen.** The frozen state is the result of a BIOS protective measure. The BIOS guards drives that do not have password protection by freezing them prior to booting. If the drive is frozen, a power off or hard reset of your PC must be performed to proceed with the Secure Erase.
- **Locked.** SSDs might be locked if the Secure Erase process is either incomplete or was stopped. This may be due to a third party software that uses a different password defined by ASUS. You have to unlock the SSD in the software before proceeding with Secure Erase.

### 3.9.3 ASUS Overclocking Profile

This item allows you to store or load multiple BIOS settings.

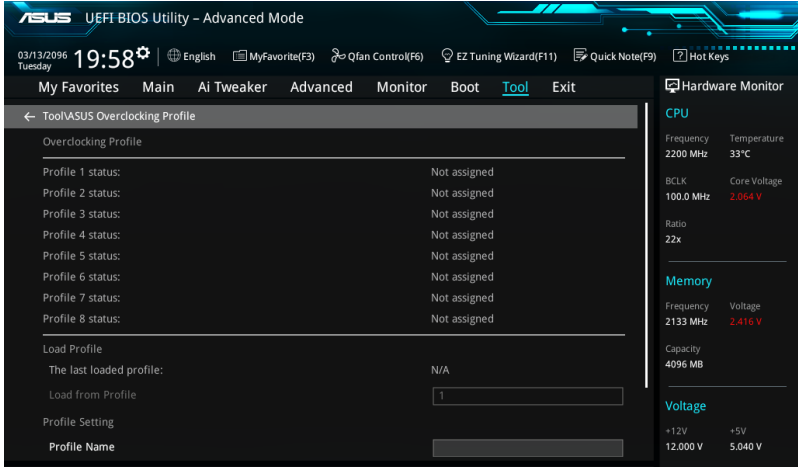

#### Load from Profile

This item allows you to load the previous BIOS settings saved in the BIOS Flash. Key in the profile number that saved your BIOS settings, press <Enter>, and then select **Yes**.



- DO NOT shut down or reset the system while updating the BIOS to prevent the system boot failure!
- We recommend that you update the BIOS file only coming from the same memory/ CPU configuration and BIOS version.

#### Profile Name

This item allows you to key in a profile name.

#### Save to Profile

This item allows you to save the current BIOS settings to the BIOS Flash, and create a profile. Key in a profile number from one to eight, press <Enter>, and then select **Yes**.

#### Load/Save Profile from/to USB Drive

This item allows you to load or save profile from your USB drive, load and save profile to your USB drive.

### 3.9.4 ASUS SPD Information

This item allows you to view the DRAM SPD information.

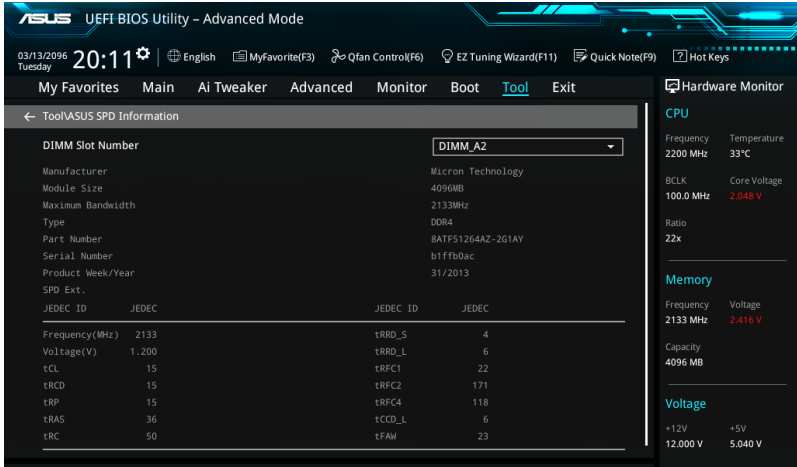

### 3.9.5 Graphics Card Information

This item displays the information about the graphics card installed in your system.

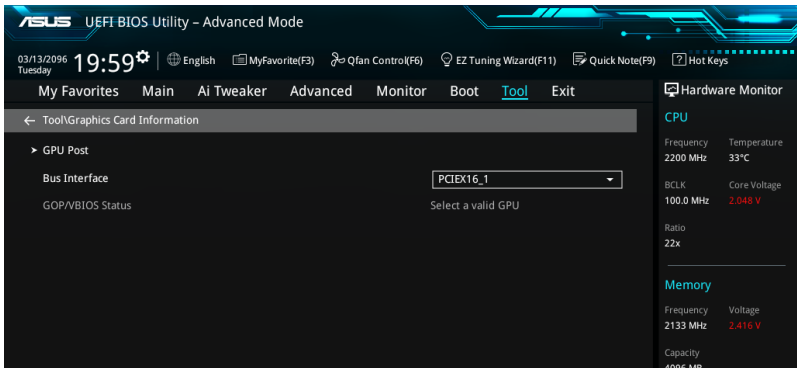

#### GPU Post

This item displays the information and recommended configuration for the PCIE slots that the graphics card is installed in your system.

#### Bus Interface

This item allows you to select the bus interface.

Configuration options: [PCIEX16\_1] [PCIEX16\_2]

## 3.10 Exit menu

The Exit menu items allow you to load the optimal default values for the BIOS items, and save or discard your changes to the BIOS items. You can access the EZ Mode from the Exit menu.

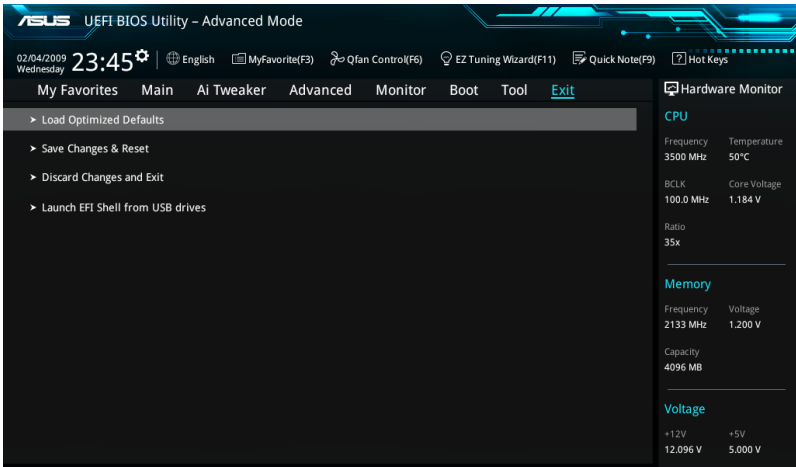

### Load Optimized Defaults

This option allows you to load the default values for each of the parameters on the Setup menus. When you select this option or if you press <F5>, a confirmation window appears. Select **OK** to load the default values.

### Save Changes & Reset

Once you are finished making your selections, choose this option from the Exit menu to ensure the values you selected are saved. When you select this option or if you press <F10>, a confirmation window appears. Select **OK** to save changes and exit.

### Discard Changes & Exit

This option allows you to exit the Setup program without saving your changes. When you select this option or if you press <Esc>, a confirmation window appears. Select **Yes** to discard changes and exit.

### Launch EFI Shell from filesystem device

This option allows you to attempt to launch the EFI Shell application (shellx64.efi) from one of the available filesystem devices.

## 3.11 Updating BIOS

The ASUS website publishes the latest BIOS versions to provide enhancements on system stability, compatibility, and performance. However, BIOS updating is potentially risky. If there is no problem using the current version of BIOS, DO NOT manually update the BIOS. Inappropriate BIOS updating may result to system's failure to boot. Carefully follow the instructions in this chapter to update your BIOS when necessary.



---

Visit <http://www.asus.com> to download the latest BIOS file for this motherboard.

---

The following utilities allow you to manage and update the motherboard BIOS setup program.

1. EZ Update: Updates the BIOS in Windows® environment.
2. ASUS EZ Flash 3: Updates the BIOS using a USB flash drive.
3. ASUS CrashFree BIOS 3: Restores the BIOS using the motherboard support DVD or a USB flash drive when the BIOS file fails or gets corrupted.

### 3.11.1 EZ Update

The EZ Update is a utility that allows you to update the motherboard BIOS in Windows® environment.



- 
- EZ Update requires an Internet connection either through a network or an ISP (Internet Service Provider).
  - This utility is available in the support DVD that comes with the motherboard package.
  - Refer to section **4.4.3 EZ Update** of this user guide for more information.
-



### 3.11.2 ASUS EZ Flash 3

ASUS EZ Flash 3 allows you to download and update to the latest BIOS through the Internet without having to use a bootable floppy disk or an OS-based utility.



Updating through the Internet varies per region and Internet conditions. Check your local Internet connection before updating through the Internet.

#### To update the BIOS by USB:

1. Enter the Advanced Mode of the BIOS setup program. Go to the Tool menu to select **ASUS EZ Flash Utility** and press <Enter>.
2. Insert the USB flash disk that contains the latest BIOS file to the USB port.
3. Select **by USB**.

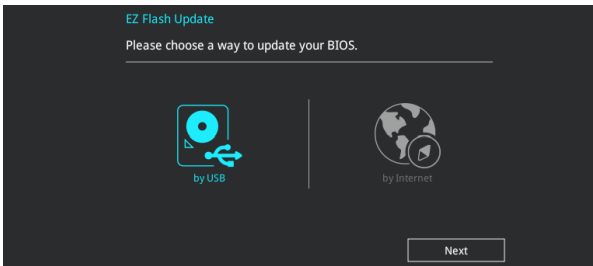

4. Press <Tab> to switch to the Drive field.
5. Press the Up/Down arrow keys to find the USB flash disk that contains the latest BIOS, and then press <Enter>.
6. Press <Tab> to switch to the Folder Info field.
7. Press the Up/Down arrow keys to find the BIOS file, and then press <Enter> to perform the BIOS update process. Reboot the system when the update process is done.

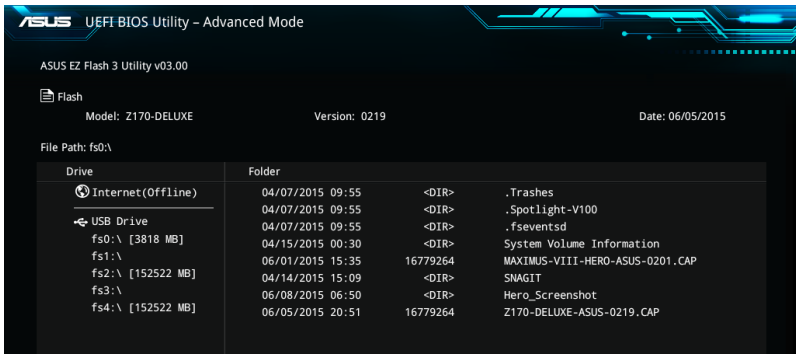



- This function can support devices such as a USB flash disk with FAT 32/16 format and single partition only.
- DO NOT shut down or reset the system while updating the BIOS to prevent system boot failure!



Ensure to load the BIOS default settings to ensure system compatibility and stability. Select the Load Optimized Defaults item under the Exit menu. See section 3.10 **Exit Menu** for details.

### To update the BIOS by Internet:

1. Enter the Advanced Mode of the BIOS setup program. Go to the Tool menu to select **ASUS EZ Flash Utility** and press <Enter>.
2. Select **by Internet**.

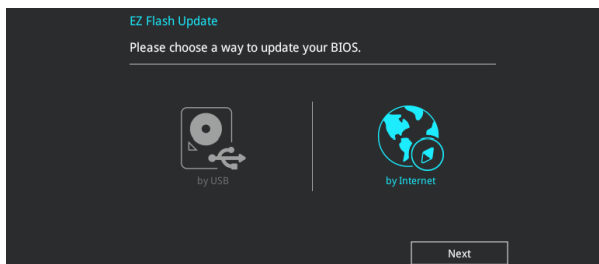

3. Press the Left/Right arrow keys to select an Internet connection method, and then press <Enter>.

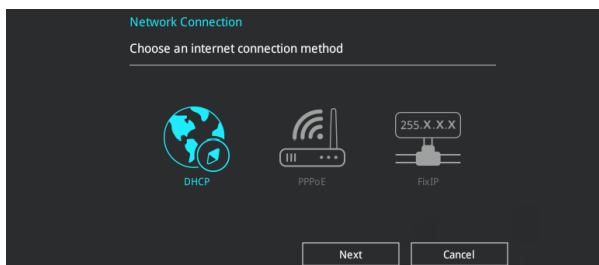

4. Follow the onscreen instructions to complete the update.
5. Reboot the system when the update process is done.



Ensure to load the BIOS default settings to ensure system compatibility and stability. Select the Load Optimized Defaults item under the Exit menu. See section 3.10 **Exit Menu** for details.

### 3.11.3 ASUS CrashFree BIOS 3

The ASUS CrashFree BIOS 3 utility is an auto recovery tool that allows you to restore the BIOS file when it fails or gets corrupted during the updating process. You can restore a corrupted BIOS file using the motherboard support DVD or a USB flash drive that contains the BIOS file.



---

The BIOS file in the motherboard support DVD may be older than the BIOS file published on the ASUS official website. If you want to use the newer BIOS file, download the file at <https://www.asus.com/support/> and save it to a USB flash drive.

---

#### Recovering the BIOS

##### To recover the BIOS:

1. Turn on the system.
2. Insert the motherboard support DVD to the optical drive, or the USB flash drive containing the BIOS file to the USB port.
3. The utility automatically checks the devices for the BIOS file. When found, the utility reads the BIOS file and enters ASUS EZ Flash 3 automatically.
4. The system requires you to enter BIOS Setup to recover the BIOS setting. To ensure system compatibility and stability, we recommend that you press <F5> to load default BIOS values.



---

**DO NOT** shut down or reset the system while updating the BIOS! Doing so can cause system boot failure!

---



# Software Support

# 4

## 4.1 Installing an operating system

---



Motherboard settings and hardware options vary. The setup procedures presented in this chapter are for reference only. Refer to Windows® operating system documentation for detailed information.

---

### 4.1.1 Windows® 7 and USB 3.0 driver for 100 Series

Based on the chipset specification, the 100 series requires USB 3.0 drivers to be preloaded in order to use USB keyboard/mouse during Windows® 7 installation. This section is a guide on preloading USB 3.0 drivers and installing Windows® 7.

#### Method 1: Using SATA ODD & USB devices

Load USB 3.0 drivers using the ASUS support DVD and install Windows® 7 using a USB device.

##### Requirement:

- 1 x ASUS support DVD
- 1 x Windows® 7 installation source
- 1 x SATA ODD
- 1 x USB device (ODD or storage)



The USB storage device requires 8 GB or more capacity. It is recommended to format the storage device before use.

---

1. Insert the Windows® 7 installation DVD into a USB ODD, or copy all files on the Windows® 7 installation DVD to a USB storage device on a working system.
2. Connect the USB ODD or USB storage device to your 100 series platform.
3. Insert the ASUS support DVD into a SATA ODD on your 100 series platform.
4. Power on your system and press F8 during POST (Power-On Self Test) to enter the boot screen.

5. Select the USB ODD or USB storage device as the boot device.

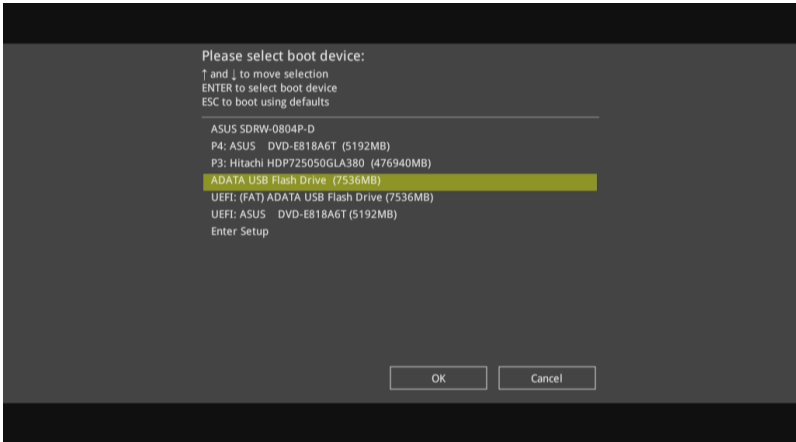

6. The USB 3.0 driver will be loaded automatically during installation startup.

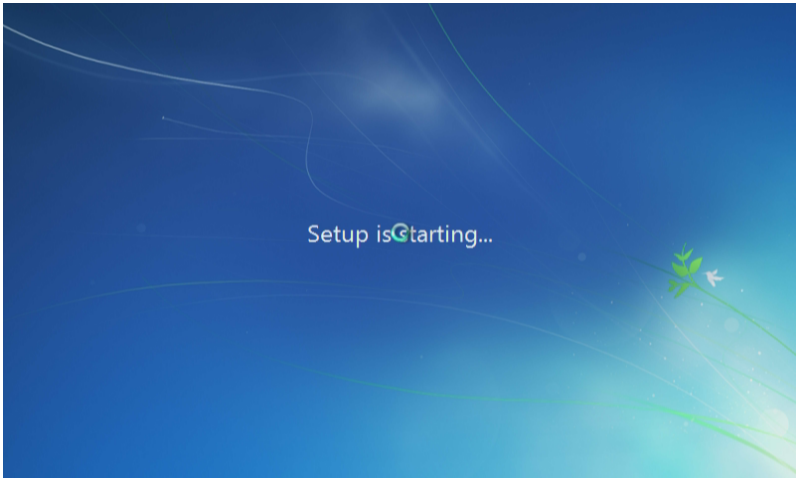

The "Setup is starting..." screen will show up if the USB 3.0 driver is loaded correctly.

7. Follow the onscreen instructions to complete the Windows® 7 installation.

## Method 2: Using a modified Windows® 7 ISO

Load USB 3.0 drivers and install Windows® 7 using a modified Windows® 7 installation DVD.

### Requirement:

- 1 x ASUS support DVD
  - 1 x Windows® 7 installation source
  - 1 x Working system (PC or notebook)
  - 1 x SATA ODD
1. On your working system, create an ISO image file of the Windows® 7 installation source using a third-party ISO software.
  2. Copy both "Auto\_Unattend.xml" and "Auto\_Unattend" folder from the root directory of the ASUS supporting DVD to your system.
  3. Edit the ISO file and add both "Auto\_Unattend.xml" and "Auto\_Unattend" folder into the ISO file.
  4. Burn this ISO file onto an empty DVD to create a modified Windows® 7 installation DVD.
  5. Insert the modified Windows® 7 installation DVD into an ODD on your 100 series platform.
  6. Power on your system and press F8 during POST (Power-On Self Test) to enter the boot screen.
  7. Select the ODD as the boot device.
  8. The USB 3.0 driver will be loaded automatically during installation startup.



---

The "Setup is starting..." screen will show up if the USB 3.0 driver is loaded correctly.

---

9. Follow the onscreen instructions to complete the Windows® 7 installation.

### Method 3: Using ASUS EZ Installer

Use the ASUS EZ Installer to create a modified Windows® 7 installation source.

#### Requirement:

- 1 x ASUS support DVD
- 1 x Windows® 7 installation DVD
- 1 x Working system (PC or notebook)
- 1 x SATA ODD
- 1 x USB storage device (8 GB or more)

1. Insert the Windows® 7 installation DVD.
2. Launch the ASUS EZ Installer located on the ASUS support DVD.
3. Select a method of creating a modified Windows® 7 installation file:
  - Windows® 7 OS disk to USB storage device

- Select **Windows 7 OS disk to USB storage device** then click **Next**.

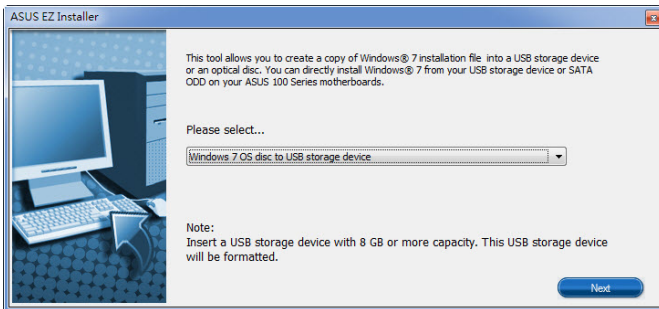

- Check **I agree** and then click **Next**.

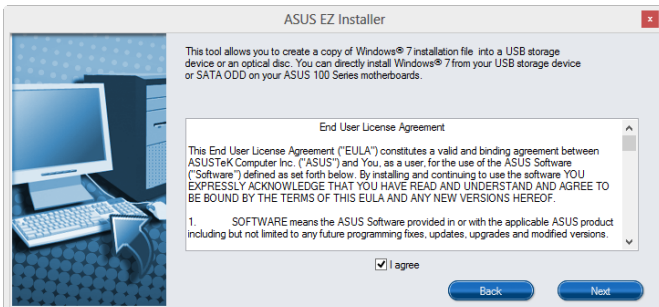



- Select the source of the Windows® 7 installation disk then click **Next**.

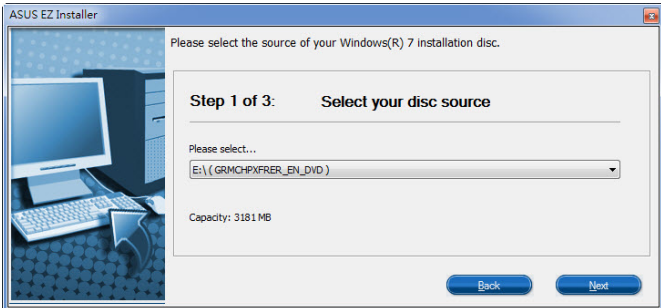

- Select the USB storage device and click **next**.



Click the refresh icon  if the USB storage device is not displayed.

- Click **Yes** to clear the contents on the USB storage device and create a bootable USB device.



Make sure to backup contents on the USB storage device, as it will be formatted.

- Once completed, click **OK** to finish.

- Windows® 7 OS disk to ISO file
  - Select **Windows 7 OS disk to ISO file** then click **Next**.

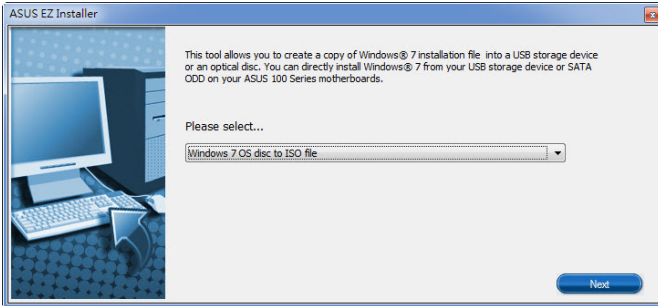

- Check **I agree** and then click **Next**.

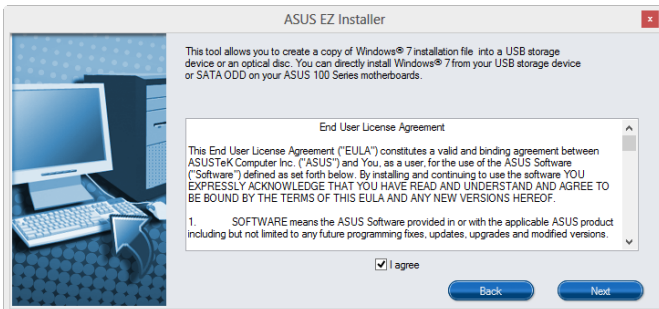

- Select the source of the Windows® 7 installation disk then click **Next**.

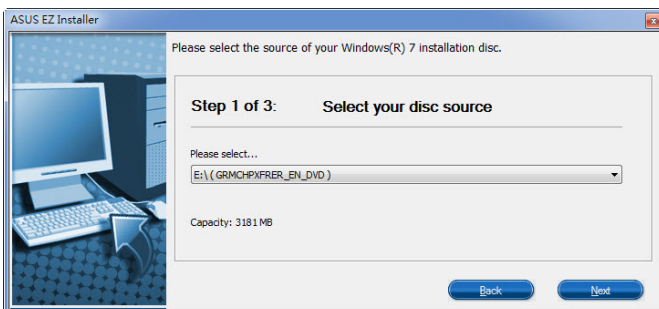

- Select the folder to save the modified Windows® 7 installation ISO file and click **Next**.

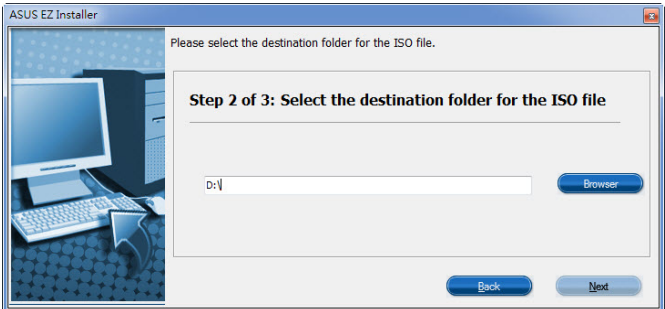

- Once completed, click OK to finish.
  - Burn this ISO file onto an empty DVD to create a modified Windows® 7 installation DVD.
4. Insert the modified Windows® 7 installation DVD into an ODD or connect the USB storage device with modified Windows® 7 installation files onto your 100 series platform.
  5. Power on your system and press F8 during POST (Power-On Self Test) to enter the boot screen.
  6. Select the ODD or USB storage device as the boot device.
  7. The USB 3.0 driver will be loaded automatically during installation startup.



---

The "Setup is starting..." screen will show up if the USB 3.0 driver is loaded correctly.

---

8. Follow the onscreen instructions to complete the Windows® 7 installation.

## 4.2 Support DVD information



The contents of the support DVD are subject to change at any time without notice. Visit the ASUS website at [www.asus.com](http://www.asus.com) for updates.

### 4.2.1 Running the support DVD



Ensure that you have an Administrator account before running the support DVD in your operating system.

To run the Support DVD:

1. Place the Support DVD into the optical drive.
2. In the **AutoPlay** dialog box, Click **Run Instv2.EXE**.

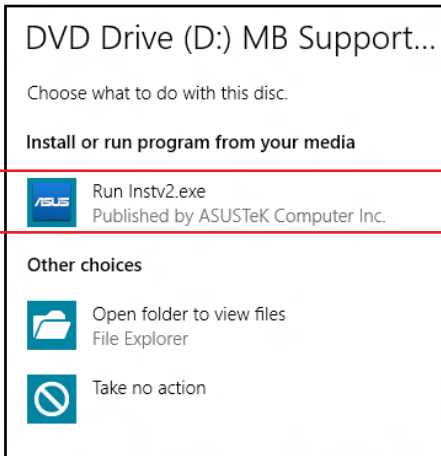

If the **AutoPlay** dialog box does not appear, browse the contents of the support DVD and double-click `\\bin\\Instv2.EXE` to launch the **ASUS motherboard support DVD** main menu.

## Support DVD main menu

Shows the available device drivers if the system detects installed devices. Install the necessary drivers to use the devices.

Click to display the applications and other software that the motherboard supports

Contains the list of supplementary user manuals. Click an item to open the folder of the user guide

Click to display free software for you to use

Click to select an item to install

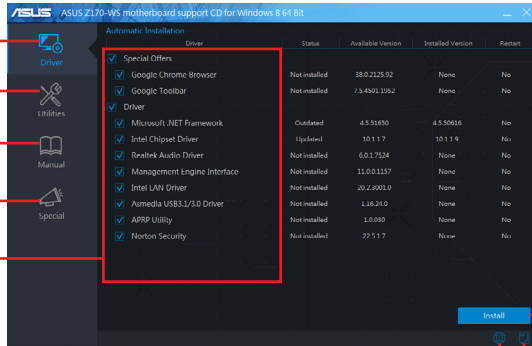

Click to display the ASUS contact information

Click to browse the file list of the support CD

Click to install the selected items

## 4.2.2 Obtaining the software manuals

The software manuals are included in the support DVD. Follow the instructions below to get the necessary software manuals.



The software manual files are in Portable Document Format (PDF). Install the Adobe® Acrobat® Reader from the **Utilities** tab before opening the files.

To read about your motherboard's software manual:

1. Run the Support DVD.
2. In the Support DVD main menu, click the **Manual** tab.
3. Click the software manual that you wish to read.

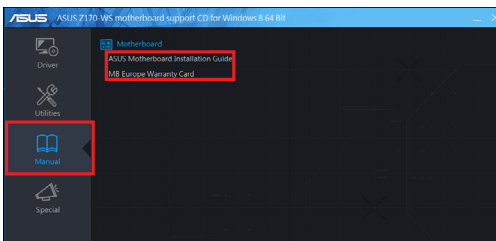

## 4.3 Software information

Most of the applications in the support DVD have wizards that will conveniently guide you through the installation. View the online help or readme file that came with the software application for more information.

## 4.4 AI Suite 3

AI Suite 3 is an all-in-one interface that integrates several ASUS utilities and allows you to launch and operate these utilities simultaneously.

### Installing AI Suite 3



---

Ensure that you have an Administrator account before installing AI Suite 3 in your operating system.

---

To install AI Suite 3 on your computer:

#### Windows® 7 OS

1. Place the Support DVD into the optical drive.
2. In the **AutoPlay** dialog box, Click **Run Instv2.EXE** then select the **Utilities** tab.

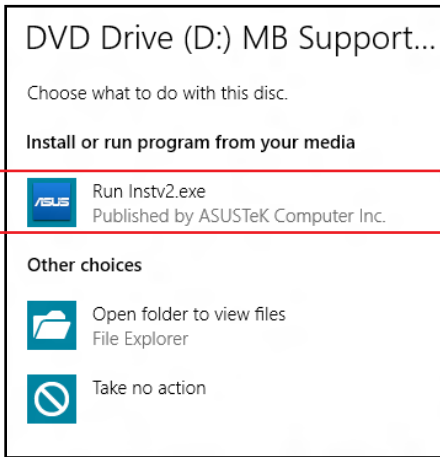

3. From the **Utilities** tab, Click **AI Suite 3** then follow the succeeding onscreen instructions.

## Windows® 8.1 OS

1. Place the Support DVD into the optical drive then follow onscreen instructions.
2. From the **ASUS motherboard support DVD** main menu, select the Utilities tab and Click **AI Suite 3**.
3. Follow the succeeding onscreen instructions.

If the **ASUS motherboard support DVD** main menu did not appear, try the following:

- a. Go to the **Start Screen** then Click the **Desktop** app.
- b. On the lower left corner of the Desktop, Click **File Explorer**  then select your DVD drive and tap or double-Click the **Setup** application.

## Launching AI Suite 3

### Windows® 7 OS

From the Desktop, Click **Start > All Programs > ASUS > AI Suite 3 > AI Suite 3**.

You can also launch AI Suite in Windows® 7 by clicking or tapping  on the Notification area.

### Windows® 8.1 OS

To launch AI Suite 3 in Windows® 8.1, tap the AI Suite 3 app on the Start Screen (or if you're using a mouse, Click the AI Suite 3 app on the Start Screen).

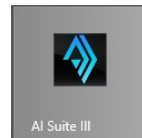

## AI Suite 3 Main menu

The AI Suite 3 main menu gives you easy-access controls and insight to what's going on with your computer - allowing you to optimize performance settings while at the same time ensuring system stability.

The AI Suite main menu includes a quick-access menu bar that allows you to swiftly launch any of the integrated ASUS utilities. Click  on the left of the menu to launch the menu bar.



The AI Suite 3 screenshots in this section are for reference only and can vary depending on motherboard model.

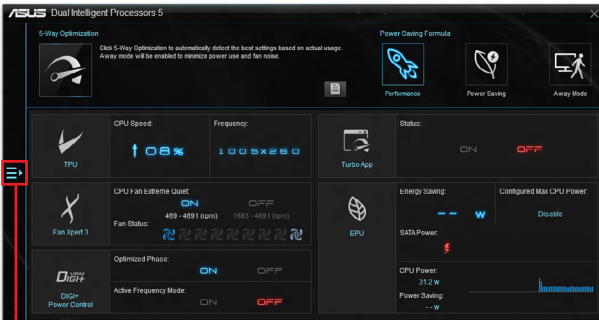

Click to launch AI Suite 3 menu bar

## AI Suite 3 main menu bar

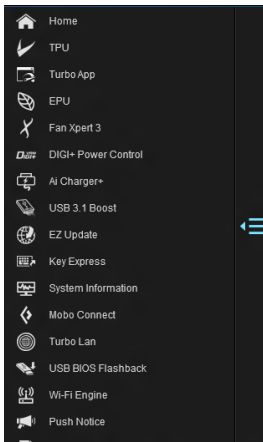

- Some functions in the AI Suite 3 main menu in this user guide may vary depending on the motherboard model.
- Refer to the software manual in the support DVD or visit the ASUS website at [www.asus.com](http://www.asus.com) for detailed software configuration.



## AI Suite 3 mini-menu

The AI Suite 3 mini-menu appears on the desktop and can be conveniently accessed and moved around. The AI Suite 3 mini-menu allows you to quickly access the important items in the AI Suite 3.

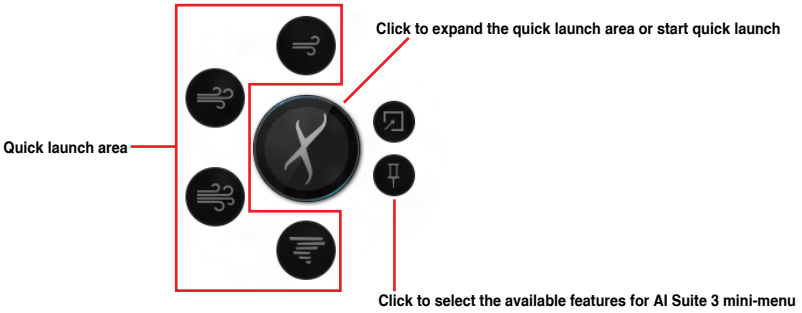

## 4.4.1 Ai Charger+

Ai Charger+ allows you to fast-charge your portable BC 1.1\* mobile devices on your computer's USB port three times faster than the standard USB devices\*\*.

### Launching Ai Charger+

To launch Ai Charger+, click  on the left of the AI Suite 3 main menu, then select **Ai Charger+**.



---

Ai Charger+ is available only in selected motherboard models.

---

### Ai Charger+ screen



Tick to enable or disable Ai Charger+

Click to apply the selection



- \* Check the manufacturer if your USB device is a Battery Charging Specification 1.1 (BC 1.1) compliant or compatible device.
  - \*\* Actual charging speeds may vary depending on the charging rate and specifications of your USB device.
  - To ensure normal charging function, disconnect and reconnect your USB device every time you enable or disable Ai Charger+.
  - Ai Charger+ does not support USB hubs, USB extension cables, and generic USB cables.
-

## 4.4.2 USB 3.1 Boost

USB 3.1 Boost technology supports UASP (USB Attached SCSI Protocol) that automatically speeds up the transfer rates of your USB storage devices.

### Launching USB 3.1 Boost

To launch USB 3.1 Boost, click  on the left of the AI Suite 3 main menu, then select **USB 3.1 Boost**.

### Using the USB 3.1 Boost



Ensure to connect your USB 3.1/3.0 devices to the USB 3.1/3.0 ports that support USB 3.1 Boost. For more details, refer to section **2.3.1 Rear I/O connection**.



- USB 3.1 Boost automatically detects the USB 3.1/3.0 devices that support UASP.
- The data transfer speed varies with USB devices. For a higher data transfer performance, use a USB 3.1/3.0 device.

### 4.4.3 EZ Update

EZ Update is a utility that allows you to automatically update your motherboard's software, drivers and BIOS easily.

With this utility, you can also manually update the BIOS and select the boot logo that displays during POST.

#### Launching EZ Update

To launch EZ Update, click  on the left of the AI Suite 3 main menu, then select **EZ Update**.

#### Using EZ Update

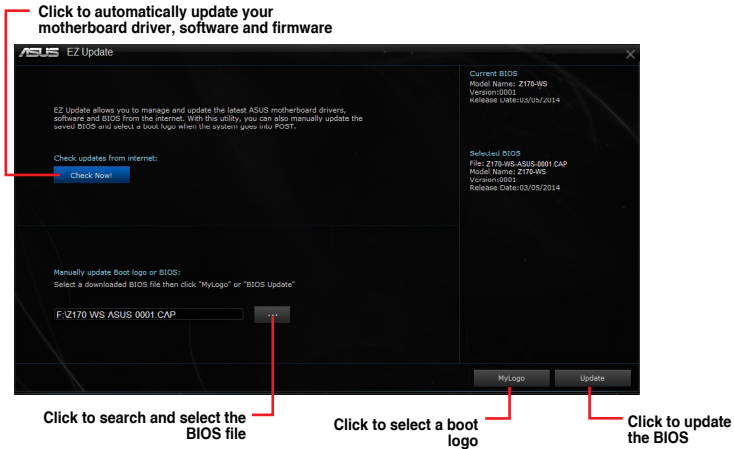

## Manually update the BIOS and selecting a boot logo

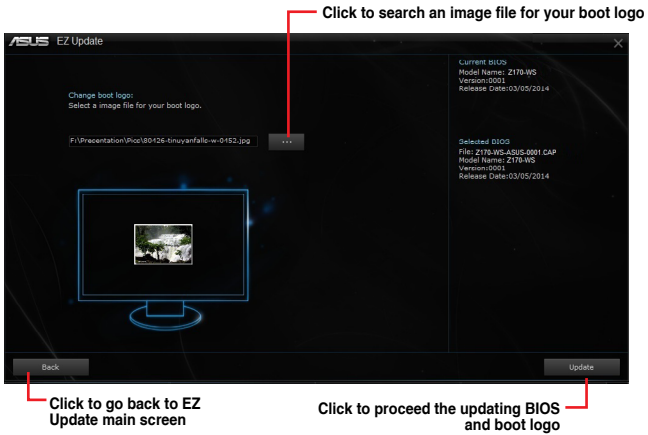

After you Click **BIOS Update** button, Click **Flash** to update the BIOS and upload the boot logo in your system.

## 4.4.4 USB BIOS Flashback

USB BIOS Flashback allows you to check and save the latest BIOS version to a USB storage device. Use this utility to quickly check for the latest available BIOS and set the BIOS download schedule.

### Launching USB BIOS Flashback

To launch USB BIOS Flashback, click  on the left of the AI Suite 3 main menu, then select **USB BIOS Flashback**.



USB BIOS Flashback is available only in selected motherboard models.

### Using USB BIOS Flashback

**Set a schedule for the BIOS Update download**



Click to check for a new BIOS update available for download

Click to cancel the download schedule setting

Click to apply the download schedule setting

### Scheduling the BIOS download

1. In the Download Setting field, tick **Schedule (days)** then select the number of days for the BIOS download schedule.
2. Click **Apply** to save the BIOS download schedule. Click **Cancel** to cancel the download schedule.

## Downloading the latest BIOS





Before you start downloading, ensure that you have installed the USB storage device to your computer's USB port that supports USB BIOS Flashback. Refer to section **2.3.1 Rear I/O connection** of this user guide for more details.

To download the updated BIOS:

1. From the USB BIOS Flashback screen, Click **Check for New BIOS Update**.

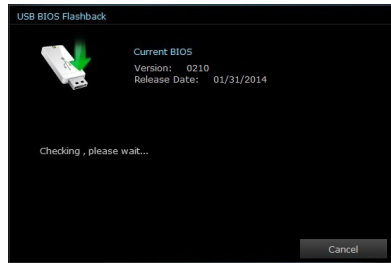
Wait for the system to check the latest BIOS version.



2. After the utility detects a new BIOS, Click  from the Save to: field, select the USB flash drive, then Click **Download**.

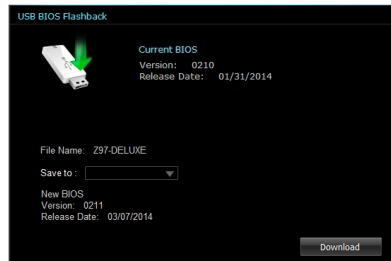

3. After the download is complete, Click **OK**.

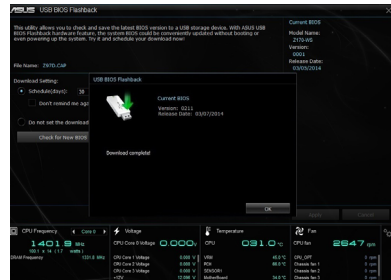

## 4.4.5 Push Notice

This utility allows you get the detailed status of your system to your smart device. You can also send messages to your smart device using this utility.



Before using this utility, ensure that you pair your computer with your smart device. For pairing information, refer to section **Pairing your computer and smart device**.

### Launching Push Notice on your computer

To launch Push Notice, click  on the left of the AI Suite 3 main menu, then select **Push Notice**.

### Push Notice screen

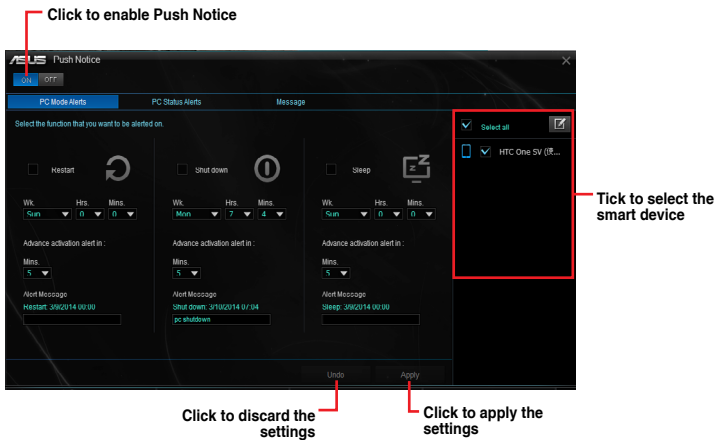

You can also enable the Push Notice via the Push Notice shortcut on the lower-right corner of your screen. To do this, Click << then Click  then select .

### Pairing your computer and smart device

To pair your computer and smart device:

1. On your smart device, tap  to launch Push Notice.
2. Tap **Push Scan** then tap the name of your computer that you want to pair with.



To pair your computer and smart device, ensure that both are connected to the same wireless network.



## Setting up PC Mode alerts of your computer

This feature allows you to restart, shut down, or put your computer to sleep mode and sends an alert to your smart device.



The screenshot shows the 'ASUS Push Notice' application window with the 'PC Mode Alerts' tab selected. The interface is divided into three columns for 'Restart', 'Shut down', and 'Sleep'. Each column has a function icon, a 'Select the function that you want to be alerted on' dropdown menu, and an 'Advance activation alert in' section with 'Mins.' and 'Alert Message' fields. A 'Message' tab on the right shows a selected device 'HTC One SV (R...)'.

**Tick these to enable mode alerts** (points to the function icons)

**Set the day and time to enable the PC modes** (points to the 'Wk.' dropdowns)

**Set the minutes to send the alert before the PC mode/s activation** (points to the 'Mins.' dropdowns)

**Key in your messages for more information** (points to the 'Alert Message' text boxes)

**Tick to select the smart device** (points to the 'HTC One SV (R...)' selection)

## Setting up PC Status alerts

This feature allows you to send alerts of the unusual activities of the voltage, temperature, and fan settings of your computer to your smart device.

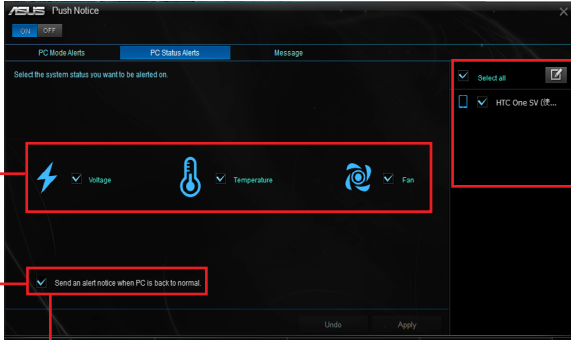

The screenshot shows the 'ASUS Push Notice' application window with the 'PC Status Alerts' tab selected. The interface has a 'Select the system status you want to be alerted on.' section with three options: 'Voltage', 'Temperature', and 'Fan', each with a checkmark. Below this is a checkbox 'Send an alert notice when PC is back to normal.' The 'Message' tab on the right shows the same device selection as the previous screenshot.

**Tick to select and send alerts to your smart device** (points to the 'Voltage', 'Temperature', and 'Fan' options)



**Tick to select the smart device** (points to the 'HTC One SV (R...)' selection)

**Tick to send alert when the components selected are back to its normal status** (points to the 'Send an alert notice when PC is back to normal.' checkbox)

## Sending messages to your smart device

This feature allows you to send messages to your smart device.



You can also send messages via the Push Notice messaging shortcut on the lower-right corner of your screen. To do this, Click << then Click  then select .

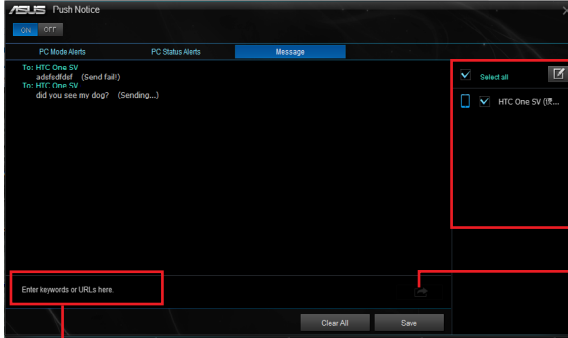

Tick to select the smart device

Click to send your message

Click to key in your message

## Viewing your computer status on your smart device

Tap  on your smart device to launch Push Notice.

Push Notice

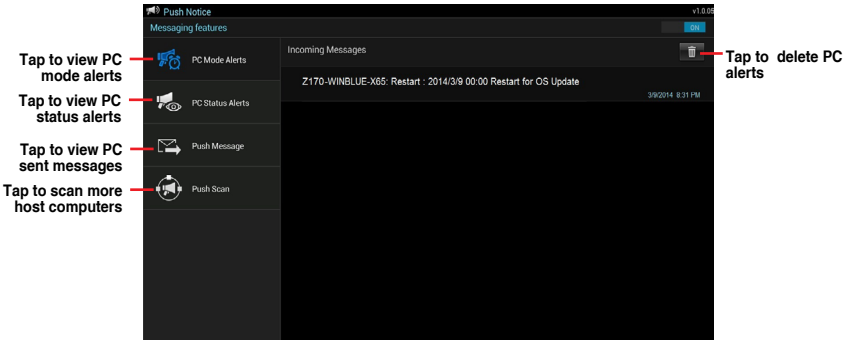

Tap to view PC mode alerts

Tap to view PC status alerts

Tap to view PC sent messages

Tap to scan more host computers

Tap to delete PC alerts

## 4.4.6 System Information

This utility allows you get the detailed information of the motherboard, CPU, and memory settings.

### Launching the System Information

To launch System Information, click  on the left of the AI Suite 3 main menu, then select **System Information**.

### Viewing the motherboard information

Click the **MB** tab to view the motherboard's information.

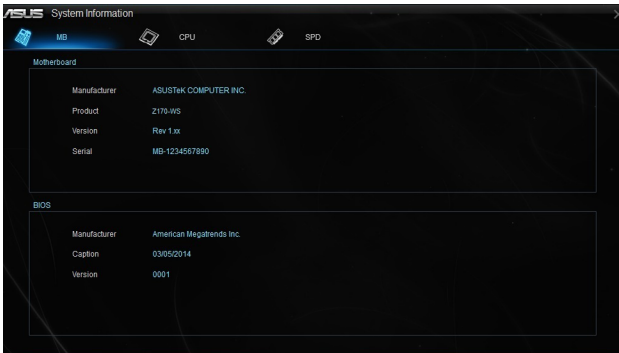

### Viewing the CPU information

Click the **CPU** tab to view the processor's information.

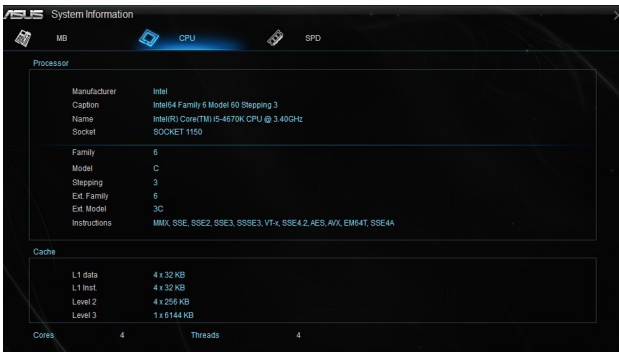

## Viewing the SPD information

Click the **SPD** tab to view the memory's information.

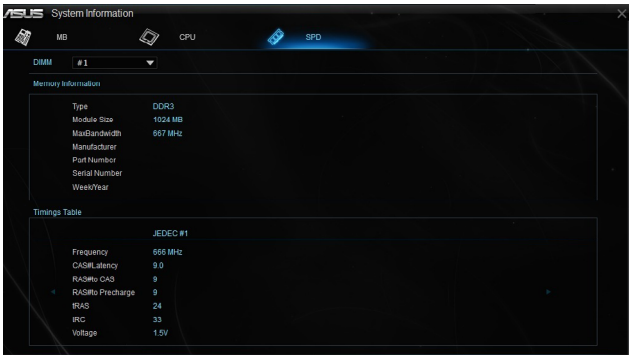

## 4.4.7 Key Express

Key Express is a built-in microprocessor that provides instant upgrade to your keyboard. You can configure and assign macros to specific keys on your keyboard to perform specific or several task at the same time.

1. Connect the USB keyboard into the dedicated Key Express USB port.



Refer to the **Rear I/O connection** section for more information about the location of the Key Express USB port.

2. Click  on the left of the AI Suite 3 main menu, then select **Key Express**.

### Macro Keys

Click to import or export configuration files

Tick to toggle the Key Express function on/off

Click to configure Macro keys, Windows login, Function keys, and Shortcut settings

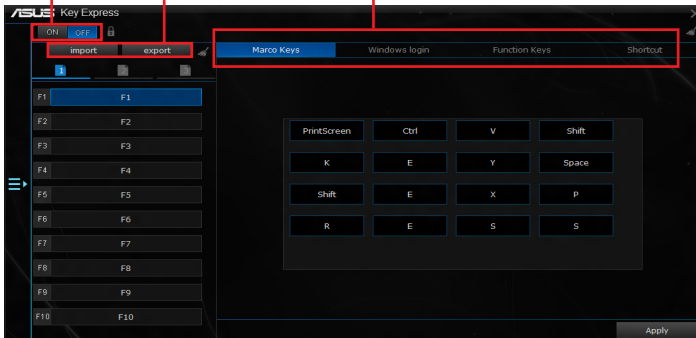

### Windows Login

Select Windows account order and enter your password

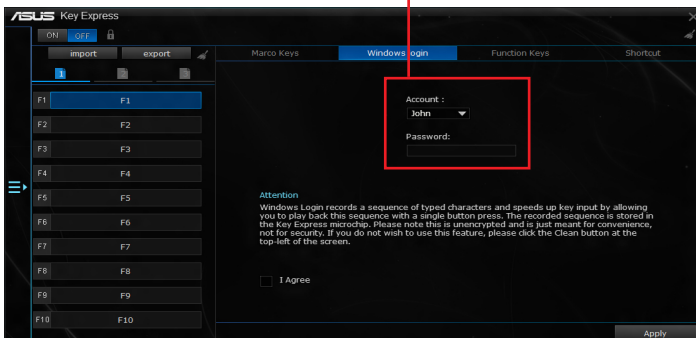

- This function is meant for convenience, not for security.
- This function is not supported at the account switch screen.

## Function Keys

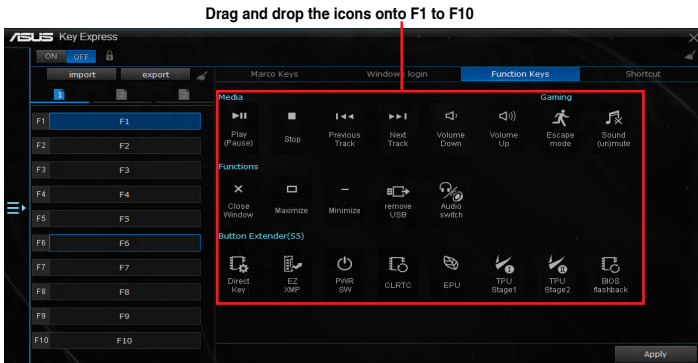

Set the power-on button to a hotkey to use it to wake up your PC when Key Express is installed.

## Shortcut

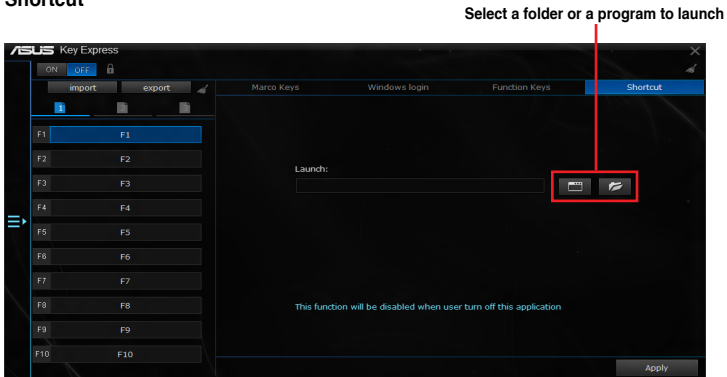

## 4.5 Audio configurations

The Realtek® audio CODEC provides 8-channel audio capability to deliver the ultimate audio experience on your computer. The software provides Jack-Sensing function, S/PDIF Out support, and interrupt capability. The CODEC also includes the Realtek® proprietary UAJ® (Universal Audio Jack) technology for all audio ports, eliminating cable connection errors, and giving users plug and play convenience.

Follow the installation wizard to install the Realtek® Audio Driver from the support DVD that came with the motherboard package.

If the Realtek® audio software is correctly installed, you will find the Realtek® HD Audio Manager icon on the taskbar. Double-Click on the icon to display the Realtek® HD Audio Manager.



Realtek® HD Audio Manager

### Realtek® HD Audio Manager with DTS Studio Sound™ for Windows® 8.1 / Windows® 7



## Selecting an audio output

Realtek HD Audio Manager allows you to select the type of audio output depending on the output device that you are using.

To select an audio output:

1. Insert the audio device's jack to the Line Out (lime) port. If the audio device's jack is already inserted to the corresponding port, Click  on the Realtek HD Audio Manager.
2. On the pop-up window, tick the audio device that you plugged to the Line Out port then Click **Next**.

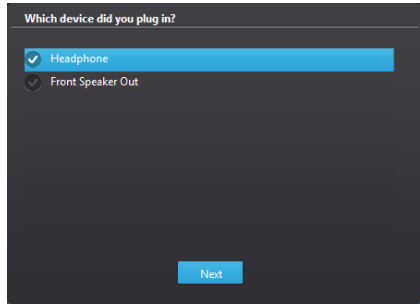

- a. If you select **Headphone**, Click to select the type of headphone installed then Click **OK**.

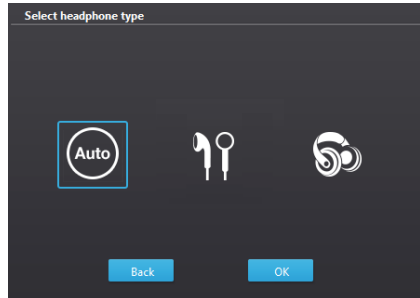

- b. If you select **Front Speaker Out**, Click to select the type of speaker installed then Click **OK**.

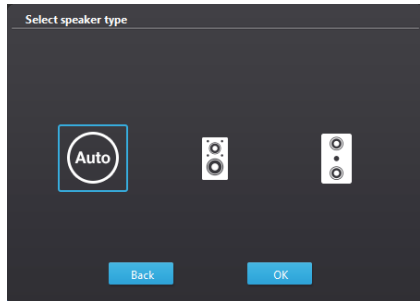



# RAID Support

# 5

## 5.1 RAID configurations

The motherboard supports Intel® Rapid Storage Technology with RAID 0, RAID 1, RAID 10, and RAID 5 solution.



---

If you want to install a Windows® operating system to a hard disk drive included in a RAID set, you have to create a RAID driver disk and load the RAID driver during OS installation. Refer to section 5.2 **Creating a RAID driver disk** for details.

---

### 5.1.1 RAID definitions

**RAID 0 (Data striping)** optimizes two identical hard disk drives to read and write data in parallel, interleaved stacks. Two hard disks perform the same work as a single drive but at a sustained data transfer rate, double that of a single disk alone, thus improving data access and storage. Use of two new identical hard disk drives is required for this setup.

**RAID 1 (Data mirroring)** copies and maintains an identical image of data from one drive to a second drive. If one drive fails, the disk array management software directs all applications to the surviving drive as it contains a complete copy of the data in the other drive. This RAID configuration provides data protection and increases fault tolerance to the entire system. Use two new drives or use an existing drive and a new drive for this setup. The new drive must be of the same size or larger than the existing drive.

**RAID 5** stripes both data and parity information across three or more hard disk drives. Among the advantages of RAID 5 configuration include better HDD performance, fault tolerance, and higher storage capacity. The RAID 5 configuration is best suited for transaction processing, relational database applications, enterprise resource planning, and other business systems. Use a minimum of three identical hard disk drives for this setup.

**RAID 10** is data striping and data mirroring combined without parity (redundancy data) having to be calculated and written. With the RAID 10 configuration you get all the benefits of both RAID 0 and RAID 1 configurations. Use four new hard disk drives or use an existing drive and three new drives for this setup.

## 5.1.2 Installing Serial ATA hard disks

The motherboard supports Serial ATA hard disk drives. For optimal performance, install identical drives of the same model and capacity when creating a disk array.

To install the SATA hard disks for a RAID configuration:

1. Install the SATA hard disks into the drive bays.
2. Connect the SATA signal cables.
3. Connect a SATA power cable to the power connector on each drive.

## 5.1.3 Setting the RAID item in BIOS

You must enable the RAID function in the BIOS Setup before creating RAID sets using SATA HDDs.

To set the RAID item in BIOS:

1. Enter the BIOS Setup during POST.
2. Go to the **Advanced** menu > **SATA Configuration**, then press <Enter>.
3. Set the SATA Mode item to **[RAID Mode]**.
4. Save your changes, and then exit the BIOS Setup.



---

Refer to Chapter 3 for details on entering and navigating through the BIOS Setup

---



---

Due to chipset limitation, when SATA ports are set to RAID mode, all SATA ports run at RAID mode together.

---

## 5.1.4 Intel® Rapid Storage Technology Option ROM utility

To enter the Intel® Rapid Storage Technology Option ROM utility:

1. Turn on the system.
2. During POST, press <Ctrl> + <I> to display the utility main menu.

```

Intel(R) Rapid Storage Technology - Option - v10.5.1.1070
Copyright(C) 2003-14 Intel Corporation. All Rights Reserved.

[ MAIN MENU ]

1. Create RAID Volume          4. Recovery Volume Options
2. Delete RAID Volume         5. Acceleration Options
3. Reset Disks to Non-RAID    6. Exit

[ DISK/VOLUME INFORMATION ]

RAID Volumes:
None defined.

Physical Devices:
Port  Device Model  Serial #      Size   Type/Status (Vol ID)
0     ST3160812AS     9LS0HJA4     149.0GB Non-RAID Disk
1     ST3160812AS     9LS0F4HL     149.0GB Non-RAID Disk
2     ST3160812AS     3LS0JYL8     149.0GB Non-RAID Disk
3     ST3160812AS     9LS0BJ5H     149.0GB Non-RAID Disk

[↑↓]-Select      [ESC]-Exit      [ENTER]-Select Menu

```

The navigation keys at the bottom of the screen allow you to move through the menus and select the menu options.



The RAID BIOS setup screens shown in this section are for reference only and may not exactly match the items on your screen.



The utility supports maximum four hard disk drives for RAID configuration.

## Creating a RAID set

To create a RAID set:

1. From the utility main menu, select **1. Create RAID Volume** and press <Enter>. The following screen appears:

```
Intel(R) Rapid Storage Technology - Option - v10.5.1.1070
Copyright(C) 2003-14 Intel Corporation. All Rights Reserved.

[CREATE VOLUME MENU]
Name: Volume 0
RAID Level:
Disks:
Strip Size:
Capacity:
Sync:
Create volume

[HELP]

Enter a unique volume name that has no special characters
and is 16 characters or less.

[↑↓]-Select [ESC]-Exit [ENTER]-Select Menu
```

2. Enter a name for the RAID set and press <Enter>.
3. When the RAID Level item is selected, press the up/down arrow key to select a RAID level to create, and then press <Enter>.
4. When the Disks item is selected, press <Enter> to select the hard disk drives you want to include in the RAID set. The SELECT DISKS screen appears:

```
[SELECT DISKS]

Port Device Model Serial # Size Status
0 ST3160812AS 9LS0HJA4 149.0GB Non-RAID Disk
1 ST3160812AS 9LS0F4HL 149.0GB Non-RAID Disk
2 ST3160812AS 3LS0JYL8 149.0GB Non-RAID Disk
3 ST3160812AS 9LS0BJ5H 149.0GB Non-RAID Disk

Select 2 to 6 to use in creating the volume.

[↑↓]-Prev/Next [SPACE]-SelectDisk [ENTER]-Done
```

5. Use the up/down arrow key to select a drive, and then press <Space> to select. A small triangle marks the selected drive. Press <Enter> after completing your selection.
6. Use the up/down arrow key to select the stripe size for the RAID array (for RAID 0, 10 and 5 only), then press <Enter>. The available stripe size values range from 4 KB to 128 KB. The following are typical values:
  - RAID 0: 128 KB
  - RAID 10: 64 KB
  - RAID 5: 64 KB



---

We recommend a lower stripe size for server systems, and a higher stripe size for multimedia computer systems used mainly for audio and video editing.

---

7. When the **Capacity** item is selected, enter the RAID volume capacity that you want and press <Enter>. The default value indicates the maximum allowed capacity.
8. When the **Create Volume** item is selected, press <Enter>. The following warning message appears:

```
WARNING: ALL DATA ON SELECTED DISKS WILL BE LOST.  
Are you sure you want to create this volume? (Y/N)
```

9. Press <Y> to create the RAID volume and return to the main menu, or <N> to go back to the **CREATE VOLUME** menu.

## Deleting a RAID set



Be cautious when deleting a RAID set. You will lose all data on the hard disk drives when you delete a RAID set.

To delete a RAID set:

1. From the utility main menu, select **2. Delete RAID Volume** and press <Enter>. The following screen appears:

```
[DELETE VOLUME MENU]
Name      Level      Drives  Capacity  Status  Bootable
Volume0   RAID0 (Stripe)  2       298.0GB  Normal  Yes

[HELP]

Deleting a volume will reset the disks to non-RAID.

WARNING: ALL DISK DATA WILL BE DELETED.
(This does not apply to Recovery volumes)

[↑]-Select [ESC]-Previous Menu [DEL]-Delete Volume
```

2. Use the up/down arrow key to select the RAID set you want to delete, and then press <Delete>. The following warning message appears:

```
[DELETE VOLUME VERIFICATION]

ALL DATA IN THE VOLUME WILL BE LOST!
(This does not apply to Recovery volumes)

Are you sure you want to delete "Volume0"? (Y/N):
```

3. Press <Y> to delete the RAID set and return to the utility main menu, or press <N> to return to the DELETE VOLUME menu.

## Exiting the Intel® Rapid Storage Technology Option ROM utility

To exit the utility:

1. From the utility main menu, select **5. Exit**, then press <Enter>. The following warning message appears:

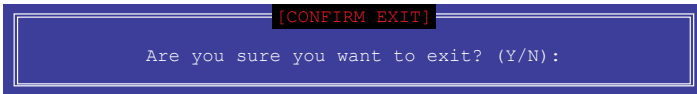

2. Press <Y> to exit or press <N> to return to the utility main menu.

## 5.2 Creating a RAID driver disk

A floppy disk with the RAID driver is required when installing a Windows® operating system on a hard disk drive that is included in a RAID set.



---

The motherboard does not provide a floppy drive connector. You have to use a USB floppy disk drive when creating a SATA RAID driver disk.

---

### 5.2.1 Creating a RAID driver disk without entering the OS

To create a RAID driver disk without entering the OS:

1. Boot your computer.
2. Press <Delete> during POST to enter the BIOS setup utility.
3. Set the optical drive as the primary boot device.
4. Insert the support DVD into the optical drive.
5. Save changes and exit BIOS.
6. When the Make Disk menu appears, press <1> to create a RAID driver disk.
7. Insert a formatted floppy disk into the USB floppy disk drive, then press <Enter>.
8. Follow the succeeding screen instructions to complete the process.

## 5.2.2 Creating a RAID driver disk in Windows®

To create a RAID driver disk in Windows®:

1. Start Windows®.
2. Plug the USB floppy disk drive and insert a floppy disk.
3. Place the motherboard support DVD into the optical drive.
4. Go to the **Intel AHCI/RAID Driver** menu then click **Intel AHCI/RAID Driver path** to open the RAID driver folder.
5. Select **32bit** or **64bit** folder depending on your operating system. Copy the files of the selected folder to the root path of your USB floppy disk drive.



---

Write-protect the floppy disk to avoid a computer virus infection.

---

## 5.2.3 Installing the RAID driver during Windows® OS installation

To install the RAID driver for Windows® 7:

1. During the OS installation, click **Load Driver** to allow you to select the installation media containing the RAID driver.
2. Insert the USB flash drive with RAID driver into the USB port or the support DVD into the optical drive, and then click **Browse**.
3. Click the name of the device you've inserted, go to **Drivers > RAID**, and then select the RAID driver for the corresponding OS version. Click **OK**.
4. Follow the succeeding screen instructions to complete the installation.



---

Before loading the RAID driver from a USB flash drive, you have to use another computer to copy the RAID driver from the support DVD to the USB flash drive.

---



---

To set up a Windows® UEFI operating system under RAID mode, ensure to load the UEFI driver for your optical drive.

---



# Multiple GPU support

## 6.1 AMD® CrossFireX™ technology

The motherboard supports the AMD® CrossFireX™ technology that allows you to install multi-graphics processing units (GPU) graphics cards. Follow the installation procedures in this section.

### 6.1.1 Requirements

- In Dual CrossFireX mode, you should have two identical CrossFireX-ready graphics cards or one CrossFireX-ready dual-GPU graphics card that are AMD® certified.
- Ensure that your graphics card driver supports the AMD CrossFireX technology. Download the latest driver from the AMD website ([www.amd.com](http://www.amd.com)).
- Ensure that your power supply unit (PSU) can provide at least the minimum power required by your system. See Chapter 1 for details.



- 
- We recommend that you install additional chassis fans for better thermal environment.
  - Visit the AMD Game website (<http://game.amd.com>) for the latest certified graphics card and the supported 3D application list.
- 

### 6.1.2 Before you begin

For AMD CrossFireX to work properly, you have to uninstall all existing graphics card drivers before installing AMD CrossFireX graphics cards to your system.

#### To uninstall existing graphics card drivers:

1. Close all current applications.
2. For Windows XP, go to **Control Panel > Add/Remove Programs**.  
For Windows 7, go to **Control Panel > Programs and Features**.
3. Select your current graphics card driver/s.
4. For Windows XP, select **Add/Remove**.  
For Windows 7, select **Uninstall**.
5. Turn off your computer.

## 6.1.3 Installing two CrossFire™ graphics cards



The following pictures are for reference only. The graphics cards and the motherboard layout may vary with models, but the installation steps remain the same.

To install two CrossFire™ graphics cards:

1. Prepare two CrossFireX-ready graphics cards.
2. Insert the two graphics card into the PCIEX16 slots. If your motherboard has more than two PCIEX16 slots, refer to Chapter 1 in this user manual for the locations of the PCIEX16 slots recommended for multi-graphics card installation.
3. Ensure that the cards are properly seated on the slots.
4. Align and firmly insert the CrossFireX bridge connector to the goldfingers on each graphics card. Ensure that the connector is firmly in place.

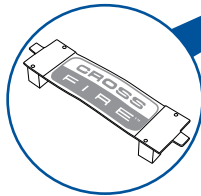
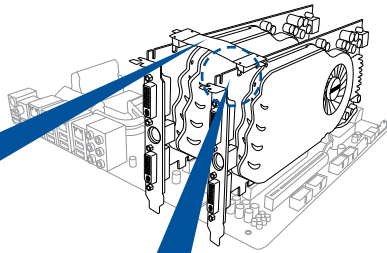
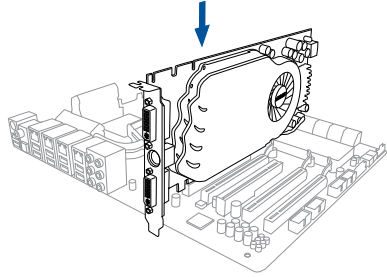

CrossFireX bridge  
(bundled with  
graphics cards)

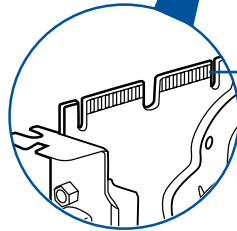

Goldfingers

5. Connect two independent auxiliary power sources from the power supply to the two graphics cards separately.
6. Connect a VGA or a DVI cable to the graphics card.

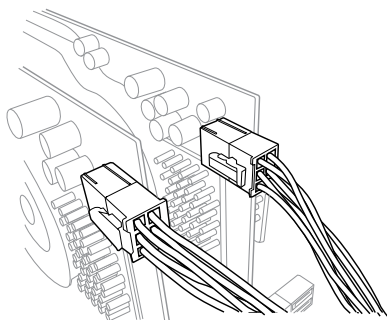

### 6.1.4 Installing three CrossFireX™ graphics cards

To install three CrossFireX™ graphics cards:

1. Prepare three CrossFireX-ready graphics cards.
2. Insert the three graphics card into the PCIEX16 slots. If your motherboard has more than three PCIEX16 slots, refer to Chapter 1 in this user manual for the locations of the PCIEX16 slots recommended for multi-graphics card installation.
3. Ensure that the cards are properly seated on the slots.
4. Align and firmly insert the two CrossFireX™ bridge connectors to the goldfingers on each graphics card. Ensure that the connectors are firmly in place.

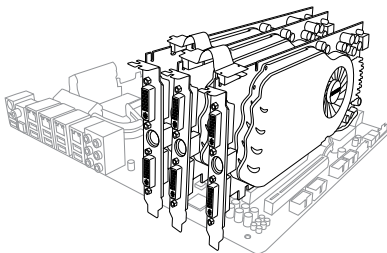

5. Connect three independent auxiliary power sources from the power supply to the three graphics cards separately.
6. Connect a VGA or a DVI cable to the graphics card.

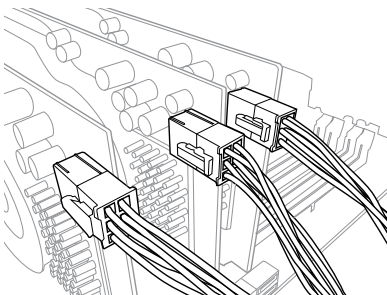

## 6.1.5 Installing four CrossFire™ graphics cards

To install four CrossFire™ graphics cards:

1. Prepare four CrossFireX-ready graphics cards.
2. Insert the four graphics cards into the PCIEX16 slots. Refer to Chapter 1 in this user manual for the locations of the PCIEX16 slots recommended for multi-graphics card installation.
3. Ensure that the cards are properly seated on the slots.
4. Align and firmly insert the three CrossFireX bridge connectors to the goldfingers on each graphics card. Ensure that the connectors are firmly in place.

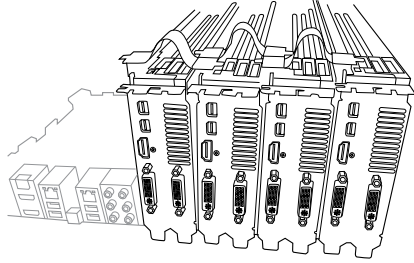

5. Connect four independent auxiliary power sources from the power supply to the four graphics cards separately.
6. Connect a VGA or a DVI cable to the graphics card.

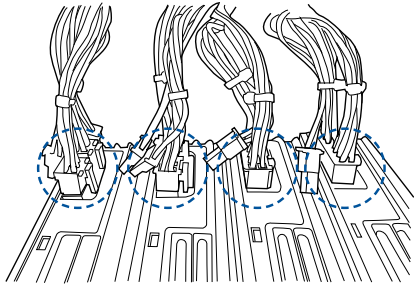

## 6.1.6 Installing the device drivers

Refer to the documentation that came with your graphics card package to install the device drivers.



---

Ensure that your PCI Express graphics card driver supports the AMD® CrossFireX™ technology. Download the latest driver from the AMD website at [www.amd.com](http://www.amd.com).

---

## 6.1.7 Enabling the AMD® CrossFireX™ technology

After installing your graphics cards and the device drivers, enable the CrossFireX™ feature through the AMD Vision Engine Control Center in Windows environment.

### Launching the AMD VISION Engine Control Center

To launch the AMD VISION Engine Control Center:

Right-click on the Windows® desktop and select **AMD VISION Engine Control Center**.

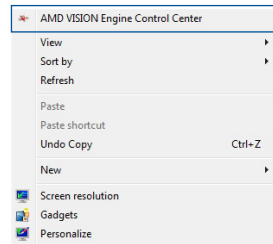

## Enabling Dual CrossFire™ technology

To enable Dual CrossFire™ technology:

1. In the AMD Vision Engine Control Center window, click **Performance > AMD CrossFire™**.
2. Select **Enable CrossFire™**.
3. Select a GPU combination from the drop-down list.
4. Click **Apply** to save and activate the GPU settings made.

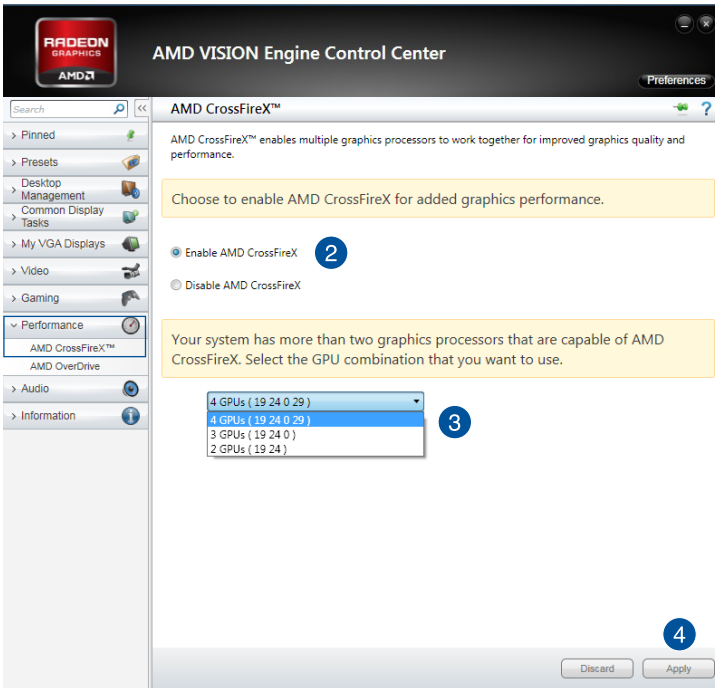

## 6.2 NVIDIA® SLI® technology

The motherboard supports the NVIDIA® SLI® (Scalable Link Interface) technology that allows you to install multi-graphics processing units (GPU) graphics cards. Follow the installation procedures in this section.

### 6.2.1 Requirements

- In SLI mode, you should have two identical SLI-ready graphics cards that are NVIDIA® certified.
- Ensure that your graphics card driver supports the NVIDIA® SLI® technology. Download the latest driver from the NVIDIA® website at [www.nvidia.com](http://www.nvidia.com).
- Ensure that your power supply unit (PSU) can provide at least the minimum power required by your system.



- We recommend that you install additional chassis fans for better thermal environment.
- Visit the NVIDIA® zone website at <http://www.nzone.com> for the latest certified graphics card and supported 3D application list.

### 6.2.2 Installing two SLI-ready graphics cards



The following pictures are for reference only. The graphics cards and the motherboard layout may vary with models, but the installation steps remain the same.

To install two SLI-ready graphics cards:

1. Prepare two SLI-ready graphics cards.
2. Insert the two graphics card into the PCIEX16 slots. If your motherboard has more than two PCIEX16 slots, refer to Chapter 1 in this user manual for the locations of the PCIEX16 slots recommended for multi-graphics card installation.
3. Ensure that the cards are properly seated on the slots.

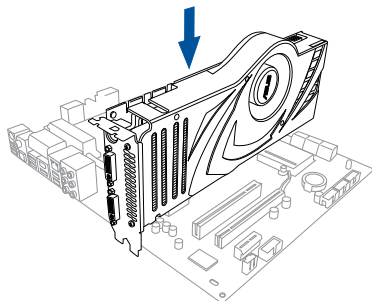

4. Align and firmly insert the SLI bridge connector to the goldfingers on each graphics card. Ensure that the connector is firmly in place.
5. Connect two independent auxiliary power sources from the power supply to the two graphics cards separately.
6. Connect a VGA or a DVI cable to the graphics card.

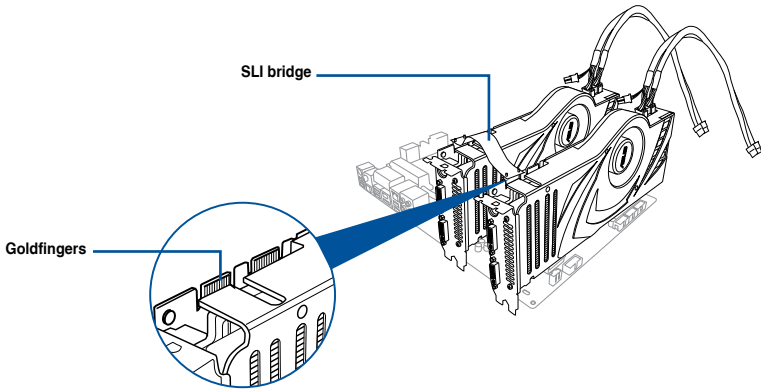

### 6.2.3 Installing three SLI-ready graphics cards

Refer to the documentation that came with your graphics card package to install the device drivers.

To install three SLI-ready graphics cards:

1. Prepare three SLI-ready graphics cards.
2. Insert the three graphics cards into the PCIEX16 slots. If your motherboard has more than two PCIEX16 slots, refer to Chapter 1 in this user manual for locations of the PCIEX16 slots recommended for multi-graphics card installation.
3. Ensure that the cards are properly seated on the slots.

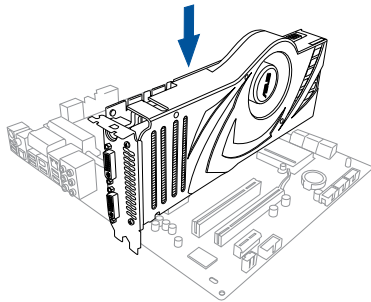



4. Align and firmly insert the 3-way SLI bridge connector to the goldfingers on each graphics card. Ensure that the connector is firmly in place.
5. Connect three independent auxiliary power sources from the power supply to the three graphics cards separately.
6. Connect a VGA or a DVI cable to the graphics card.

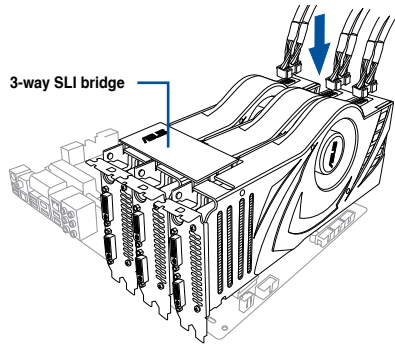

## 6.2.4 Installing four SLI-ready graphics cards

To install four SLI-ready graphics cards:

1. Prepare four SLI-ready graphics cards.
2. Insert the four graphics cards into the PCIEX16 slots. If your motherboard has more than two PCIEX16 slots, refer to Chapter 1 in this user manual for the locations of the PCIEX16 slots recommended for multi-graphics card installation.
3. Ensure that the cards are properly seated on the slots.
4. Align and firmly insert the 4-way SLI bridge connector to the goldfingers on each graphics card. Ensure that the connector is firmly in place.
5. Connect four independent auxiliary power sources from the power supply to the four graphics cards separately.
6. Connect a VGA or a DVI cable to the graphics card.

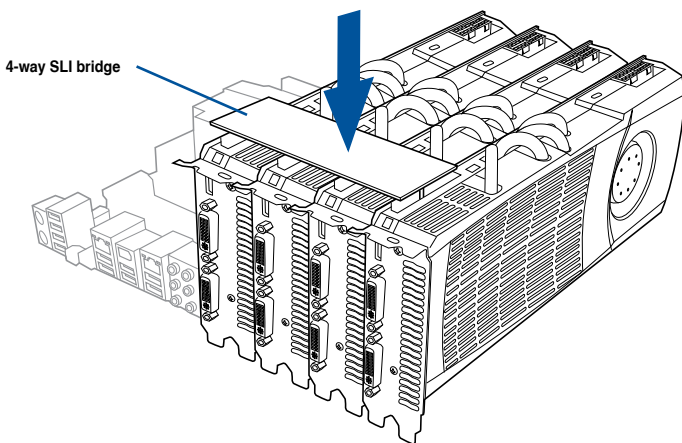

## 6.2.5 Installing the device drivers

Refer to the documentation that came with your graphics card package to install the device drivers.



Ensure that your PCI Express graphics card driver supports the NVIDIA® SLI® technology. Download the latest driver from the NVIDIA® website at [www.nvidia.com](http://www.nvidia.com).

## 6.2.6 Enabling the NVIDIA® SLI® technology

After installing your graphics cards and the device drivers, enable the SLI feature in NVIDIA® Control Panel under the Windows® 7 operating system.

### Launching the NVIDIA Control Panel

You can launch the NVIDIA Control Panel by the following two methods:

- A. Right click on the empty space of the Windows® desktop and select **NVIDIA Control Panel**.

The NVIDIA Control Panel window appears (See Step B3).

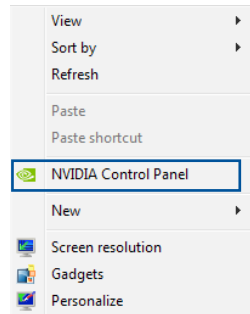

- B1. If you cannot see the NVIDIA Control Panel item in step (A), select **Screen Resolution**.

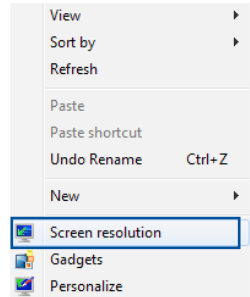

- B2. From the Screen Resolution window, click **Advanced settings**.

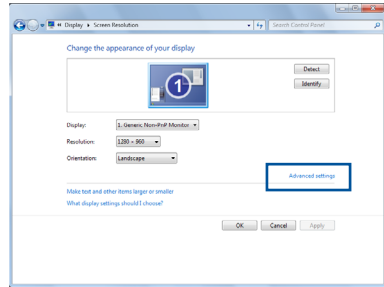

- B3. The NVIDIA Control Panel window appears.

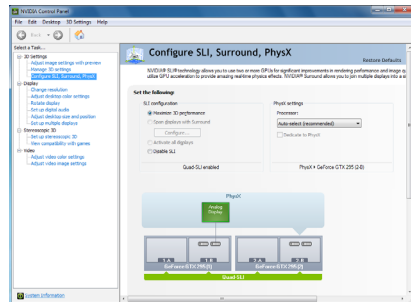

### Enabling SLI settings

From the NVIDIA Control Panel window, select **Configure SLI, Surround, PhysX**. In the **Quad-SLI enabled**, click **Maximize 3D Performance SLI** to set the display for viewing SLI rendered content. When done, click **Apply**.

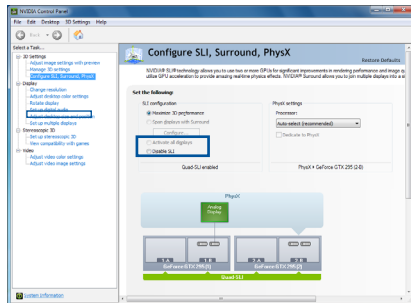



# Appendices

## Z170-WS block diagram

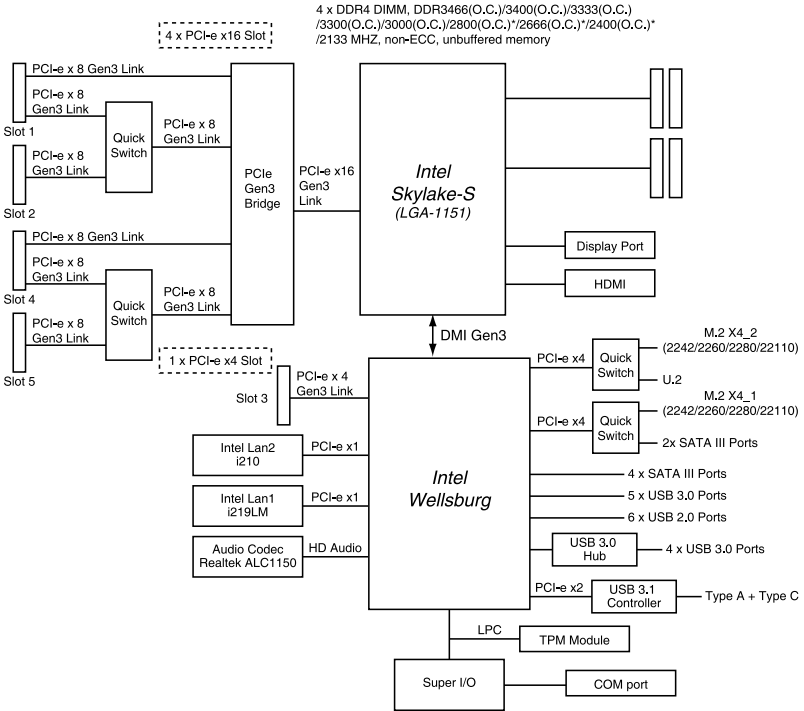

# Notices

## Federal Communications Commission Statement

This device complies with Part 15 of the FCC Rules. Operation is subject to the following two conditions:

- This device may not cause harmful interference.
- This device must accept any interference received including interference that may cause undesired operation.

This equipment has been tested and found to comply with the limits for a Class B digital device, pursuant to Part 15 of the FCC Rules. These limits are designed to provide reasonable protection against harmful interference in a residential installation. This equipment generates, uses and can radiate radio frequency energy and, if not installed and used in accordance with manufacturer's instructions, may cause harmful interference to radio communications. However, there is no guarantee that interference will not occur in a particular installation. If this equipment does cause harmful interference to radio or television reception, which can be determined by turning the equipment off and on, the user is encouraged to try to correct the interference by one or more of the following measures:

- Reorient or relocate the receiving antenna.
- Increase the separation between the equipment and receiver.
- Connect the equipment to an outlet on a circuit different from that to which the receiver is connected.
- Consult the dealer or an experienced radio/TV technician for help.



---

The use of shielded cables for connection of the monitor to the graphics card is required to assure compliance with FCC regulations. Changes or modifications to this unit not expressly approved by the party responsible for compliance could void the user's authority to operate this equipment.

---

## IC: Canadian Compliance Statement

Complies with the Canadian ICES-003 Class B specifications. This device complies with RSS 210 of Industry Canada. This Class B device meets all the requirements of the Canadian interference-causing equipment regulations.

This device complies with Industry Canada license exempt RSS standard(s). Operation is subject to the following two conditions: (1) this device may not cause interference, and (2) this device must accept any interference, including interference that may cause undesired operation of the device.

Cet appareil numérique de la Classe B est conforme à la norme NMB-003 du Canada. Cet appareil numérique de la Classe B respecte toutes les exigences du Règlement sur le matériel brouilleur du Canada.

Cet appareil est conforme aux normes CNR exemptes de licence d'Industrie Canada. Le fonctionnement est soumis aux deux conditions suivantes :

- (1) cet appareil ne doit pas provoquer d'interférences et
- (2) cet appareil doit accepter toute interférence, y compris celles susceptibles de provoquer un fonctionnement non souhaité de l'appareil.

## Canadian Department of Communications Statement

This digital apparatus does not exceed the Class B limits for radio noise emissions from digital apparatus set out in the Radio Interference Regulations of the Canadian Department of Communications.

This class B digital apparatus complies with Canadian ICES-003.

## VCCI: Japan Compliance Statement

### Class B ITE

この装置は、クラスB情報技術装置です。この装置は、家庭環境で使用することを目的としていますが、この装置がラジオやテレビジョン受信機に近接して使用されると、受信障害を引き起こすことがあります。

取扱説明書に従って正しい取り扱いをして下さい。

VCCI-B

## KC: Korea Warning Statement

B급 기기 (가정용 방송통신기자재)

이 기기는 가정용(B급) 전자파적합기기로서 주로 가정에서 사용하는 것을 목적으로 하며, 모든 지역에서 사용할 수 있습니다.

## REACH

Complying with the REACH (Registration, Evaluation, Authorisation, and Restriction of Chemicals) regulatory framework, we published the chemical substances in our products at ASUS REACH website at <http://csr.asus.com/english/REACH.htm>.



DO NOT throw the motherboard in municipal waste. This product has been designed to enable proper reuse of parts and recycling. This symbol of the crossed out wheeled bin indicates that the product (electrical and electronic equipment) should not be placed in municipal waste. Check local regulations for disposal of electronic products.



DO NOT throw the mercury-containing button cell battery in municipal waste. This symbol of the crossed out wheeled bin indicates that the battery should not be placed in municipal waste.

## ASUS Recycling/Takeback Services

ASUS recycling and takeback programs come from our commitment to the highest standards for protecting our environment. We believe in providing solutions for you to be able to responsibly recycle our products, batteries, other components as well as the packaging materials. Please go to <http://csr.asus.com/english/Takeback.htm> for detailed recycling information in different regions.

## Regional notice for California

**WARNING!** This product may contain chemicals known to the State of California to cause cancer, birth defects or other reproductive harm. Wash hands after handling.

## Google™ License Terms

Copyright© 2017 Google Inc. All Rights Reserved.

Licensed under the Apache License, Version 2.0 (the "License"); you may not use this file except in compliance with the License. You may obtain a copy of the License at:

<http://www.apache.org/licenses/LICENSE-2.0>

Unless required by applicable law or agreed to in writing, software distributed under the License is distributed on an "AS IS" BASIS, WITHOUT WARRANTIES OR CONDITIONS OF ANY KIND, either express or implied.

See the License for the specific language governing permissions and limitations under the License.



**English** ASUSTeK Computer Inc. hereby declares that this device is in compliance with the essential requirements and other relevant provisions of related Directives. Full text of EU declaration of conformity is available at: [www.asus.com/support](http://www.asus.com/support)

**Français** ASUSTeK Computer Inc. déclare par la présente que cet appareil est conforme aux critères essentiels et autres clauses pertinentes des directives concernées. La déclaration de conformité de l'UE peut être téléchargée à partir du site Internet suivant : [www.asus.com/support](http://www.asus.com/support).

**Deutsch** ASUSTeK Computer Inc. erklärt hiermit, dass dieses Gerät mit den wesentlichen Anforderungen und anderen relevanten Bestimmungen der zugehörigen Richtlinien übereinstimmt. Der gesamte Text der EU-Konformitätserklärung ist verfügbar unter: [www.asus.com/support](http://www.asus.com/support)

**Italiano** ASUSTeK Computer Inc. con la presente dichiara che questo dispositivo è conforme ai requisiti essenziali e alle altre disposizioni pertinenti con le direttive correlate. Il testo completo della dichiarazione di conformità UE è disponibile all'indirizzo: [www.asus.com/support](http://www.asus.com/support)

**Русский** Компания ASUS заявляет, что это устройство соответствует основным требованиям и другим соответствующим условиям соответствующих директив. Подробную информацию, пожалуйста, смотрите на [www.asus.com/support](http://www.asus.com/support)

**Български** С настоящото ASUSTeK Computer Inc. декларира, че това устройство е в съответствие със съществените изисквания и другите приложими постановления на свързаните директиви. Пълният текст на декларацията за съответствие на ЕС е достъпна на адрес: [www.asus.com/support](http://www.asus.com/support)

**Hrvatski** ASUSTeK Computer Inc. ovim izjavljuje da je ovaj uređaj sukladan s bitnim zahtjevima i ostalim odgovarajućim odredbama vezanih direktiva. Cijeli tekst EU izjave o sukladnosti dostupan je na: [www.asus.com/support](http://www.asus.com/support)

**Čeština** Společnost ASUSTeK Computer Inc. tímto prohlašuje, že toto zařízení splňuje základní požadavky a další příslušná ustanovení souvisejících směrnic. Plné znění prohlášení o shodě EU je k dispozici na adrese: [www.asus.com/support](http://www.asus.com/support)

**Dansk** ASUSTeK Computer Inc. erklærer hermed, at denne enhed er i overensstemmelse med hovedkravene og andre relevante bestemmelser i de relaterede direktiver. Hele EU-overensstemmelseserklæringen kan findes på: [www.asus.com/support](http://www.asus.com/support)

**Nederlands** ASUSTeK Computer Inc. verklaart hierbij dat dit apparaat voldoet aan de essentiële vereisten en andere relevante bepalingen van de verwante richtlijnen. De volledige tekst van de EU-verklaring van conformiteit is beschikbaar op: [www.asus.com/support](http://www.asus.com/support)

**Eesti** Käesolevaga kinnitab ASUSTeK Computer Inc, et see seade vastab asjakohaste direktiivide olulistele nõuetele ja teisteles asjassepuutuvatele sätetele. EL vastavusdeklaratsiooni täielik tekst on saadaval järgmisel aadressil: [www.asus.com/support](http://www.asus.com/support)

**Suomi** ASUSTeK Computer Inc. ilmoittaa täten, että tämä laite on asiaankuuluvien direktiivien olennaisten vaatimusten ja muiden tätä koskevien säädösten mukainen. EU-yhdenmukaisuusilmoituksen koko teksti on luettavissa osoitteessa: [www.asus.com/support](http://www.asus.com/support)

**Ελληνικά** Με το παρόν, η ASUSTeK Computer Inc. δηλώνει ότι αυτή η συσκευή συμμορφώνεται με τις θεμελιώδεις απαιτήσεις και άλλες σχετικές διατάξεις των Οδηγιών της ΕΕ. Το πλήρες κείμενο της δήλωσης συμμορφότητας είναι διαθέσιμο στη διεύθυνση: [www.asus.com/support](http://www.asus.com/support)

**Magyar** Az ASUSTeK Computer Inc. ezennel kijelenti, hogy ez az eszköz megfelel a kapcsolódó irányelvek lényeges követelményeinek és egyéb vonatkozó rendelkezéseinek. Az EU megfelelési nyilatkozat teljes szövege innen letölthető: [www.asus.com/support](http://www.asus.com/support)

**Latviski** ASUSTeK Computer Inc. ar šo paziņo, ka šī ierīce atbilst saistīto Direktīvu būtiskajām prasībām un citiem citiem saistošajiem nosacījumiem. Pilns ES atbilstības paziņojuma teksts pieejams šeit: [www.asus.com/support](http://www.asus.com/support)

**Lietuviu** „ASUSTeK Computer Inc.“ šiuo tvirtina, kad šis įrenginys atitinka pagrindinius reikalavimus ir kitas svarbias susijusių direktyvų nuostatas. Visą ES atitikties deklaracijos tekstą galima rasti: [www.asus.com/support](http://www.asus.com/support)

**Norsk** ASUSTeK Computer Inc. erklærer herved at denne enheten er i samsvar med hovedsaklige krav og andre relevante forskrifter i relaterete direktiver. Fullstendig tekst for EU-samsvarserklæringen finnes på: [www.asus.com/support](http://www.asus.com/support)

**Polski** Firma ASUSTeK Computer Inc. niniejszym oświadcza, że urządzenie to jest zgodne z zasadniczymi wymogami i innymi właściwymi postanowieniami powiązanych dyrektyw. Pełny tekst deklaracji zgodności UE jest dostępny pod adresem: [www.asus.com/support](http://www.asus.com/support)

**Português** A ASUSTeK Computer Inc. declara que este dispositivo está em conformidade com os requisitos essenciais e outras disposições relevantes das Diretivas relacionadas. Texto integral da declaração da UE disponível em: [www.asus.com/support](http://www.asus.com/support)

**Română** ASUSTeK Computer Inc. declară că acest dispozitiv se conformează cerințelor esențiale și altor prevederi relevante ale directivelor conexe. Textul complet al declarației de conformitate a Uniunii Europene se găsește la: [www.asus.com/support](http://www.asus.com/support)

**Srpski** ASUSTeK Computer Inc. ovim izjavljuje da je ovaj uređaj u saglasnosti sa osnovnim zahtevima i drugim relevantnim odredbama povezanih Direktiva. Pun tekst EU deklaracije o usaglasnosti je dostupan da adresi: [www.asus.com/support](http://www.asus.com/support)

**Slovensky** Spoločnosť ASUSTeK Computer Inc. týmto vyhlasuje, že toto zariadenie vyhovuje základným požiadavkám a ostatým príslušným ustanoveniam príslušných smerníc. Celý text vyhlásenia o zhode pre štáty EÚ je dostupný na adrese: [www.asus.com/support](http://www.asus.com/support)

**Slovenščina** ASUSTeK Computer Inc. izjavlja, da je ta naprava skladna z bistvenimi zahtevami in drugimi ustreznimi določbami povezanih direktiv. Celotno besedilo EU-izjave o skladnosti je na voljo na spletnem mestu: [www.asus.com/support](http://www.asus.com/support)

**Español** Por la presente, ASUSTeK Computer Inc. declara que este dispositivo cumple los requisitos básicos y otras disposiciones pertinentes de las directivas relacionadas. El texto completo de la declaración de la UE de conformidad está disponible en: [www.asus.com/support](http://www.asus.com/support)

**Svenska** ASUSTeK Computer Inc. förklarar härmed att denna enhet överensstämmer med de grundläggande kraven och andra relevanta föreskrifter i relaterade direktiv. Fulltext av EU-försäkran om överensstämmelse finns på: [www.asus.com/support](http://www.asus.com/support)

**Українська** ASUSTeK Computer Inc. заявляє, що цей пристрій відповідає основним вимогам та іншим відповідним положенням відповідних Директив. Повний текст декларації відповідності стандартам ЄС доступний на: [www.asus.com/support](http://www.asus.com/support)

**Türkçe** ASUSTeK Computer Inc., bu aygıtın temel gereksinimlerle ve ilişkin Yönergelelerin diğer ilgili koşullarına uyumlu olduğunu beyan eder. AB uygunluk bildirimini tam metni şu adreste bulabilirsiniz: [www.asus.com/support](http://www.asus.com/support)

**Bosanski** ASUSTeK Computer Inc. ovim izjavljuje da je ovaj uređaj uskladen sa bitnim zahtjevima i ostalim odgovarajućim odredbama vezanih direktiva. Cijeli tekst EU izjave o uskladenosti dostupan je na: [www.asus.com/support](http://www.asus.com/support)

## ASUS contact information

### ASUSTeK COMPUTER INC.

Address 4F, No. 150, Li-Te Road, Peitou, Taipei 112, Taiwan  
Telephone +886-2-2894-3447  
Fax +886-2-2890-7798  
Web site [www.asus.com](http://www.asus.com)

#### *Technical Support*

Telephone +86-21-38429911  
Fax +86-21-5866-8722, ext. 9101#  
Online support <http://qr.asus.com/techserv>

### ASUS COMPUTER INTERNATIONAL (America)

Address 800 Corporate Way, Fremont, CA 94539, USA  
Telephone +1-510-739-3777  
Fax +1-510-608-4555  
Web site <http://www.asus.com/us/>

#### *Technical Support*

Support fax +1-812-284-0883  
Telephone +1-812-282-2787  
Online support <http://qr.asus.com/techserv>

### ASUS COMPUTER GmbH (Germany and Austria)

Address Harkort Str. 21-23, 40880 Ratingen, Germany  
Fax +49-2102-959931  
Web site <http://www.asus.com/de>  
Online contact <http://eu-rma.asus.com/sales>

#### *Technical Support*

Telephone +49-2102-5789555  
Support Fax +49-2102-959911  
Online support <http://qr.asus.com/techserv>

# DECLARATION OF CONFORMITY

Per FCC Part 2 Section 2. 1077(a)



**Responsible Party Name:** **Asus Computer International**

**Address:** **800 Corporate Way, Fremont, CA 94539.**

**Phone/Fax No:** **(510)739-3777/(510)608-4555**

hereby declares that the product

**Product Name :** **Motherboard**

**Model Number :** **Z170-WS**

Conforms to the following specifications:

FCC Part 15, Subpart B, Unintentional Radiators

## Supplementary Information:

This device complies with part 15 of the FCC Rules. Operation is subject to the following two conditions: (1) This device may not cause harmful interference, and (2) this device must accept any interference received, including interference that may cause undesired operation.

Representative Person's Name : Steve Chang / President

A handwritten signature in blue ink that reads "Steve Chang".

Signature :

Date : Sep. 04, 2015

Ver. 140331

