



主板中文使用手册

iGame Z370-X RNG Edition V20

www.colorful.cn

技术服务热线：400-678-5866

版本：1.0

目录

第一章 简介	1
1-1 主板特色	1
1-2 主板规格	1
1-3 主板布局图	3
1-4 introduction	5
第二章 硬件安装	9
2-1 基本硬件安装	9
2-2 按钮设置	13
2-3 连接器和引脚接头	15
2-4 背板接口介绍	20
2-5 Hardware Installation	21
第三章 驱动程序安装说明	35
第四章 BIOS 设置	36
4-1 进入 BIOS 主界面	36
4-2 BIOS 主界面	38
4-3 系统信息 (Main)	39
4-4 高级 BIOS 设置 (Advanced)	40
4-5 芯片组设置 (Chipset)	44
4-6 超频设置 (C.Oclock)	45
4-7 安全设置 (Security)	48
4-8 启动设置 (Boot)	49
4-9 退出设置 (Exit)	50
4-10 BIOS Setting	50



根据中华人民共和国信息产业部发布的《电子信息产品污

染控制管理办法》所展开的 SJ/T11364-2006 标准要求, 本产品污染控制标识以及有毒有害物质或元素标识说明如下:

产品有毒有害物质或元素标识:

产品中有毒有害物质或元素的名称及含量

部件名称	有毒有害物质或元素					
	铅(Pb)	汞(Hg)	镉(Cd)	六价铬 (Cr(VI))	多溴联苯 (PBB)	多溴二苯醚 (PBDE)
PCB 板	×	○	○	○	○	○
结构件	○	○	○	○	○	○
芯片	○	○	○	○	○	○
连接器	○	○	○	○	○	○
被动电子元件	○	○	○	○	○	○
焊接金属	○	○	○	○	○	○
线材	×	○	○	○	○	○
助焊剂,散热膏, 标签以及其他耗 材	○	○	○	○	○	○

○: 表示该有毒有害物质在该部件所有均质材料中的含量均在 SJ/T11363-2006 标准规定的限量要求以下。
×: 表示该有毒有害物质至少在该部件的某一均质材料中的含量超出 SJ/T11363-2006 标准规定的限量要求。
备注: ×位置的铅的含量超出 SJ/T11363-2006 标准规定的限量要求, 但符合欧盟 RoHS 指令的豁免条款。

版权

本手册版权属于世和资讯公司所有，未经本公司书面许可，任何人不得对此说明书和其中所包含的任何资料进行复制、拷贝或翻译成其它语言。

声明

本用户手册没有任何形式的担保、立场表达或其它暗示。若有任何因本用户手册或其所提到之产品的所有信息，所引起直接或间接的数据流失、利益损失或事业终止，七彩虹及其所属员工恕不为其担负任何责任。除此之外，本用户手册所提到的产品规格及信息仅供参考，内容亦会随时升级，恕不另行通知。本用户手册的所有部分，包括硬件及软体，若有任何错误，七彩虹没有义务为其担负任何责任。

商标版权

本手册使用的所有商标均属于该商标的持有者所有。

AMD, Athlon , Athlon XP, Thoroughbred 和 Duron™ 是 Advanced Micro Devices 的注册商标。

Intel® 和 Pentium® 是 Intel Corporation 的注册商标。

PS/2 和 OS® 2 是 International Business Machines Corporation 的注册商标。

Windows® 95/98/2000/NT/XP/Vista 是 Microsoft Corporation 的注册商标。

Netware® 是 Novell, Inc 的注册商标。

Award® 是 Phoenix Technologies Ltd 的注册商标。

AMI® 是 American Megatrends Inc 的注册商标。

Kensington 和 MicroSaver 是 Kensington Technology Group 的注册商标。

PCMCIA 和 CardBus 是 Personal Computer Memory Card International Association 的注册商标。

其他在本说明书中使用的产品名称是他们各自所属公司所拥有和被公认的。

技术支持

如果您的系统出现问题，并且无法从本主板使用手册中获得帮助，请联系您所购买主板的经销商。此外您还可以尝试通过以下方式获得帮助：

访问七彩虹的官方网站(<http://www.colorful.cn/>)获取产品和驱动程序等信息支持, 还可以登录七彩虹官方论坛(<http://bbs.colorful.cn/>), 获取技术指导。

通过拨打 400-678-5866 客户服务热线进行咨询, 此外还可以直接与七彩虹各属地平台服务中心联系, 具体联系方式如下:

七彩虹科技全国区域售后服务平台业务范围及联系方式		
平台名称	服务范围	联系方式
北京服务平台	北京、天津、河北、河南、 山东、山西、内蒙古	010—51261907
沈阳服务平台	辽宁、吉林、黑龙江	024—31321755
武汉服务平台	湖北、湖南、江西	027—87865811
南京服务平台	江苏、安徽、浙江	025—83611912
上海服务平台	上海	021—64681880
广州服务平台	广东、广西、福建、海南	020—85276624
成都服务平台	四川、重庆、云南、贵州、西藏	028—85240735
西安服务平台	陕西、甘肃、宁夏、青海、新疆	029—87895086
深圳服务平台	深圳地区	0755—33083060
注意: 以上电话如有变动, 请拨打 400-678-5866 服务热线查询。		

世和资讯公司对本手册拥有最终解释权

在您开始之前

主板包装盒内附标准组件

在您打开本主板包装盒之后，请马上检查下面所列出的各项标准配件是否齐全。

- 1 块 iGame Z370-X RNG Edition V20 主板
- 6 条 SATA 数据线
- 1 张驱动光盘
- 1 片后置面板 IO 挡板
- 1 本主板中英文使用手册



注意:以上配件仅供参考, 请以实物为准, 七彩虹科技保留修改的权利。



Note: 若以上列出的任何一项配件有损坏的情形, 请尽快与您的经销商联络或致电七彩虹客服。

注意: 产品规格/CPU 支持/产品附件以产品发布之时为准。

第一章 简介

感谢您购买七彩虹主板，该主板提供了非常卓越的性能和品质保证。

1-1 主板特色

iGame Z370-X RNG Edition V20主板采用 Intel Z370 芯片组,支持 Intel LGA1151 Coffee Lake 系列处理器,支持双通道 DDR4-3200 (OC) /3000 (OC) /2933 (OC) /2800(OC)/2666(OC)/2600(OC) /2400/2133MHz 规格内存,支持 PCI-E3.0规范。

主板提供 4 个 DDR4 内存条插槽、1 组 HDMI+DP+SPDIF 接口、6 个 SATA3.0 接口、板载 Realtek ALC1150 8 声道声卡、集成 Killer E2500 千兆网卡,性能强劲,是性价比的终极选择!

主板提供 3 个 PCI Express3.0x1 插槽、3 个 PCI Express3.0x16 插槽、2 个 M.2 插槽,扩展模式丰富,扩展性能强劲。

1-2 主板规格

- 设计
 - ATX 板型规范
- 芯片组
 - 主板采用 Intel Z370 高速芯片组
- 中央处理器
 - 支持 Intel LGA1151 Coffee Lake 系列处理器
- 内存
 - 提供 4 个内存条插槽
 - 支持双通道 DDR4-3200 (OC) /3000 (OC) /2933 (OC) /2800 (OC) /2666 (OC) /2600 (OC) /2400/2133MHz 规格内存 (超频的最高频率视内存型号而定)
- 扩展插槽
 - 3 个 PCI Express 3.0x1 插槽
 - 3 个 PCI Express 3.0x16 插槽
 - 2 个 M.2 插槽

- ❑ 存储设备
 - 主板提供 6 个 SATA3.0 6Gb/s 硬盘接口
- ❑ 8 声道音频设备
 - 整合 Realtek ALC1150 8 声道高清晰数字音频控制器
 - 支持 8 声道 3D 环绕声效
- ❑ 网络功能
 - 主板采用 Killer E2500 千兆网卡
 - 支持 10/100/1000Mbps 数据传输率
- ❑ USB 接口
 - 主板提供 7 个 USB2.0、2 个 USB3.1 接口和 6 个 USB3.0 接口（含扩展）
 - 温馨提示: 主板前置 USB3.0 插针（PCB 板上丝印为“USB3F”），扩展后可支持关机充电和快速充电！
- ❑ 板载连接头/跳线/按钮
 - 1 个前置音频接口连接头（F_AUDIO）
 - 1 个前面板开关机和指示灯连接头（F_PANEL）
 - 2 个 USB2.0 接口扩展连接头（F_USB1,F_USB2）
 - 1 个 USB3.0 接口扩展连接头（USB3F）
 - 2 个 CPU 风扇插座（CPUFAN1, CPUFAN2）
 - 3 个辅助风扇插座（SYSFAN1, SYSFAN2,PWR_FAN）
 - 1 个喇叭连接头（BZ）
 - 1 个诊断卡连接头（CASE）
 - 1 个双 BIOS 切换开关（SPIROM_SW）
 - 1 个开关机按钮（POWER）
 - 1 个重启按钮（RESET）
 - 1 个自动超频按钮（QUICK_OC）
 - 1 个一键更新 BIOS 按钮（BIOS_UPDATE）
 - 1 个自动进入 BIOS 界面按钮（BIOS_SET）
 - 1 个板载数码卡显示功能切换按钮（80P_SW）
 - 2 个机箱风扇 RGB 灯连接头（LED_3, LED_4）

1-3 主板布局图

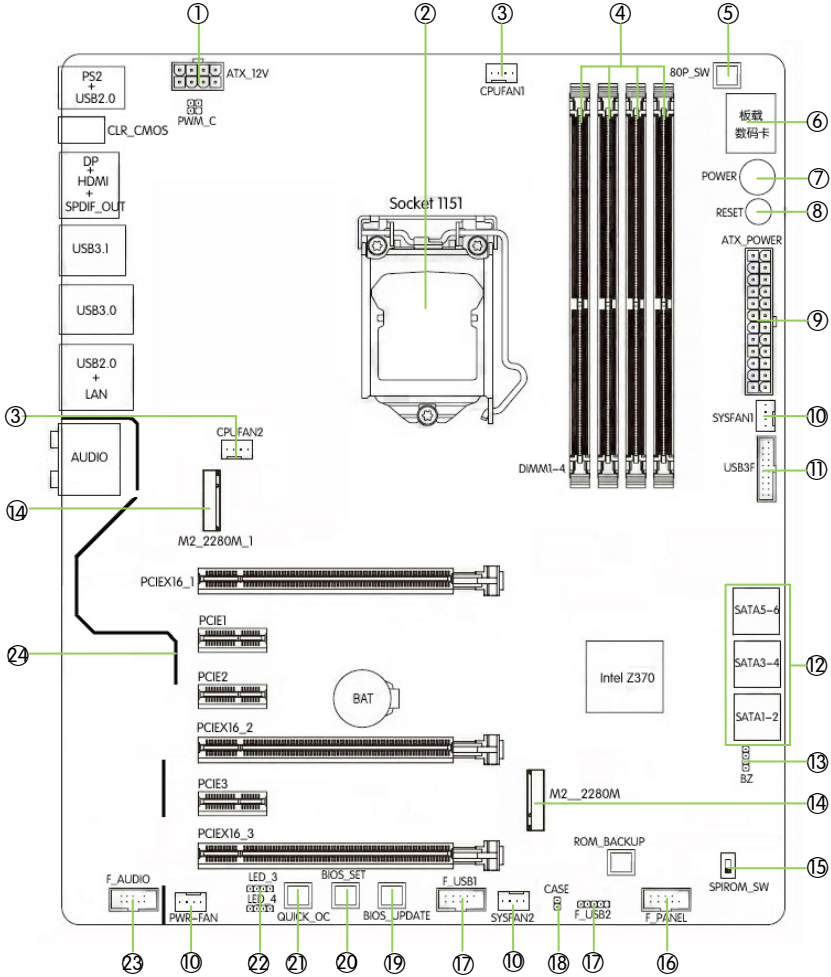

(仅供参考)

主板布局图介绍:	
1、8P 12V 电源插座	2、LGA1151 处理器插槽
3、CPU 风扇插座	4、DDR4 内存条插槽
5、板载数码卡显示功能切换按钮	6、板载数码卡
7、开关机按钮	8、重启按钮
9、24P 电源插座	10、辅助风扇插座
11、USB3.0 接口扩展连接头	12、SATA3.0 6Gb/s 硬盘插座
13、喇叭插针	14、M.2 插槽
15、双 BIOS 切换开关	16、前面板开关机/重启/指示灯插针
17、USB2.0 接口扩展连接头	18、诊断卡连接头
19、一键更新 BIOS 按钮	20、自动进入 BIOS 界面按钮
21、自动超频按钮	22、机箱风扇 RGB 灯连接头
23、前置音频插针	24、主板音频分割区灯带

1-4 introduction

Motherboard features

iGame Z370-X RNG Edition V20 motherboard based on Intel Z370 chipset, support Intel LGA1151 Coffee Lake processors, support dual channel DDR4 -3200 (OC) /3000(OC) /2933(OC) /2800(OC) /2666(OC) /2600(OC) /2400/2133MHz memory, support PCI-E3.0.

The motherboard has 4*DDR4 memory slots、1*HDMI+DP+SPDIF port、6*SATA3.0、7*USB2.0、2*USB3.1 ports and 6*USB3.0(including headers)、onboard Realtek ALC1150 8-ch audio chipset、onboard Killer E2500 1000M LAN, This motherboard is for the high-end user and gaming user!

The motherboard has 3*PCI Express3.0x1 slots、3*PCI Express3.0x16 slots、2*M.2 slots.

Motherboard specifications

- ❑ Form factor
 - ATX
- ❑ Chipset
 - Intel Z370
- ❑ CPU
 - support Intel LGA1151 processors
- ❑ Memory
 - Offer 4 DIMM slots
 - Support dual channel DDR4-3200 (OC) /3000 (OC) /2933 (OC) /2800 (OC) /2666 (OC) /2600 (OC) /2400/2133MHz memory
- ❑ Slots
 - 3*PCI Express 3.0x1 slots
 - 3*PCI Express 3.0x16 slots
 - 2*M.2 slots
- ❑ Storage
 - 6*SATA3.0 6Gb/s ports
- ❑ 8-CH audio devices
 - Onboard Realtek ALC1150 8-ch audio chipset

- ❑ LAN
 - Onboard Killer E2500 1000M LAN
 - Provides 10/100/1000Mb Ethernet
- ❑ USB ports
 - 7*USB2.0、6*USB3.0 and 2*USB3.1 ports
 - The USB3.0 header(the silk–screen on the motherboard PCB board is “USB3F”) support power–off charge and fast charge!
- ❑ Onboard header/jumper/button
 - 1*9–pin Front panel audio connector(F_AUDIO)
 - 1*System Panel connector(F_PANEL)
 - 2*USB2.0 header (F_USB1,F_USB2)
 - 1*USB3.0 header (USB3F)
 - 2*CPU FAN (CPUFAN1, CPUFAN2)
 - 3*System FANS (SYSFAN1, SYSFAN2,PWR_FAN)
 - 1*PC speaker connector (BZ)
 - 1*Debug header (CASE)
 - 1*dual BIOS switch button (SPIROM_SW)
 - 1*power on/power off button (POWER)
 - 1*reset button (RESET)
 - 1*auto over–clocking button (QUICK_OC)
 - 1*one–key update BIOS button (BIOS_UPDATE)
 - 1*auto enter BIOS interface button (BIOS_SET)
 - 1*onboard debug card display function switch button (80P_SW)
 - 2*case fan RGB LED light header(LED_3,LED_4)

Motherboard layout

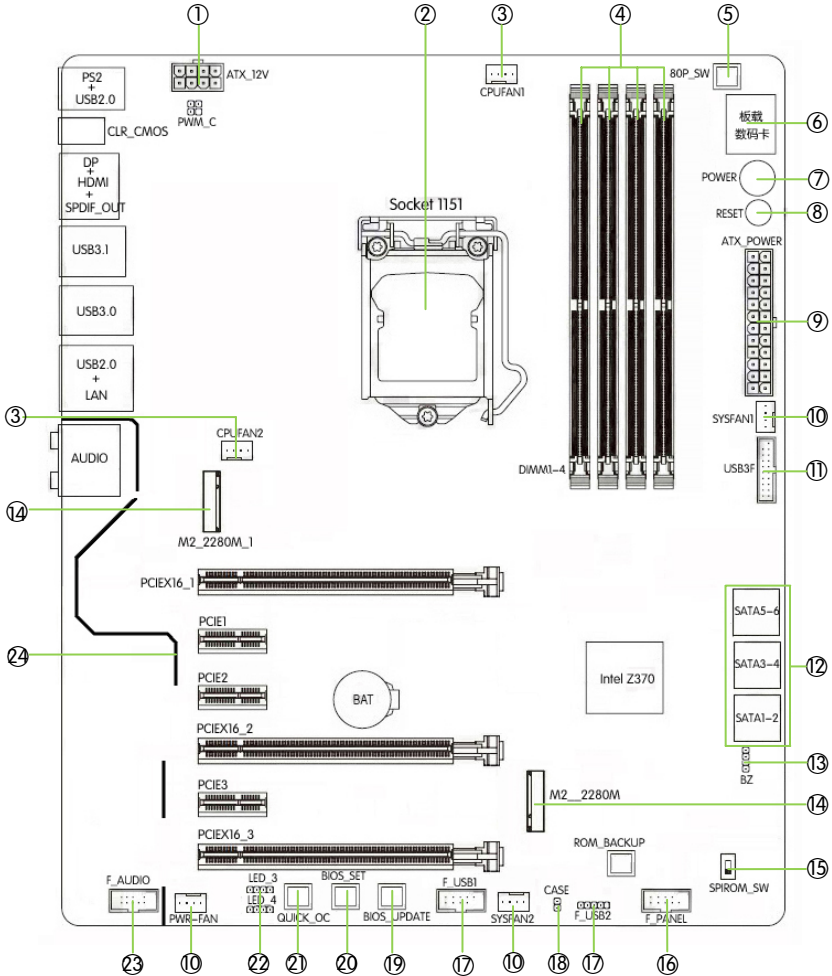

(This is for your reference only)

Motherboard layout introduction :	
1、 8P ATX 12V Power connector	2、 LGA 1151 socket
3、 CPU FAN header	4、 DIMM4 slots
5、 Onboard debug card display function switch button	6、 Onboard debug card
7、 Power on/power off button	8、 Reset button
9、 24–pin ATX Power connector	10、 System FAN Connector
11、 Connect to USB3.0 devices	12、 SATA3.0 6Gb/s ports
13、 Speaker connector	14、 M.2 port
15、 Dual BIOS switch button	16、 Front panel connector
17、 USB 1.1/2.0 port	18、 Debug card header
19、 One–key update BIOS button	20、 Auto enter BIOS interface button
21、 Auto over–clocking button	22、 case fan RGB LED light header
23、 Front panel audio connector	24、 Audio isolated LED light

第二章 硬件安装

请参照以下步骤，完成电脑的安装：

- ❑ 安装中央处理器（CPU）
- ❑ 安装内存
- ❑ 装入机箱
- ❑ 安装所有扩展卡
- ❑ 连接所有讯号线、排线、电源线及面板控制线

2-1 基本硬件安装

安装中央处理器和风扇

本主板具备一个 Socket 1151 处理器插槽，本插槽是专为 Intel LGA1151 接口处理器所设计。请依照以下步骤安装处理器和风扇：

- ❑ 1. 找到位于主板上的处理器插槽，将 CPU 插座旁的锁定杆从锁定状态拨到未锁定状态。
- ❑ 2. 安装 CPU，将 CPU 的金色三角形标示对准主板 CPU 插槽上的三角形标示，确定针角 1 的方向正确，不要用力插 CPU，确信 CPU 完全插入插槽中，将锁定杆从未锁定状态拨到锁定状态。（这一过程非常重要，如果操作不当，有可能会损坏 CPU，所以最好请专业人士代劳。）
- ❑ 3. 安装 CPU 风扇，并将 CPU 风扇电源线连接上。请注意，一定要安装 CPU 风扇，否则可能会温度过高从而损坏 CPU，建议用户使用原装风扇。

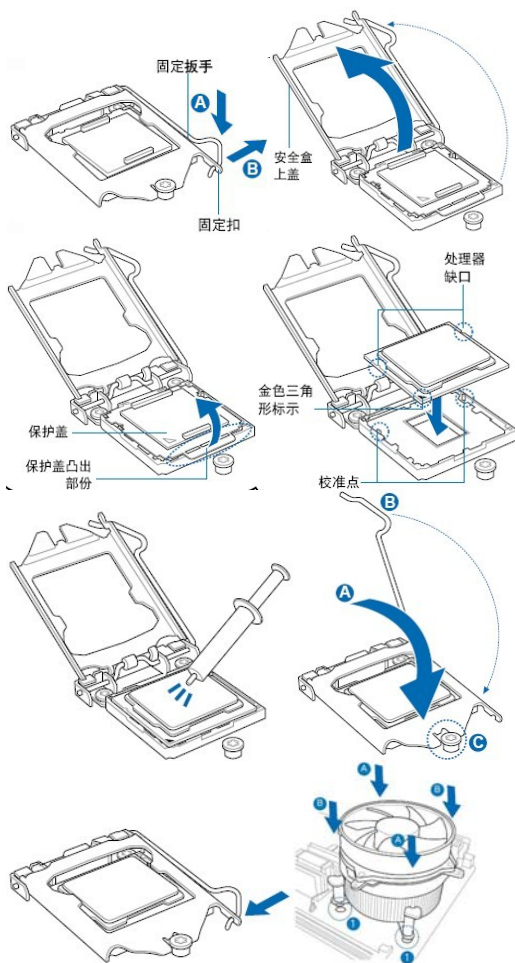

安装内存

主板提供 4 个 DDR4 内存条插槽。下图所示为 DDR4 内存条插槽在主板上的位置。

- ❑ 一条内存: 你可以插入到任何一个内存条插槽。
- ❑ 两条内存: 插入到 DIMM1 和 DIMM3 插槽, 或 DIMM2 和 DIMM4 插槽, 以组建双通道。
- ❑ 三条内存: 不要安插 3 条内存, 可能会引起故障。
- ❑ 四条内存: 插入到 DIMM1、DIMM2、DIMM3、DIMM4 插槽。



CAUTION: 1. 请选择使用相同的内存模组安装到双通道。2. 如果您正确插入了内存模组, 您将不会看到金手指部分。

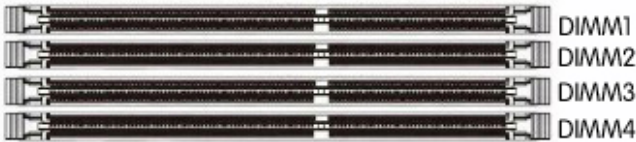

安装显卡

主板提供 3 个 PCI Express 3.0x16 插槽, 用于安装显卡。安装时, 将显卡垂直压入插槽中, 直到其牢固固定于插槽中为止。

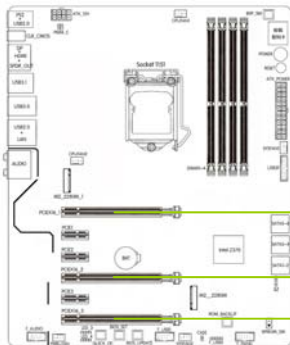

PCIExpress3.0x16 插槽, 支持x16 运行规格 (PCIEX16)。为发挥显卡最大性能, 安装一张显卡时请安装至此插槽。

PCI Express3.0x16插槽, 支持x8运行规格(PCIEX8)。由于PCIEX8插槽与PCIEX16插槽共享频宽, 所以当PCIEX8插槽安装显卡时, PCIEX16插槽最高以x8频宽运行。

PCI Express3.0x16插槽, 支持x4运行规格(PCIEX4)。由于PCIEX4插槽与PCIEX8及PCIEX16插槽共享频宽, 所以当PCIEX4插槽安装显卡时, PCIEX16插槽最高以x8频宽运行, PCIEX8插槽最高以x4频宽运行。

构建 AMD CrossFire™/NVIDIA® SLI™系统

1、主板提供3个PCI Express3.0 x16插槽，支持3-Way/2-Way AMD CrossFire™ 及 2-Way NVIDIA® SLI™ 技术。请参照下列方法构建AMD CrossFire /NVIDIA® SLI™ 系统。

- 系统需求
- 操作系统 Windows10/8.1/8/7
- 具备相同品牌、相同型号且支持 CrossFire/SLI 功能的显卡及其驱动程序
- 电力足够的电源供应器

2、连接显卡

- 将显卡分别安装至主板上的 PCI Express x16 插槽。（注：若要构建 2-Way 系统，请将显卡安装在 PCIEX16 及 PCIEX8 插槽）
- 将 CrossFire /SLI 连接器两端的插槽分别插入显卡上缘的金手指部份。
- 将显示器的接口接至安装于 PCIEX16 插槽上的显卡。

3、设定显卡驱动程序

- 在操作系统中安装完显卡的驱动程序后，请启动 CrossFire/SLI 设定。
- 启动 CrossFire 设定：进入「AMD Catalyst Control Center」。浏览至「性能\AMD CrossFire」画面，确认「启用 CrossFireX」已被选取。再选择您要使用的 GPU 组合。
- 启动 SLI 设定：进入「NVIDIA 控制面板」画面。请浏览至「设定 SLI、环场音频、PhysX」画面，并确认已启用「最大化 3D 性能」。





CAUTION: 启动 CrossFire/SLI 技术的步骤，可能会因不同显卡及驱动程序版本而异，详细信息请参考显卡使用手册的说明。

2-2 按钮设置

双 BIOS 切换器: SPIROM_SW

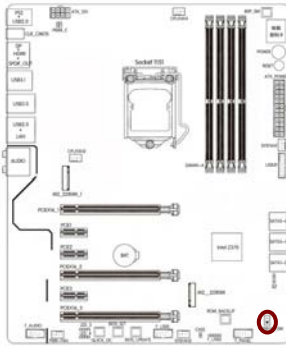
主板提供 1 个双 BIOS 切换器，用于切换 SPIROM_A 和 SPIROM_B。



	SPIROM_B
	SPIROM_A

自动超频按钮: QUICK_OC

主板提供一个 CPU 自动超频按钮，系统下按此键，并重新启动计算机，CPU 将自动超频。有了该旋钮，超频 DIY 更加智能化!

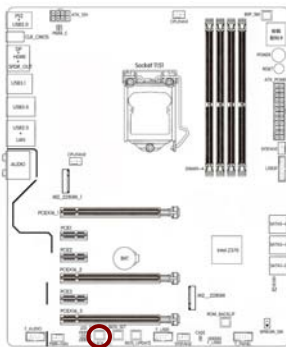

自动进入 BIOS 界面按钮：BIOS_SET

主板提供一个自动进入 BIOS 界面按钮，系统下按此键，关机后开机或重启后将自动进入 BIOS 设定画面。

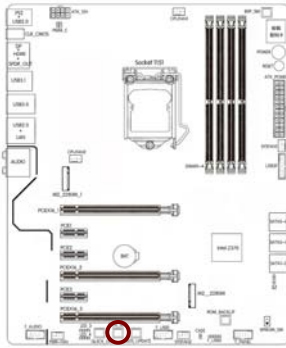

一键更新 BIOS 按钮：BIOS_UPDATE

将 BIOS 文件命名为 EBOOT.ROM，放入 U 盘根目录，系统下按此键，重新启动将自动进入 BIOS 更新界面。

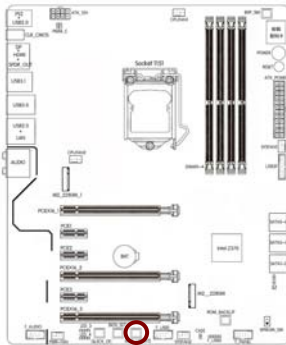

80P_SW 按钮:

主板提供一个板载数码卡，用于侦测 DEBUG/CPU 电压/内存电压/CPU 温度/芯片组温度。80P_SW 按钮则用于切换数码卡的这些显示功能。出货时，数码卡默认为侦测 DEBUG。按下该按钮，即可按 DEBUG/CPU 电压/内存电压/CPU 温度/芯片组的顺序，切换数码卡的显示功能。

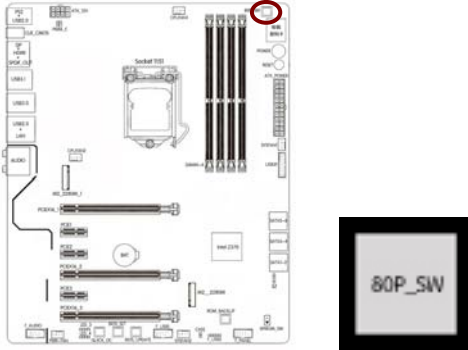

2-3 连接器和引脚连接头

电源连接器: ATX_POWER, ATX_12V

在与电源适配器相连时，请务必确认，电源适配器的接头安装方向正确，针脚对应顺序也准确无误。8-Pin 电源接口用于为 CPU 供电。

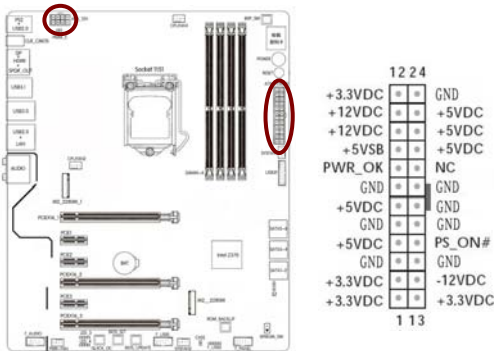

注意: 如果要安装功率消耗较大的硬件设备，请使用高功率的电源。

前面板开关和指示灯连接：F_PANEL

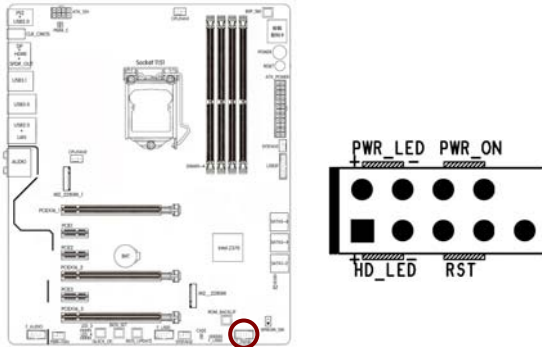

PWR_ON: ATX 电源开关。短接此引脚可以开机。

RST: 重启开关。短接此引脚，不需要关闭系统电源即可重新启动计算机。

PWR_LED: 电源指示灯。当系统电源开启时，此灯会亮起。

HD_LED: 硬盘指示灯。对硬盘进行数据存取时，此灯会亮起。

SATA 端口连接器：SATA1-6

主板提供 6 个 SATA3.0 6Gb/s 硬盘接口。

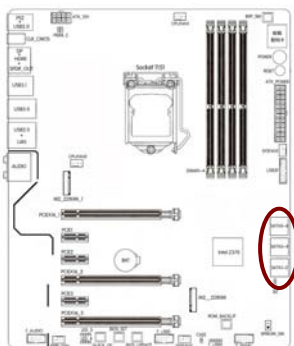

M.2 插槽

主板提供 2 个 M.2 插槽，其中，丝印为“M2_2280M_1”的插槽支持 PCIe 通道的 M.2 SSD，丝印为“M2_2280M”的插槽支持 PCIe 和 MSATA 通道的 M.2 SSD。2 个 M.2 插槽支持 2242/2260/2280 尺寸的 SSD，数据传输率最高可达 32Gb/s。

两个 M.2 插槽都支持 Intel OPTANE 技术。Intel OPTANE 技术是 Intel 最新推出的非易失性存储技术，是一种介于传统内存、固态硬盘之间，性能极高，延迟极低的技术。当使用 Intel OPTANE 技术时，M.2 插槽需使用 Intel OPTANE SSD，并搭配最新的处理器、安装 WIN10 64bit 系统和 RST 驱动，BIOS 设置中也要开启 Intel OPTANE 技术选项。

请依下列步骤将 M.2 SSD 正确地安装于插槽：

- ❑ 1. 请用螺丝起子依序将螺丝和螺柱拆下，将实际要安装的 M.2 SSD 找到适合螺丝孔位之后，先锁上螺柱。
- ❑ 2. 将 M.2 SSD 以斜角方式放入插槽。
- ❑ 3. 压住 M.2 SSD 之后，再将螺丝锁上。

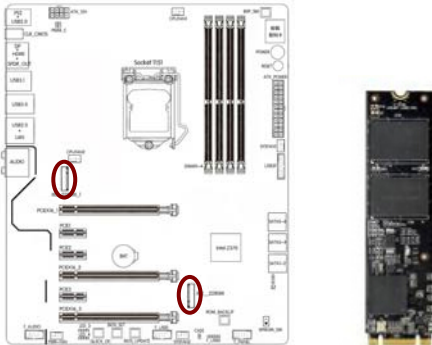

前置音频接口连接: F_AUDIO

您可以在前置面板接口上连接一个音频接口，它是和 I/O 前置面板连接规格兼容的。

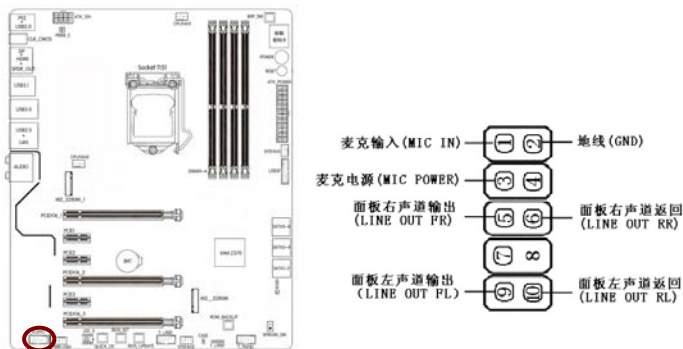

USB2.0 接口扩展连接头: F_USB1, F_USB2

主板提供 2 个 USB2.0 连接头，可扩展至 3 个 USB2.0 接口。USB2.0 接口传输速率最高可达到 480Mbps，可以提供高速的互联网连接、互动式电脑游戏，还可以同时运行高速的外围设备。

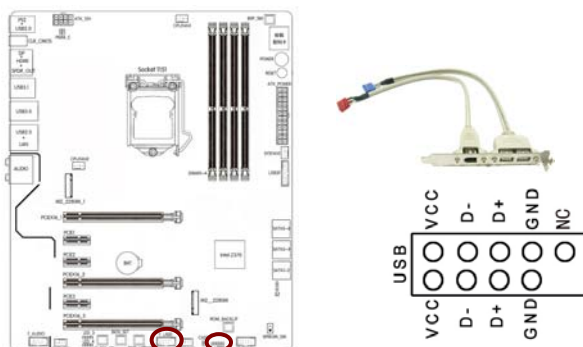

USB3.0 接口扩展连接头：USB3F

主板提供 1 个 USB3.0 连接头,可扩展至 2 个 USB3.0 接口。扩展后的 USB3.0 接口支持关机充电和快速充电! USB3.0 数据传输速率最高可达到 5Gbps。USB3.0 可向下兼容 USB 2.0 和 USB 1.1 设备。

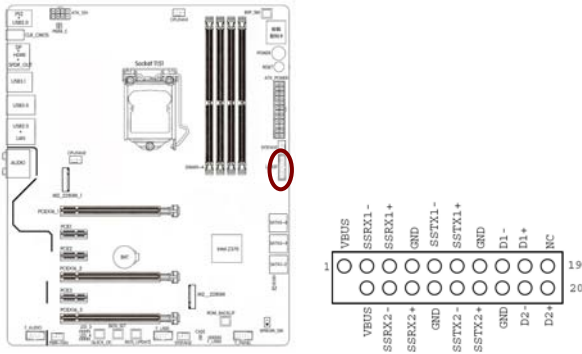

风扇插座：CPUFAN1, CPUFAN2, SYSFAN1, SYSFAN2, PWR_FAN

主板共提供 5 个风扇插座,用来降低 CPU 和系统的温度。其中 CPUFAN1 和 CPUFAN2 是 CPU 风扇插座,连接 CPU 风扇,用来降低 CPU 温度。

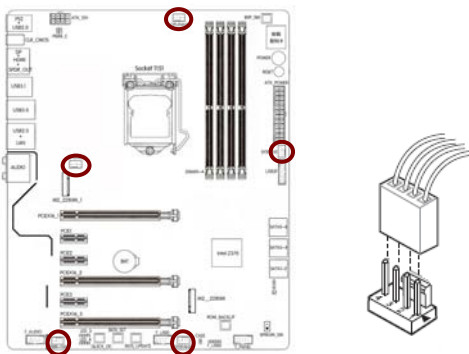

2-4 背板接口介绍

后置面板提供丰富的输入和输出接口。

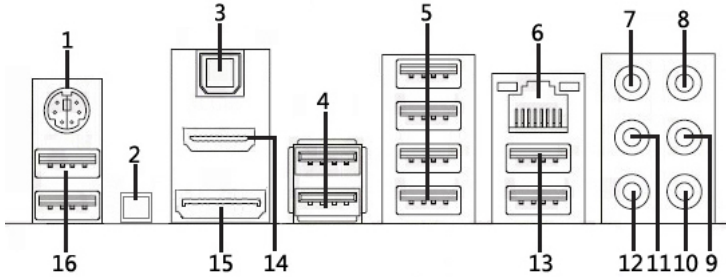

- ❑ 1、PS2 鼠标/键盘通用端口：将 PS2 鼠标/键盘插头连接到此连接端口。
- ❑ 2、CLR_CMOS 按钮：后置清 CMOS 按钮。
- ❑ 3、光纤 SPDIF 数字音频输出连接端口：这个端口可连接您的电脑至扩大机、耳机或是 Sony/Philips 数字连接格式（S/PDIF）兼容之设备。
- ❑ 4、USB3.1 设备连接端口（蓝色）：可连接到使用 USB3.1/3.0/2.0/1.1 接口的硬件设备。
- ❑ 5、USB3.0 设备连接端口（蓝色）：可连接到使用 USB3.0/2.0/1.1 接口的硬件设备。
- ❑ 6、网络连接端口：连接网线。请参考下表中各灯的说明。

❑ 信号状态	❑ 说明
❑ 亮橘色灯	❑ 传输速率 1 Gbps
❑ 亮绿色灯	❑ 传输速率 100 Mbps
❑ 灯灭	❑ 传输速率 10 Mbps



- ❑ 7、中央声道与重低音喇叭接口：这个接口可以连接中央声道与重低音喇叭。
- ❑ 8、音频输入接口：可将磁带、CD、DVD 播放器等的音频输出端连接到此音频输入接口。
- ❑ 9、音频输出接口：可连接耳机或喇叭等音频接收设备。

- ❑ 10、麦克风接口：此接口连接至麦克风。
- ❑ 11、后置环绕喇叭接口：本接口在 4/6/8 声道设置下是用来连接后置环绕喇叭。
- ❑ 12、侧边喇叭输出接口：本接口在 8 声道设置下用来连接侧边喇叭。
- ❑ 13、魔音 USB2.0 连接端口（红色）：采用独立的电源线路，有效地减少潜在的电流异常波动，为 USB 音频设备提供更纯净、无噪声的电源供应。
- ❑ 14、HDMI 连接端口：高清晰度多媒体接口。兼容 HDCP,可播放 HD DVD,Blu-Ray 与其他保护内容。
- ❑ 15、DisplayPort 接口：DisplayPort 是一种高清数字显示接口，可以连接电脑和显示器，也可以连接电脑和家庭影院。和 HDMI 一样，DisplayPort 也允许音频与视频信号共用一条线缆传输，支持多种高质量数字音频。但比 HDMI 更先进的是，DisplayPort 在一条线缆上还可实现更多的功能。在四条主传输通道之外，DisplayPort 还提供了一条功能强大的辅助通道。该辅助通道的传输带宽为 1Mbps，最高延迟仅为 500 μ s，可以直接作为语音、视频等低带宽数据的传输通道，另外也可用于无延迟的游戏控制。
- ❑ 16、USB2.0 连接端口（黄色）：这组连接端口是设计用来连接电竞版专业游戏 USB 设备。

2-5 Hardware Installation

This section will guide you through the installation of the motherboard. The topics covered in this section are:

- Preparing the motherboard
 - Installing the CPU
 - Installing the CPU fan
 - Installing the memory
- Installing the motherboard
- Connecting cables and setting switches

Safety Instructions

To reduce the risk of fire, electric shock, and injury, always follow basic safety precautions.

Remember to remove power from your computer by disconnecting the AC main source before removing or installing any equipment from/to the computer chassis.

Installing the CPU

The motherboard shipped in the box does not contain a CPU or memory. You need to purchase a CPU, a CPU fan assembly, and memory to complete this installation.

Be very careful when handling the CPU. Make sure not to bend or break any pins on the back. Hold the processor only by the edges and do not touch the bottom of the processor.

Use the following procedure to install the CPU onto the motherboard.

1. Unhook the socket lever by pushing down and away from the socket.
2. Lift the load plate. There is a protective socket cover on the load plate to protect the socket when there is no CPU installed.
3. Remove the protective socket cover from the load plate.
4. Remove the processor from its protective cover, making sure you hold it only by the edges.

It is a good idea to save the cover so that whenever you remove the CPU, you have a safe place to store it.

5. Align the notches in the processor with the notches on the socket.
6. Lower the processor straight down into the socket with out tilting or sliding it into the socket

Make sure the CPU is fully seated and level in the socket.

7. Close the load plate over the CPU and press down while you close and engage the socket lever.
8. There are many different fan types that can be used with this motherboard. Follow the instruction that came with you fan assembly. Be sure that the fan orientation is correct for your chassis type and your fan assembly.

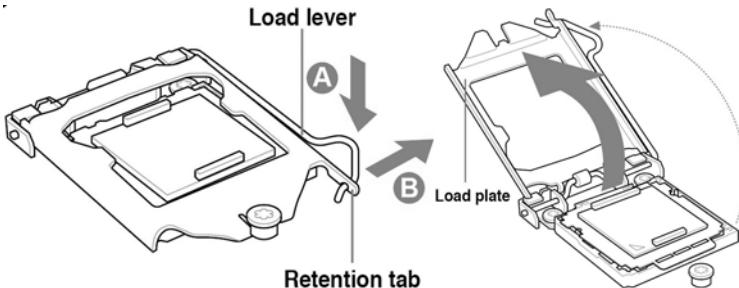

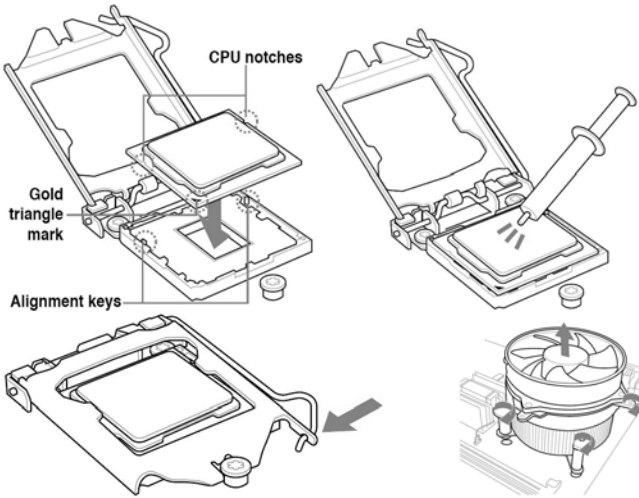

The CPU fits in only one correct orientation. DO NOT force the CPU into the socket to prevent bending the connectors on the socket and damaging the CPU!

Installing Memory DIMMs

Your new motherboard has 4 slots for DDR4 memory. They support dual channel DDR4 memory technology. There must be at least one memory bank populated to ensure normal operation. Use the following the recommendations for installing memory.

- ✓ One DIMM: Install into DIMM1. You can install the DIMM into any slot, however, slot 1 is preferred.
- ✓ 2 DIMMs: Install into DIMM1&DIMM3 slot, or DIMM2&DIMM4 slot, to build dual channel. .
- ✓ 3 DIMMs: don' t install 3 DIMMs, may cause fault.
- ✓ 4 DIMMs: Install into DIMM1、 DIMM2、 DIMM3、 DIMM4 slot.

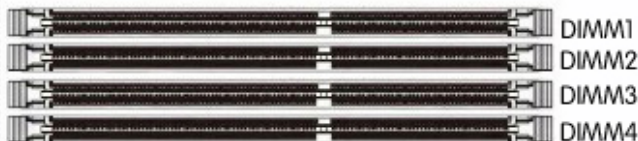

Use the following procedure to install memory DIMMs into the slots on the motherboard. Note that there is only one gap near the center of the DIMM slot. This slot matches the slot on the memory DIMM to ensure the component is installed properly.

- ✓ Unlock a DIMM slot by pressing the module clips outward.
- ✓ Align the memory module to the DIMM slot, and insert the module vertically into the DIMM slot. The plastic clips at both sides of the DIMM slot automatically lock the DIMM into the connector.

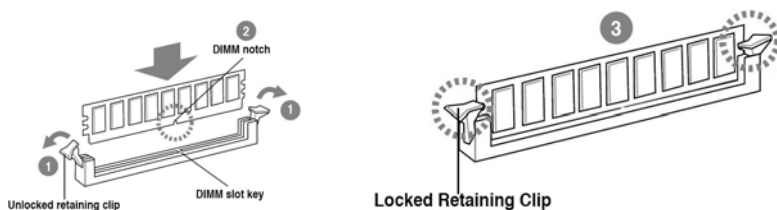

Installing the Motherboard

The sequence of installing the motherboard into the chassis depends on the chassis you are using and if you are replacing an existing motherboard or working with an empty chassis. Determine if it would be easier to make all the connections prior to this step or to secure the motherboard and then make all the connections. Use the following procedure to install the I/O shield and secure the motherboard into the chassis.

Be sure that the CPU fan assembly has enough clearance for the chassis covers to lock into place and for the expansion cards. Also make sure the CPU Fan assembly is aligned with the vents on the covers.

Installing the I/O Shield

The motherboard kit comes with an I/O shield that is used to block radio frequency transmissions, protects internal components from dust and foreign objects, and promotes correct airflow within the chassis.

Before installing the motherboard, install the I/O shield from the inside of the chassis. Press the I/O shield into place and make sure it fits securely. If the I/O shield does not fit into the chassis, you would need to obtain the proper size from the chassis supplier.

Securing the Motherboard into the Chassis

Most computer chassis have a base with mounting studs or spacers to allow the mother board to be secured to the chassis and help to prevent short circuits. If there are studs that do not align with a mounting hole on the motherboard, it is recommended that you remove that stud to prevent the possibility of a short circuit.

1. Carefully place the motherboard onto the studs/spacers located inside the chassis.
2. Align the mounting holes with the studs/spacers.
3. Align the connectors to the I/O shield.
4. Ensure that the fan assembly is aligned with the chassis vents according to the fan assembly instruction.
5. Secure the motherboard with a minimum of eight-to-ten screws.

Connecting header and Setting Switches

This section takes you through all the connections and switch settings necessary on the motherboard. This will include:

- Power Connections
 - 24-pin ATX power
 - 8-pin ATX 12V power
- Internal Headers
 - Front panel
 - USB Headers
 - Audio
- Serial ATA III
- Chassis Fans
- Rear panel USB 2.0 Adapter

■ Expansion slots

ATX power connectors (24-pin ATXPWR, 8-pin ATX12V)

These connectors are for an ATX power supply. The plugs from the power supply are designed to fit these connectors in only one orientation. Find the proper orientation and push down firmly until the connectors completely fit.

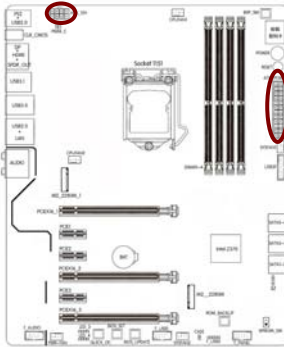

	1	2	3	4	5	6	7	8	9	10	11	12	13	14	15	16	17	18	19	20	21	22	23	24	
+3.3VDC																									
+12VDC																									
+12VDC																									
+5VSB																									
PWR_OK																									
GND																									
+5VDC																									
GND																									
+5VDC																									
GND																									
+3.3VDC																									
+3.3VDC																									



Serial ATA 3.0/6.0 Gb/s connectors (7-pin)

These connectors connect to Serial ATA 3.0/6.0 Gb/s hard disk drives and optical drives via Serial ATA 3.0/6.0 Gb/s signal cables.

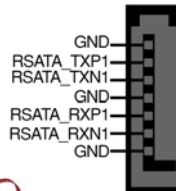
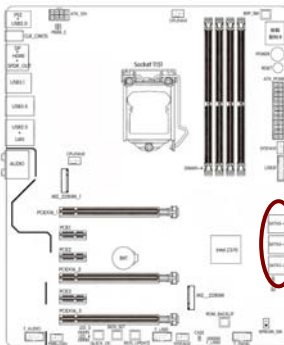

USB 3.0 connectors

This connector is for USB 3.0 devices.

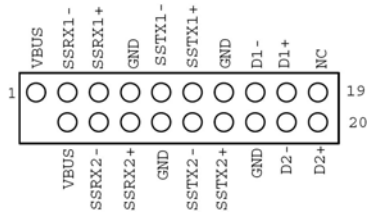
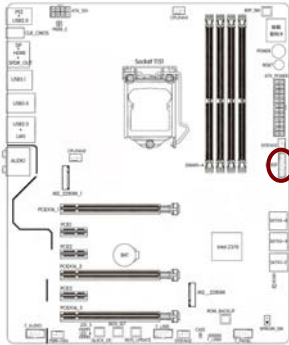

USB2.0 connectors

These connectors are for USB 2.0 ports. Connect the USB module cable to any of these connectors, then install the module to a slot opening at the back of the system chassis. These USB connectors comply with the USB 2.0 specification that supports up to 480Mbps connection speed.

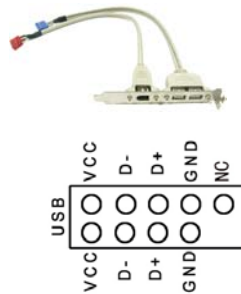
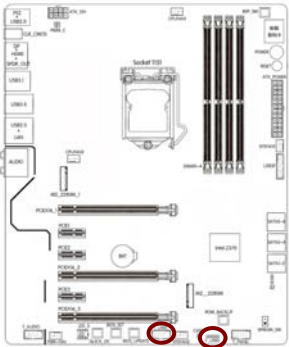

Front panel audio connector

This connector is for a chassis–mounted front panel audio I/O module that supports either High Definition Audio or AC⁹⁷ audio standard. Connect one end of the front panel audio I/O module cable to this connector.

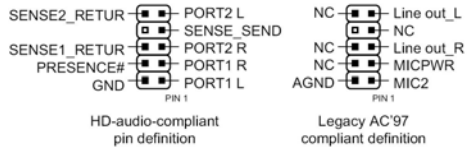
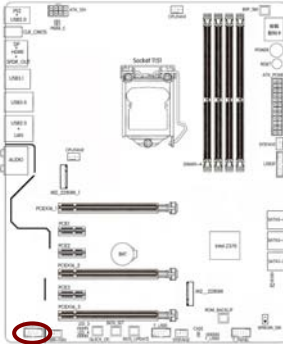

System panel connector

This connector supports several chassis–mounted functions.

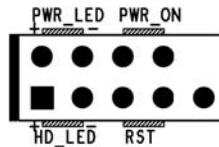
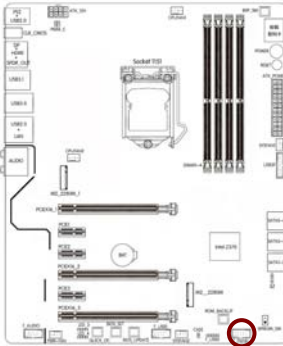

System power LED (2–pin PLED)

This 2–pin connector is for the system power LED. Connect the chassis power LED cable to this connector. The system power LED lights up when you turn on the system power, and blinks when the system is in sleep mode.

Hard disk drive activity LED (2-pin IDE_LED)

This 2-pin connector is for the HDD Activity LED. Connect the HDD Activity LED cable to this connector. The IDE LED lights up or flashes when data is read from or written to the HDD.

System warning speaker (4-pin SPEAKER)

This 4-pin connector is for the chassis-mounted system warning speaker. The speaker allows you to hear system beeps and warnings.

ATX power button/soft-off button (2-pin PWRSW)

This 2-pin connector is for the system power button.

Reset button (2-pin RESET)

This 2-pin connector is for the chassis-mounted reset button for system reboot without turning off the system power.

CPU, Chassis, and Power fan connectors (CPUFAN1, CPUFAN2, SYSFAN1, SYSFAN2, PWR_FAN)

Connect the fan cables to the fan connectors on the motherboard, making sure that the black wire of each cable matches the ground pin of the connector.

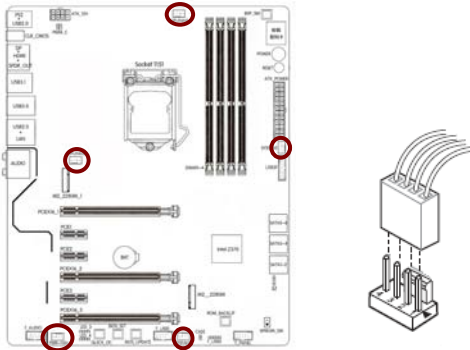

PCI Express x1 Slot

The PCI Express x1 slots that are designed to accommodate less bandwidth-intensive cards, such as a modem or LAN card. The x1 slot provides 250 MB/sec bandwidth.

PCI Express x16 Slot

The PCI Express x16 slot is reserved for a graphics or video card. The bandwidth of the x16 slot is up to 4GB/sec (8GB/sec concurrent).

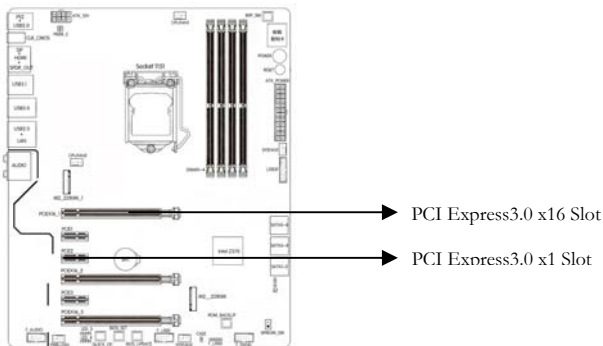

When installing a PCI Express x16 card, be sure the retention clip snaps and locks the card into place. If the card is not seated properly, it could cause a short across the pins. Secure the card's metal bracket to the chassis back panel with the screw used to hold the blank cover.

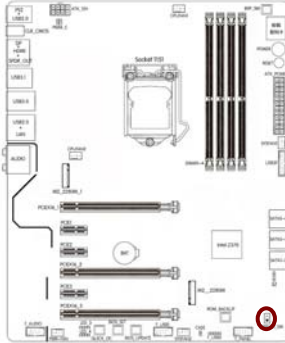

Dual BIOS switch: SPIROM_SW

The motherboard has one bios switch ,switch to SPIROM_A or SPIROM_B, choose which bios to use.



	SPIROM_B
	SPIROM_A

Auto overclocking button: QUICK_OC

The motherboard has one CPU Auto overclocking button , press this button,the operating system will restart, the CPU will Auto overclocking.

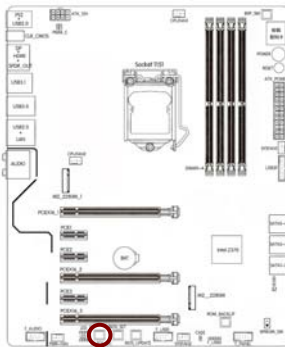

Auto enter bios interface button : BIOS_SET

press this button,when boot up or restart will auto enter bios interface.

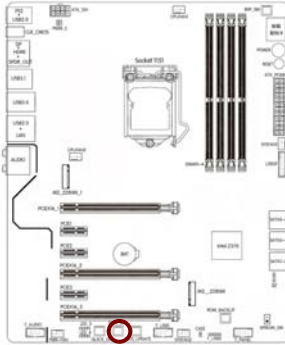

One key update bios button : BIOS_UPDATE

put The BIOS file named EBOOT.ROM in the U disk under the root directory, press this button to restart the operating system, will automatically enter BIOS update interface.

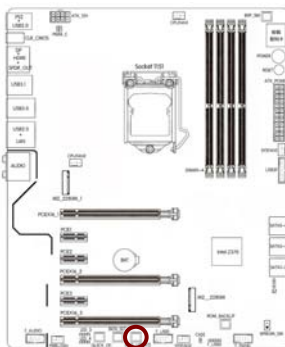

80P_SW button:

the motherboard has debug card LED light,can detect DEBUG/CPU Voltage/Memory Voltage/CPU temperature/Chipset temperature 。 80P_SW this button can switch these functions. the default is the debug function。

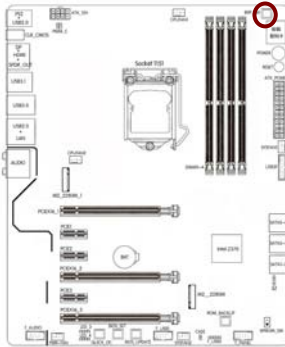

M.2 Slot

the motherboard has two M.2 slots , screen printing as "M2_2280M_1" slot, support PCIE channel M.2 SSD, silk screen as "M2_2280M" slot, support PCIE and MSATA channel M.2 SSD , the Data transmission rate is up to 32Gb/S, support 2242/2260/2280 size SSD and Intel OPTANE technology.

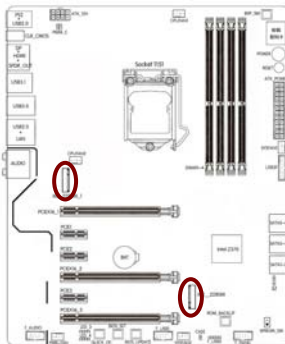

Back Panel IO Connector

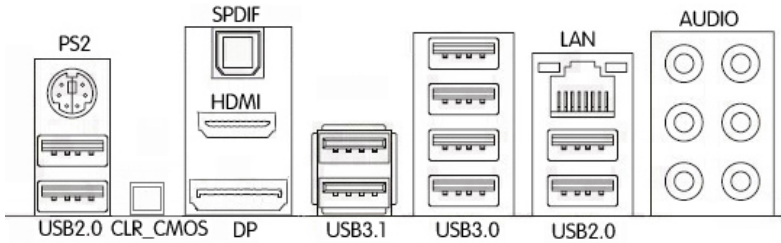

Parts	Use
PS/2 Mouse/ Keyboard Connector	This connector is for a PS/2 mouse/Keyboard.
LAN Jack	The standard RJ–45 jack is for connection to single Local Area Network (LAN). You can connect a network cable to it.
Lie–In(Blue)	Used for external CD player, tape player or other audio devices.
Line Out(Green)	This connector for speakers or headphones.
Side R/L(Gray)	Side surround speakers connector
HDMI	Onboard HDMI, connect to HDMI Monitor
DisplayPort	Onboard DisplayPort port, connect to DisplayPort Monitor
USB Ports	These connectors are for attaching USB devices such as keyboard, mouse, or other USB–compatible devices.

第三章 驱动程序安装说明

插入七彩虹主板驱动程序安装光盘，安装程序会自动运行，弹出下面窗口。



CAUTION: 安装完成硬件后，必须安装对应的驱动程序，才能发挥主板的强劲性能。



(请以实物为准)

驱动光盘能自动检测主板所使用的芯片组型号、声卡型号、板载显卡型号或者板载网卡型号，点击相应的按钮安装相应的驱动。

第四章 BIOS 设置

该章介绍如何通过 BIOS 设置来更改系统设置，详细内容请参考此章。

该章包含下列内容：

- ❑ Main（系统信息）
- ❑ Advanced（高级 BIOS 设置）
- ❑ Chipset（芯片组设置）
- ❑ C.Oclock（超频设置）
- ❑ Security（安全设定）
- ❑ Boot（启动设置）
- ❑ Exit（退出设置）



注意： 由于主板的 BIOS 版本在不断的升级，所以，本手册中有关 BIOS 的描述仅供参考。

4-1 进入 BIOS 主界面

本章提供了 BIOS Setup 程序的信息，让用户可以自己配置优化系统设置。

如下情形您需要运行 SETUP 程序：



注意： 1. 系统自检时屏幕上出现错误信息，并要求进入 SETUP 程序。2. 您想根据客户特征更改出厂时的默认设置。

进入设定程序

在计算机启动时，BIOS 进入开机自检(Post)程序，自检程序是一系列固定在 BIOS 中的诊断程序，当自检程序执行完成后，如果遇到错误会显示出如下信息：

Press F1 to Run Setup

Press F2 to Load default values and continue

（按 F1 键即可进入 BIOS 设置界面，按 F2 键装载默认值并进入系统）。

当自检程序执行完成后，没有遇到错误如果你想进入 BIOS，请按 DEL 键，直到进入 BIOS 界面。

如果此信息在您做出反应前就消失了，您可以关机后再开机或按机箱上的 Reset 键，重启您的电脑，也可以同时按下 <Ctrl> + <Alt>+<Delete> 来重启电脑。

控制键位

- < ↑ ↓ ← → > 向前、后、左、右移动选项
- < Enter > 选定此选项
- < Esc > 退出菜单或者从子菜单回到主菜单
- < F1 > 主题帮助，仅在状态显示菜单和选择设定菜单有效
- < F7 > 从 CMOS 中恢复前次的 CMOS 设定值
- < F8 > BIOS 界面截屏
- < F9 > 载入优化缺省值
- < F10 > 保存改变后的 CMOS 设定值并退出



进入 setup 程序之后，第一个屏幕就是主菜单。

主菜单

主菜单显示了 BIOS 所提供的设定项目类别。您可使用方向键选择不同的条目。对选定项目的提示信息显示在屏幕的底部。

子菜单

如果你发现在左边某一区域有向右的指针符号（如上图所示），这就意味此项附加了子菜单。选中此项，按下回车即可进入此选项子菜单。然后您可以使用控制键在子菜单直接移动并改变设定值。回到主菜单，按下<Esc>。

主题帮助

BIOS 设定程序提供了帮助屏幕。你可以通过简单地按下<F1>键从任何菜单中调出此帮助屏幕。此帮助屏幕列出了相应的键和可能的选择项目。按下<Esc>退出帮助屏。

4-2 BIOS 主界面

- ❑ Main（系统信息）
使用此菜单可查看 BIOS 和内存的基本信息，并设置 BIOS 时间和日期。
- ❑ Advanced（高级 BIOS 功能设定）
使用此菜单可对系统的高级特征进行设定。
- ❑ Chipset（高级芯片组功能设定）
使用此菜单可以对芯片组进行相应的设定，优化系统的性能表现。
- ❑ C.Oclock（超频设置）
使用此菜单可以对 CPU/芯片组以及内存进行超频，优化系统的性能表现。
- ❑ Security（安全设置）
使用此菜单可以对 BIOS 密码进行相应的设定。
- ❑ Boot（启动设置）
使用此菜单可以对计算机启动设备进行相应的设定。
- ❑ Exit（退出设置）
退出设置,包括保存退出/不保存退出/保存重启/不保存重启/载入优化缺省值等。

4-3 系统信息 (Main)



System Language (语言)

设置 BIOS 的语言界面。设定值有：English、中文等选项。

System Date (日期)

设置日期，日期的格式为<星期><月><日><年>。

- day 星期，从 Sun. (星期日)到 Sat. (星期六)。由 BIOS 定义，只读。
- Month 月份，从 Jan. (一月)到 Dec. (十二月)。
- Date 日期，从 1 到 31 可用数字键修改。
- Year 年，用户设定年份。

System Time (时间)

设置时间，时间的格式为<时><分><秒>。

4-4 高级 BIOS 设置 (Advanced)



LAN Configuration (网络设置)

Onboard LAN Controller

选择开启或关闭板载网卡控制器。设定值有: Disabled、 Enabled。

Launch PXE OpROM

选择开启或关闭无盘启动。设定值有: Disabled、 Enabled。

PC Health status (电脑健康状态)

Smart Fan Function

设置开启或关闭智能风扇功能。点击此选项，会出现以下子菜单:

Smart Fan Select

选择哪个风扇启用智能运行。设定值有: CPU Fan1 (CPU 风扇 1)、CPU Fan2 (CPU 风扇 2)、System Fan1 (系统风扇 1)。

Smart Fan Mode

设置智能风扇模式。设定值有：Normal（正常）、Quiet（静音）、Silent（无声）、Manual（手动）、Disabled（禁用）。

 CPU/ System Temperature

显示当前 CPU/系统的温度。

 CPU Fan / System Fan Speed

显示当前 CPU 风扇/系统风扇运行的转速。

 Core /DIMM / VCCSA/VCCIO/PCH Voltage

显示“Core /内存/ VCCSA/VCCIO/PCH”电压监控。

 TCC Activation Temperature

显示 TCC 启动温度值。

Power Management Setup（电源管理设置）

 Resume By PME

设置 PME 唤醒。设定值有：Disabled、Enabled。

 Resume By USB

设置 USB 唤醒。设定值有：Disabled、Enabled。

 Resume By PS2 KB

设置 PS2 键盘唤醒。设定值有：Disabled、Enabled。

 Resume By PS2 MS

设置 PS2 鼠标唤醒。设定值有：Disabled、Enabled。

 Resume By RTC Alarm

设置定时唤醒。设定值有：Disabled、Every Day、Enabled。如果选“Enabled”，则会弹出具体唤醒时间的设置。以日期/小时/分/秒的格式来表示。各项目合理的范围是：Day/日期(1-31, 0 则表示每一天), Hour/时(0-23), Minute/分(0-59), Second/秒(0-59)。

 Restore AC Power Loss

设置断电后再来电，PC 的状态。设定值有：Power Off（关机）、Power On（开机）、Last State（上次断电时的状态）。

ACPI Settings (ACPI 高级配置)

ACPI Sleep State

选择 OS 下待机模式。设定值有: Suspend Disabled、S3 (Suspend to RAM)。

CPU Configuration (CPU 设置)

Active Processor Cores

设置激活处理器核心个数。设定值有: ALL、1、2、3、4、5。

Limit CPUID Maximum

设置开启或关闭最大 CPUID 指令限制。设定值有: Disabled、Enabled。

Intel Virtualization Technology

设置开启或关闭 Intel 虚拟化技术。Intel 虚拟化技术让您可以在同一平台的独立数据分割区, 执行多个操作系统和应用程序。设定值有: Disabled、Enabled。

Package C State limit

设置 C 状态限制。例如限制到 C2, 就不能进入 C3 更节能的状态, 默认是自动。

Enhanced Halt (C1E)

设置增强型 C 状态。设定值有: Disabled、Enabled。

Intel (R) Speed Shift Technology

设置是否开启 Intel 变速技术。设定值有: Disabled、Enabled。

SATA Configuration (SATA 设置)

SATA Mode

设置 SATA 接口的工作模式。设定值有: AHCI、Intel RST Premium With Intel Optane System Acceleration (Intel Optane 技术, Intel 最新的非易失性存储技术)。

SATA Port

SATA 接口的连接情况和相关设置。

USB Configuration (USB 设置)

All USB Devices

选择开启或关闭 USB 设备。设定值有: Disabled、Enabled。

Legacy USB Support

设置开启或关闭传统 USB 设备功能。使用 USB 键盘鼠标必须设置为“Enabled”。设定值有：Enabled、Disabled。

 USB3.1 Controller

设置是否开启 USB3.1 功能。设定值有：Disabled、Enabled。

Super IO Configuration (超级 IO 配置)

 Serial Port

启动和关闭串口控制器。设定值有：Disabled、Enabled。

 Change Settings (更改设置)

此选项用来改变串口地址。

Trusted Computing (可信计算)

 TPM Support

开启或关闭 TPM (系统下内置加密) 功能。TPM 标准的安全芯片，能有效地保护 PC、防止非法用户访问。设定值有：Disabled、Enabled。

4-5 芯片组设置 (Chipset)



System Agent Configuration (北桥设置)

Initiate Graphic Adapter

设置主显示设备。设定值有：Auto（自动）、IGD（集显）、PCI Express（独显）。

IGD Multi-Monitor

设置集显多显示器。设定值有：Disabled、Enabled。

PCH Configuration (南桥设置)

Azalia HD Audio

开启或关闭高保真音频控制器。设定值有：Disabled、Enabled。

Case Open Warning

设置机箱打开警告。设定值有：Disabled（禁用）、Enabled（启用）、Clear（清除）。

ME Configuration (ME 设置)

ME Control

设置开启或关闭 ME 固件。设定值有：Disabled、Enabled。

ME FW Version

显示 ME FW 版本。

4-6 超频设置 (C.Oclock)



CPU OverClocking Configuration (CPU 超频功能设置)

EIST

EIST 全名为“Enhanced Intel SpeedStep Technology”，它是一种智能降频技术，它能够根据不同的系统工作量自动调节处理器的电压和频率，以减少耗电量和发热量。设定值有：Disabled、Enabled。

Turbo Boost

Turbo Boost，顾名思义，就是加速模式，它是基于 Nehalem 架构的电源管理技术，通过分析当前 CPU 的负载情况，智能地完全关闭一些用不上的核心，把能源留给正在使用的核心，并使它们运行在更高的频率，进一步提

升性能；相反，需要多个核心时，动态开启相应的核心，智能调整频率。这样，在不影响 CPU 的 TDP 情况下，能把核心工作频率调得更高。设定值有：Disabled、Enabled。

Power Limit 1-4 Override

设置 CPU 功率限制 1-4 档。

Boot performance Mode

设置启动性能模式。设定值有：Max Non-Turbo Performance(最大非 Turbo 效能)、Max Battery (最大电池)、Turbo Performance (Turbo 效能)。

TDP LOCK

设置 TDP 功耗限制。设定值有：Disabled、Enabled。

CPU Ratio

设置 CPU 倍频。

1-6Core Ratio Limit Override

这个设置 CPU 的睿频技术，可以修改睿频的目标频率，注意这里的 1-6 不是 1-6 号的每一个核心，而是核心的个数。参与工作的核心数量越少，睿频的频率就越高。

Memory Configuration (内存超频功能设置)

Memory Profiles (内存参数设置)

设置内存时序。设定值有：Default Profile (自动)、Custom Profile (自定义)、XMP Profile1。XMP 全名为 Extreme Memory Profile，它是英特尔提出的一种内存超频模式，就是把内存的超频频率和参数设置以文件的方式存在内存条的 SPD 模块中。BIOS 启动 XMP 就是直接从 SPD 中读取超频设置参数设置内存频率。选择“Manual”，可对内存频率进行超频设置。以下内容可作为超内存频率时参考使用：

Memory Frequency

设置内存频率。

tCL

此项控制了 C A S 延迟，它决定了在 SDRAM 在接收指令后开始读取的延迟时间（在时间周期中）。

tRCD/ tRP

设置控制 S D R A M 内存时钟周期数。

tRAS

此项控制 S D R A M 内存时钟周期数的 R A S 最小值。

 tFAW

设置同一 rank 中允许同时发送大于四个行激活命令的间隔时间。

 tRFC

该字段用于选择自动刷新周期时间。

 tRRD

选择不同 b a n k 的列与列间的延迟时间。

 tRTP

选择预充电时间。

Over Voltage Configuration (电压设置)

 CPU/ VCCSA / VCCIO / DIMM/CPU VDroop Voltage

设置 CPU/VCCSA/VCCIO/内存/ CPU VDroop 电压。

LED Light Configuration (LED 灯设置)

 LED Light

设置是否开启 LED 灯，指的是主板音频分割区的灯带。设定值有：Disabled、Enabled。

 LED Light Color

设置 LED 灯的颜色。设定值有：Blue (蓝色)、Orange (橙色)、Red (红色)、Green (绿色)、White (白色)、Yellow (黄色)、Purple (紫色)、Rainbow (彩色)。

 LED Light Behavior

设置 LED 灯的模式。设定值有：Normal (常规)、Breathe (呼吸)、Blink (闪烁)、Audio Tempo (音频节奏)。

 LED Light Breathe Timer

设置 LED 灯处于呼吸模式时的周期。设定值有：1-10Sec (1-10 秒)。

 Over Heat Warning

设置是否开启过热警告。设定值有：Disabled、Enabled。

Profile Configuration (配置文件设置)

- save Profile

设置是否保存存储文件。

- Restore last setting

设置还原到之前的设置。设定值有：Disabled、Enabled。

4-7 安全设置 (Security)

Administrator Password

本项目用于设置系统管理员密码。请按照下列步骤操作：

- 1. 选择“Administrator Password”项目并按下“Enter”键。
- 2. 当“Greate New Password”窗口出现时，输入欲设置的密码，可以是六个字节内的英文、数字与符号，输入完成按下“Enter”键。
- 3. 按下“Enter”键后会弹出“Confirm New Password”窗口，再一次输入密码以确认密码正确。若出现“Invalid Password”提示信息，代表于密码确认时输入错误，需重新操作。
- 若要更改系统管理员的密码，请依照上述程序再运行一次密码设置。
- 按“F10”键保存后退出，密码设置即可生效。

User Password Status

此选项用于设置普通用户密码。请按照下列步骤操作：

- 1. 选择“User Password”项目并按下“Enter”键。
- 2. 在“Greate New Password”窗口出现时，请输入欲设置的密码，可以是六个字节内的英文、数字与符号。输入完成按下 <Enter>。
- 3. 接着会再出现“Confirm New Password”窗口，再一次输入密码以确认密码正确。若出现“Invalid Password”提示信息，代表于密码确认时输入错误，需重新操作。
- 若要更改用户的密码，请依照上述程序再运行一次密码设置。
- 按“F10”键保存后退出，密码设置即可生效。

4-8 启动设置 (Boot)



□ Operating system select

选择操作系统。当使用 Coffee Lake 处理器时，此处需要设定为“Windows 8.X /10”选项。设定值有：Windows 7 or other OS、Windows 8.X/10、Manual。

□ Launch Storage OpROM

开启或关闭 ROM 的传统大型存储设备启动选项。设定值有：Disabled、Enabled。

□ Bootup Numlock State

设置启动时小数字键盘状态，设定值有：On（开）、Off（关）。

□ Quiet Boot

设置安静启动。设定值有：Disabled、Enabled。

□ Update System BIOS

设置更新系统 BIOS。设定值有：Disabled、Enabled。

□ Boot mode select

选择引导模式。设定值有：LEGACY（传统）、UEFI。

Set Boot Priority

启动设备优先权设置。如果用户要安装操作系统, 请把“Boot Option #1”设为你的光驱设备(CD-ROM)或你的 U 盘设备(前提是你的光驱里面的光盘有操作系统或者是你的 U 盘里有 PE 系统), 设置完成后按“F10”键保存退出, 系统会从你的光驱或 U 盘启动。

4-9 退出设置 (Exit)

退出选项包括: 保存并退出设置/不保存并退出设置/保存设置并重启/不保存设置并重启/保存设置/不保存设置/载入优化缺省值。

Save Changes and Exit (退出设置程序并储存设置)

□ 若当你选择“Save Changes and Exit”, 就会出现如下的信息:

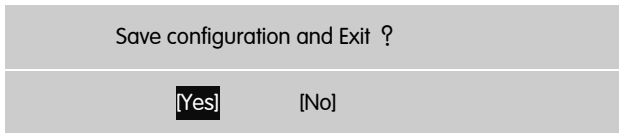

- 选择“Yes”并按下“Enter”键, 即可储存所有设定结果; 若不想储存, 选择“No”或按“Esc”键皆可回到主菜单中。

4-10 BIOS Setting

Enter BIOS Main Menu

BIOS (Basic Input and Output System) records hardware parameters of the system in the CMOS on the motherboard. Its major functions include conducting the Power-On Self-Test (POST) during system startup, saving system parameters and loading operating system, etc.

When computer startup, and then enter the boot self test (POST) program, if there are any errors will be shown the following information:

Press F1 to Run Setup

Press F2 to Load default values and continue

(Press the <F1> key to enter BIOS Setup, Press the <F2> key to Load default values and enter the system)

When the boot self test (POST) program is completed, if you want to enter the BIOS, please press the DEL key, enter the BIOS main menu.



- If the boot self test (POST) program information is disappeared before you respond, you can turn it off and then turn on, or press the Reset button on the chassis to restart your computer, can also press < Ctrl > + < Alt > + < Delete > to restart the computer.
- Since the BIOS version of the motherboard is constantly upgrading, the BIOS description is only for reference.

BIOS Setup Program Function Keys

- < ↑ ↓ ← → > Move the selection bar to select a setup menu
- < Enter > Execute command or enter a menu
- < Esc > Main Menu: Exit the BIOS Setup program
Submenus: Exit current submenu
- < F1 > Help topic (Only the status display menu and select Settings menu are valid)
- < F7 > Restore the previous CMOS settings
- < F8 > Capture the current screen as an image
- < F9 > Load Optimized Defaults
- < F10 > Save all the changes and exit the BIOS Setup program

BIOS Setup Menus

- Main** (System Information)
Use this menu to view BIOS and memory basic information, and set the BIOS time and date.
- Advanced** (Advanced BIOS Features)
Use this menu to set the advanced features of the system.
- Chipset** (Advanced Chipset Features)

Using this menu, the chip group can be set to optimize the performance of the system

❑ **C.Oclock** (OverClock Settings)

Using this menu,the CPU/chipset and memory can be overclocking to optimize the performance of the system

❑ **Security** (security settings)

Use this menu to set the BIOS password accordingly

❑ **Boot** (Startup Settings)

Use this menu to set the computer boot device accordingly

❑ **Exit** (exit Settings)

including save exit/do not save exit/save restart/do not save restart/load optimization defaults, etc

Main (System Information)

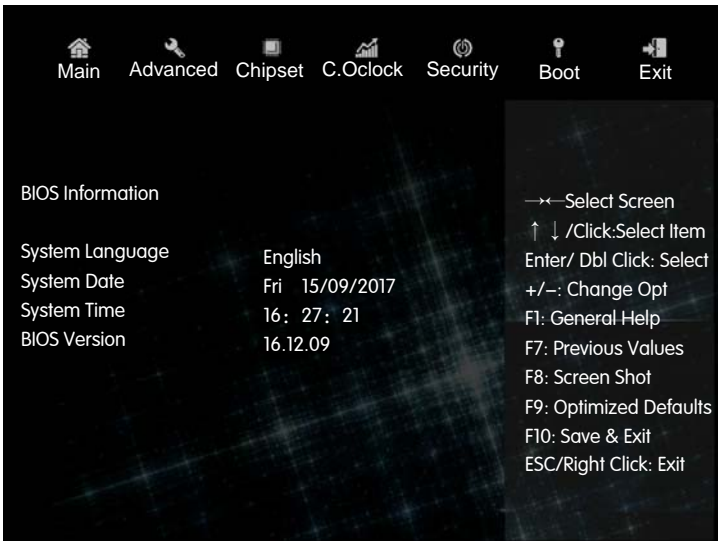

System Language

Selects the default language used by the BIOS.

The set values are: English, Chinese, etc.

System Date

Set the date, the date format is <week><month><date><year>

- Week:from Sun.to Sat.,defined by the BIOS, read-only
- Month:from Jan.to Dec.
- Date:from 1 to 31,can be modified with numeric keys
- Year:user set the year fields

System Time

Set the time, the time format is<hour><minute><second>。

Advanced (Advanced BIOS Features)

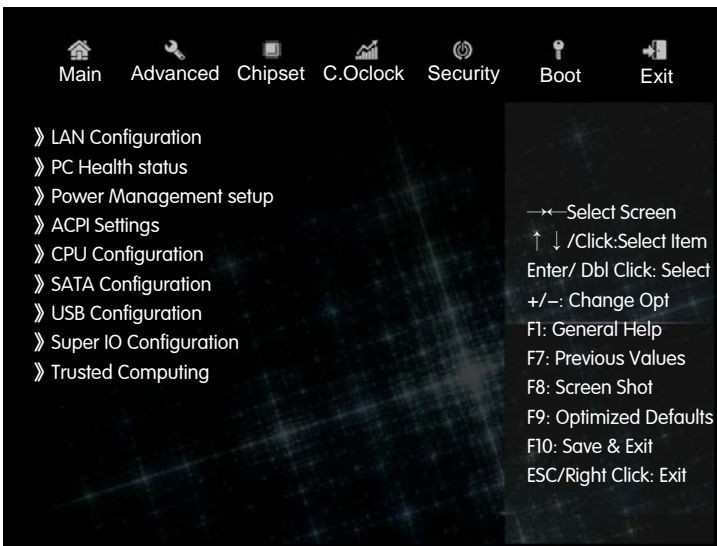

LAN Configuration

Onboard LAN Controller

Select to open or close the onboard network card controller.

The set values are: Disabled and Enabled。

Launch PXE OpROM

Select to open or close diskless booting.

The set values are: Disabled and Enabled.。

PC Health status

Smart Fan Function

Set open or close the smart fan function.

Click this option to show the following menu.:

Smart Fan Select

Select which fan to enable smart operation.

The set values are: CPU Fan1、CPU Fan2、System Fan1

Smart Fan Mode

Set the smart fan mode.

The set values are:Normal、Quiet、Silent、Manual、Disabled.

CPU/ System Temperature

Displays the current CPU/system temperature.

CPU Fan / System Fan Speed

Displays the current CPU fan/system fan running speed.。

Core /DIMM / VCCSA/VCCIO/PCH Voltage

Displays Core /memory/ VCCSA/VCCIO/PCH voltage monitoring.

TCC Activation Temperature

Displays TCC starting temperature value.

Power Management Setup

Resume By PME

Set PME wake-up.The set values are:Disabled、Enabled.。

Resume By USB

Set USB wake-up. The set values are: Disabled、Enabled。

Resume By PS2 KB

Set PS2 keyboard wake-up. The set values are: Disabled、Enabled。

Resume By PS2 MS

Set PS2 mouse wake-up. The set values are: Disabled、Enabled。

Resume By RTC Alarm

Set definite time wake-up. The set values are: Disabled、Every Day、Enabled。 if select “Enabled” , it will pop up specific wake-up time Settings. the format is date/hour/minute/second. Each project reasonable scope is: : Day (1-31, 0 represent each day) , Hour(0-23), Minute(0-59), Second(0-59).

Restore AC Power Loss

after power failure , set the state of the PC when the power restores again. The set values are: Power Off、Power On、Last State (State of the last power outage)

ACPI Settings

ACPI Sleep State

Select the standby mode in OS state.

The set values are: Suspend Disabled、S3 (Suspend to RAM) 。

CPU Configuration

Active Processor Cores

Set the number of activation processor cores.

The set values are: ALL、1、2、3、4、5。

Limit CPUID Maximum

Set to open or close the maximum CPUID instruction limit.

The set values are: Disabled、Enabled。

Intel Virtualization Technology

Set to open or close the Intel virtualization technology. Intel virtualization technology allows you to separate partitions of data on the same platform, performing multiple operating systems and applications. The set values are: Disabled、Enabled。

Package C State limit

Set C State limit. For example, if you limit to C2, you can't go to C3 more energy efficient state, default is auto.

Enhanced Halt (C1E)

Set the enhanced C states. The set values are: Disabled、 Enabled。

Intel (R) Speed Shift Technology

Set whether to open Intel (R) Speed Shift Technology.

The set values are: Disabled、 Enabled。

SATA Configuration

SATA Mode

Set the work mode of the SATA. The set values are: AHCI、 Intel RST Premium With Intel Optane System Acceleration (Intel Optane technology , Intel's latest nonvolatile storage technology) 。

SATA Port

SATA Port connection and related Settings.

USB Configuration

All USB Devices

Select to open or close the USB device. The set values are: Disabled、 Enabled。

Legacy USB Support

Set to open or close traditional USB device functions. If you use the USB keyboard mouse , you have to set it to "Enabled".

The set values are: Enabled、 Disabled。

USB3.1 Controller

Set whether to open the USB3.1 function.

The set values are: Disabled、 Enabled。

Super IO Configuration

Serial Port

Start and close the serial port controller.

The set values are:Disabled、Enabled。

Change Settings

This option is used to change the serial address.

Trusted Computing

TPM Support

Open or close the TPM (system under the built-in encryption) function.TPM standard security chip, and can effectively protect the PC, to prevent illegal users access.

The set values are:Disabled、Enabled。

Chipset (Advanced Chipset Features)

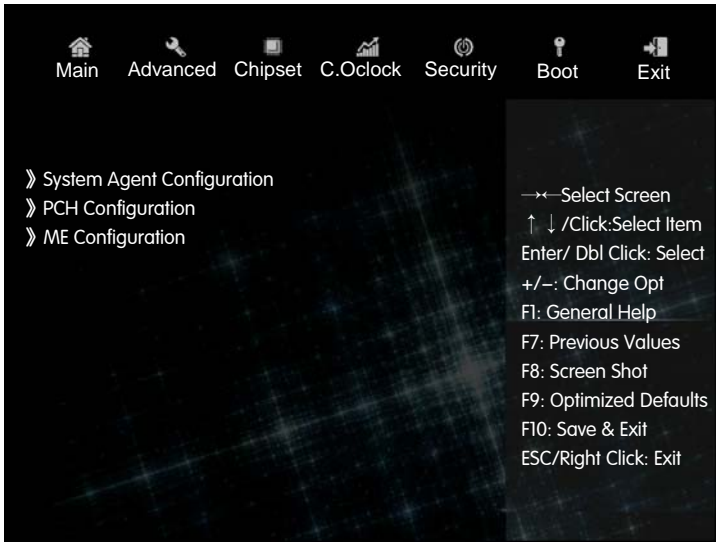

System Agent Configuration (North Bridge configuration)

Initiate Graphic Adapter

Set the main display device.

The set values are:Auto、IGD、PCI Express。

❑ IGD Multi–Monitor

Set IGD Multi–Monitor. The set values are: Disabled、Enabled。

PCH Configuration (South Bridge Configuration)

❑ Azalia HD Audio

Open or close the hi–fi audio controller.

The set values are: Disabled、Enabled。

❑ Case Open Warning

Set the alarm when the case has been opened.

The set values are: Disabled、Enabled、Clear.

ME Configuration

❑ ME Control

Set to open or close the ME firmware.

The set values are: Disabled、Enabled。

❑ ME FW Version

Displays ME the FW version.

C.Oclock (OverClock Settings)

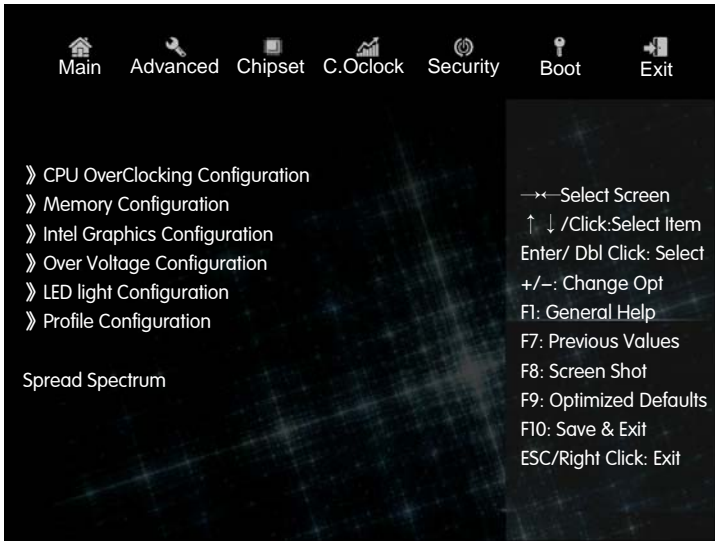

CPU OverClocking Configuration

EIST

EIST, the full name of "Enhanced Intel SpeedStep Technology", it is an intelligent downfrequency technology, It can automatically adjust the voltage and frequency of the processor according to different system workload, to reduce electricity consumption and heat. The set values are: Disabled、Enabled。

Turbo Boost

Turbo Boost, it is Turbo Mode, it is a power management technology based on Nehalem architecture, through the analysis of the current situation of the load of CPU, intelligent completely shut down some not to use the core, the core is to use energy, and make them run at a higher frequency, to further enhance the performance; instead, the need for multiple core, dynamic and open the corresponding core intelligent adjustment, frequency. Thus, the core operating frequency can be tuned higher without affecting the TDP of the CPU. The set values are: Disabled、Enabled.

Power Limit 1-4 Override

CPU power limit 1-4。

Boot performance Mode

Set boot performance mode.

The set values are: Max Non-Turbo Performance、Max Battery、Turbo Performance.

TDP LOCK

Set TDP power limit. The set values are: Disabled、Enabled.

CPU Ratio

Set CPU Ratio.

1-6Core Ratio Limit Override

This setup of CPU core frequency technology, you can modify the frequency of the target frequency, note that the 1-6 here is not 1-6 per core, but the number of cores. The less the number of cores involved, the higher the frequency.

Memory Configuration (Memory overclocking function settings)

Memory Profiles (memory parameter setting)

Set memory timings.

The set values are:Default Profile (AUTO) 、 Custom Profile (custom) 、 XMP Profile1。

The full name of XMP is Extreme Memory Profile , It is a memory overclocking mode proposed by Intel, that is, the memory overclocking frequency and parameters are set in the memory of the SPD module. The BIOS boot XMP simply reads the overclocking settings parameter from the SPD and sets the memory frequency. Select "Manual" to set the memory frequency to overclocking. The following can be used as reference for ultra memory frequencies:

Memory Frequency

Set memory frequency.

tCL

This controls the latency of the C A S, which determines the delay time (in the time cycle) when the SDRAM starts reading after the receive command.

tRCD/ tRP

Set to control S D R A M memory clock cycle.

tRAS

This control the minimum of S D R A M memory clock cycle R A S.

tFAW

Sets the interval in the same rank that allows more than four row activation commands to be sent at the same time.

tRFC

This field is used to select the auto refresh cycle time.

tRRD

Select the delay time between columns and columns of different B a n K.

tRTP

Select precharge time.

Over Voltage Configuration

- CPU/ VCCSA / VCCIO / DIMM/CPU VDroop Voltage
Set CPU/VCCSA/VCCIO/DIMM/CPU VDroop Voltage.

LED Light Configuration

- LED Light
Sets whether to turn on the LED light, referring to the ribbon of the audio section of the motherboard.
The set values are:Disabled、 Enabled。
- LED Light Color
Set the color of the LED light.
The set values are:Blue、 Orange、 Red、 Green、 White、 Yellow、 Purple、 Rainbow.
- LED Light Behavior
Set the LED light mode.
The set values are:Normal、 Breathe、 Blink、 Audio Tempo.
- LED Light Breathe Timer
Set the period when the LED light is in “breathe” mode.
The set values are:1–10Sec.
- Over Heat Warning
Sets whether to turn on overheating warning.
The set values are:Disabled、 Enabled。

Profile Configuration

- save Profile
Sets whether to save the storage file.
- Restore last setting
Set to restore to previous settings.
The set values are:Disabled、 Enabled。

Security (security settings)

Administrator Password

This project is used to set the system administrator password. Please follow these steps:

- ❑ 1. Select “Administrator Password” and press the "Enter" button.
- ❑ 2. When “Greate New Password” appears, enter the password you want to set, which can be in six bytes in English, numbers and symbols, and then press the "Enter" button.
- ❑ 3. After pressing the "Enter" button, the "Confirm New Password" window appears, Enter the password again to make sure the password is correct. If there is a "Invalid Password" prompt message, which represents an error when the password is confirmed, it needs to be reenter.
- ❑ If you want to change the user's password, please run again in accordance with the above procedure password settings.
- ❑ Press the "F10" key to save and then exit, the password settings will be effective.

User Password Status

This option is used to set the common user password.

Please follow these steps:

- ❑ 1. Select “User Password” and press the "Enter" button.
- ❑ 2. When the "Greate New Password" window appears, enter the password you want to set, it can be in six bytes in English, numbers and symbols. After enter complete press < Enter >.
- ❑ 3. Then there is the "Confirm New Password" window, and again enter the password to make sure the password is correct. If there is a "Invalid Password" prompt message, which represents an error when the password is confirmed, it needs to do it again.
- ❑ if you want to change a user's password, please run the password settings again in accordance with the above procedure.
- ❑ Press the "F10" key to save and then exit, the password settings will be effective.

Boot (Startup Settings)



❑ Operating system select

Select operating system. When you use the Coffee Lake processor, you need to set the "Windows 8.X /10" option here.

The set values are: Windows 7 or other OS、 Windows 8.X/10、 Manual.

❑ Launch Storage OpROM

Open or close ROM traditional large storage device startup options.

The set values are: Disabled、 Enabled.

❑ Bootup Numlock State

Set small numeric keypad status at boot time.

The set values are: On、 Off.

❑ Quiet Boot

Set quiet start. The set values are: Disabled、 Enabled.

❑ Update System BIOS

Set to update system BIOS. The set values are: Disabled、 Enabled.

❑ Boot mode select

Select boot mode. The set values are: LEGACY、 UEFI.

Set Boot Priority

Boot device priority settings.If the user wants to install the operating system, please set "Boot Option #1" as your drive device (CD–ROM) or your U disk device (provided that your CD–ROM drive has an operating system or your U disk has an PE system), When setup is complete, press the "F10" key to save and exit. The system will boot from your drive or U disk.

Exit (exit Settings)

The exit options include saving and exiting settings / not saving, exiting settings / saving settings, and restarting / saving settings, and restarting / saving settings / not saving settings / loading, optimizing defaults.

Save Changes and Exit

- If you select "Save Changes and Exit" ,the following message will appear:

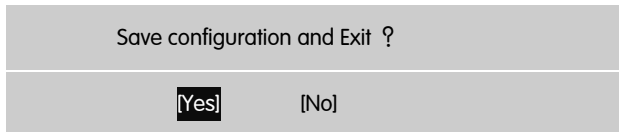

- Select "Yes" and press the "Enter" button to store all the settings. If you don't want to save, select "No" or press "Esc" to return to the main menu.

Copyright Notice

The material in this document is the intellectual property of Colorful Technology and Development CO, LTD. We take every care in the preparation of this document, but no guarantee is given as to the correctness of its contents. Our products are under continual improvement and we reserve the right to make changes without notice.

Disclaimer

The products name we mentioned in this manual is only for identifying, all of the brands belong to other company.

The registered trademarks of IBM, VGA and PS/2 belong to International Business Machines.

The registered trademarks of Intel, Pentium, Pentium II , Celeron, Pentium III and Pentium 4 belong to Intel.

The registered trademark of Athlon belongs to Advanced Micro Devices, Inc.

The registered trademarks of Microsoft, MS-DOS, Windows 95/98/NT, Windows2000/XP etc. belong to Microsoft.

All of the trademarks in this manual have been registered.

Trademarks

All trademarks in this manual are properties of their respective owners.

- NVIDIA® is registered trademark of NVIDIA Corporation.
- AMD® is registered trademarks of AMD Corporation.
- Intel® is registered trademarks of Intel Corporation.
- Windows® is registered trademarks of Microsoft Corporation.
- AML® is registered trademark of American Megatrends Inc.

- ■ Award® is a registered trademark of Phoenix Technologies Ltd.
- ■ Realtek® is registered trademark of Realtek Semiconductor Corporation.
- ■ JMicon® is registered trademark of JMicon Technology Corporation.
- ■ ASMedia® is registered trademark of ASMedia Technology Inc.

Technical Support

If a problem arises with your system and no solution can be obtained from the user's manual, please contact your place of purchase or local distributor. Or our engineer, send the follow information to us!

Customer name _____ Purchase date _____

Contacts _____ Contact phone _____

Contact address _____ Product model _____

Product SN _____ Dealer name _____

Dealer phone _____ Dealer address _____

Website: www.colorful.cn

Service hotline: +86400-678-5866