

TECHNICAL MANUAL

Of

Intel H110 Express Chipset

Based Mini-ITX M/B

NO. G03-NF693-F

Revision: 3.0

Release date: July 19, 2017

Trademark:

* Specifications and Information contained in this documentation are furnished for information use only, and are subject to change at any time without notice, and should not be construed as a commitment by manufacturer.

Environmental Protection Announcement

Do not dispose this electronic device into the trash while discarding. To minimize pollution and ensure environment protection of mother earth, please recycle.



TABLE OF CONTENT

ENVIRONMENTAL SAFETY INSTRUCTION.....	iii
USER'S NOTICE	iv
MANUAL REVISION INFORMATION.....	iv
ITEM CHECKLIST	iv
CHAPTER 1 INTRODUCTION OF THE MOTHERBOARD	
1-1 FEATURE OF MOTHERBOARD.....	1
1-2 SPECIFICATION	2
1-3 LAYOUT DIAGRAM.....	3
CHAPTER 2 HARDWARE INSTALLATION	
2-1 JUMPER SETTING	8
2-2 CONNECTORS AND HEADERS.....	13
2-2-1 CONNECTORS	13
2-2-2 HEADERS	18
CHAPTER 3 INTRODUCING BIOS	
3-1 ENTERING SETUP	24
3-2 BIOS MENU SCREEN	25
3-3 FUNCTION KEYS	25
3-4 GETTING HELP	26
3-5 MENU BARS	26
3-6 MAIN MENU	27
3-7 ADVANCED MENU.....	28
3-8 CHIPSET MENU.....	39
3-9 SECURITY MENU	42
3-10 BOOT MENU.....	43
3-11 SAVE & EXIT MENU	44



Environmental Safety Instruction

- Avoid the dusty, humidity and temperature extremes. Do not place the product in any area where it may become wet.
- 0 to 40 centigrade is the suitable temperature. (The temperature comes from the request of the chassis and thermal solution)
- Generally speaking, dramatic changes in temperature may lead to contact malfunction and crackles due to constant thermal expansion and contraction from the welding spots' that connect components and PCB. Computer should go through an adaptive phase before it boots when it is moved from a cold environment to a warmer one to avoid condensation phenomenon. These water drops attached on PCB or the surface of the components can bring about phenomena as minor as computer instability resulted from corrosion and oxidation from components and PCB or as major as short circuit that can burn the components. Suggest starting the computer until the temperature goes up.
- The increasing temperature of the capacitor may decrease the life of computer. Using the close case may decrease the life of other device because the higher temperature in the inner of the case.
- Attention to the heat sink when you over-clocking. The higher temperature may decrease the life of the device and burned the capacitor.

USER'S NOTICE

COPYRIGHT OF THIS MANUAL BELONGS TO THE MANUFACTURER. NO PART OF THIS MANUAL, INCLUDING THE PRODUCTS AND SOFTWARE DESCRIBED IN IT MAY BE REPRODUCED, TRANSMITTED OR TRANSLATED INTO ANY LANGUAGE IN ANY FORM OR BY ANY MEANS WITHOUT WRITTEN PERMISSION OF THE MANUFACTURER.

THIS MANUAL CONTAINS ALL INFORMATION REQUIRED TO USE THIS MOTHER-BOARD SERIES AND WE DO ASSURE THIS MANUAL MEETS USER'S REQUIREMENT BUT WILL CHANGE, CORRECT ANY TIME WITHOUT NOTICE. MANUFACTURER PROVIDES THIS MANUAL "AS IS" WITHOUT WARRANTY OF ANY KIND, AND WILL NOT BE LIABLE FOR ANY INDIRECT, SPECIAL, INCIDENTAL OR CONSEQUENTIAL DAMAGES (INCLUDING DAMAGES FOR LOSS OF PROFIT, LOSS OF BUSINESS, LOSS OF USE OF DATA, INTERRUPTION OF BUSINESS AND THE LIKE).

PRODUCTS AND CORPORATE NAMES APPEARING IN THIS MANUAL MAY OR MAY NOT BE REGISTERED TRADEMARKS OR COPYRIGHTS OF THEIR RESPECTIVE COMPANIES, AND THEY ARE USED ONLY FOR IDENTIFICATION OR EXPLANATION AND TO THE OWNER'S BENEFIT, WITHOUT INTENT TO INFRINGE.

Manual Revision Information

Reversion	Revision History	Date
2.0	Second Edition	November 17, 2016
3.0	Third Edition	July 19, 2017

Item Checklist

- Motherboard
- DVD for motherboard utilities
- User's Manual
- Cable(s)
- I/O Back panel shield

Chapter 1

Introduction of the Motherboard

1-1 Feature of Motherboard

- Intel® H110 express chipset
- Support LGA 1151 CPU socket Intel® Core™ i7 processors / Intel® Core™ i5 processors / Intel® Core™ i3 processors / Intel® Pentium™ processors , Intel® Celeron™ processors (TDP ≤65 W).
- Support 2* DDR4 2133MHz SO-DIMM up to 32GB and dual channel function
- Integrated with 2* Realtek Gigabit Ethernet LAN chip
- Integrated with RealTek ALC662-VD-GR 6-channel HD Audio Codec
- Support USB 3.0 data transport demand
- Support 2 * SATAIII (6Gb/s) Devices
- Support 1* Display port & 1* HDMI port
- Support 1* PCIE 2.0 x16 slot
- Support 1* full-size Mini-PCIE/MSATA slot
- Support 1* M.2 Socket 3 slot for M-key type 2242/2260 SATA SSD
- Support Smart FAN function
- Supports ACPI S3 Function
- Compliance with ErP Standard
- Support Watchdog Timer Technology

1-2 Specification

Spec	Description
Design	<ul style="list-style-type: none"> ● Mini-ITX form factor 6 layers; PCB size: 17.0x17.0cm
Chipset	<ul style="list-style-type: none"> ● Intel H110 Express Chipset
CPU Socket	<ul style="list-style-type: none"> ● Support Intel® LGA 1151 Socket Core™ i7 processors, Intel® Core™ i5 processors, Intel® Core™ i3 processors, Intel® Pentium™ processors, Intel® Celeron™ processors <p><i>* for detailed CPU support information please visit our website</i></p>
Memory Slot	<ul style="list-style-type: none"> ● 2*DDR4 SO-DIMM slot ● Support DDR4 2133 MHz SO-DIMM up to 32GB ● Support dual channel function
Expansion Slot	<ul style="list-style-type: none"> ● 1* PCIE x 16 slot ● 1* Full-size Mini-PCIE/ MSATA shared slot (MPE1)
Storage	<ul style="list-style-type: none"> ● 2* SATA III 6G/s connector ● 1 * full-size Mini-PCIE/ MSATA shared slot (MPE1) ● 1* M.2 Socket 3 slot (M-key, support type 2242/2260 SATA SSD)
Gigabit LAN Chip	<ul style="list-style-type: none"> ● Integrated with 2* Realtek RTL8111G Gigabit PCI-E LAN chip ● Support Fast Ethernet LAN function of providing 10/100/1000Mbps Ethernet data transfer rate
Audio Chip	<ul style="list-style-type: none"> ● Realtek ALC662-VD-GR 5.1 channel Audio Codec integrated ● Audio driver and utility included
BIOS	<ul style="list-style-type: none"> ● AMI 64Mb Flash ROM
Multi I/O	<p>Rear Panel I/O:</p> <ul style="list-style-type: none"> ● 4* Serial port connector(COM1_COM2/COM3_COM4, <i>COM1 supports RS232/422/485 function</i>) ● 1* Display port ● 1* HDMI port ● 4* USB 3.0 port

- 2* RJ-45 LAN port
- 1*3-jack audio connector (Line-in, Line-out, MIC)
- Internal I/O Connectors & Headers:**
- 1 *24-pin main power connector
- 1 * 4-pin 12V power connector
- 1* CPUFAN connector & 1* SYSFAN connector
- 1*Front panel audio header
- 1* SPDIF-out header
- 1*Front panel header
- 2 * 9-Pin USB 2.0/1.1 header for 4* USB 2.0/1.1 ports
- 1 * PS2 Keyboard & Mouse header
- 1* SMBUS header
- 1* GPIO header
- 2* Serial port header (**COM5/6**, COM5 is optional to support RS232/422/485)
- 1* Jumper & Header Combo Block (**JP1**)
- 1* EDP connector

1-3 Layout Diagram

Rear IO Diagram

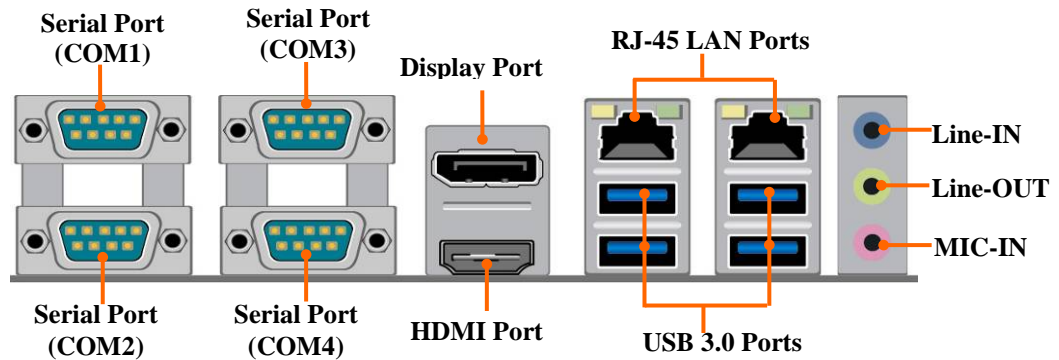

Motherboard Internal Diagram-Front

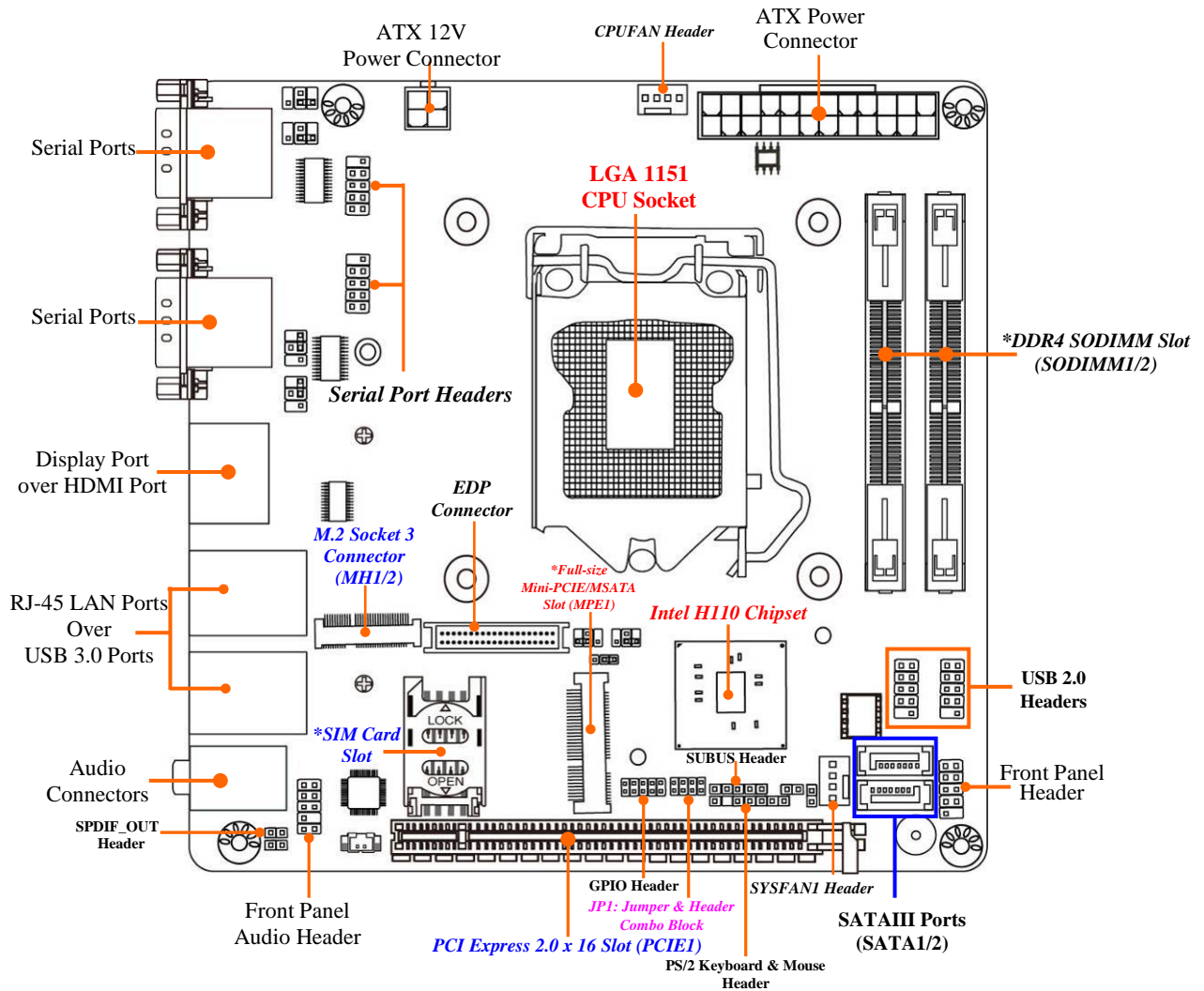

Note: SIM card slot only work when compatible SIM card installed & 3G LAN card installed in MPE1 Mini-PCIE slot.

Motherboard Jumper Position

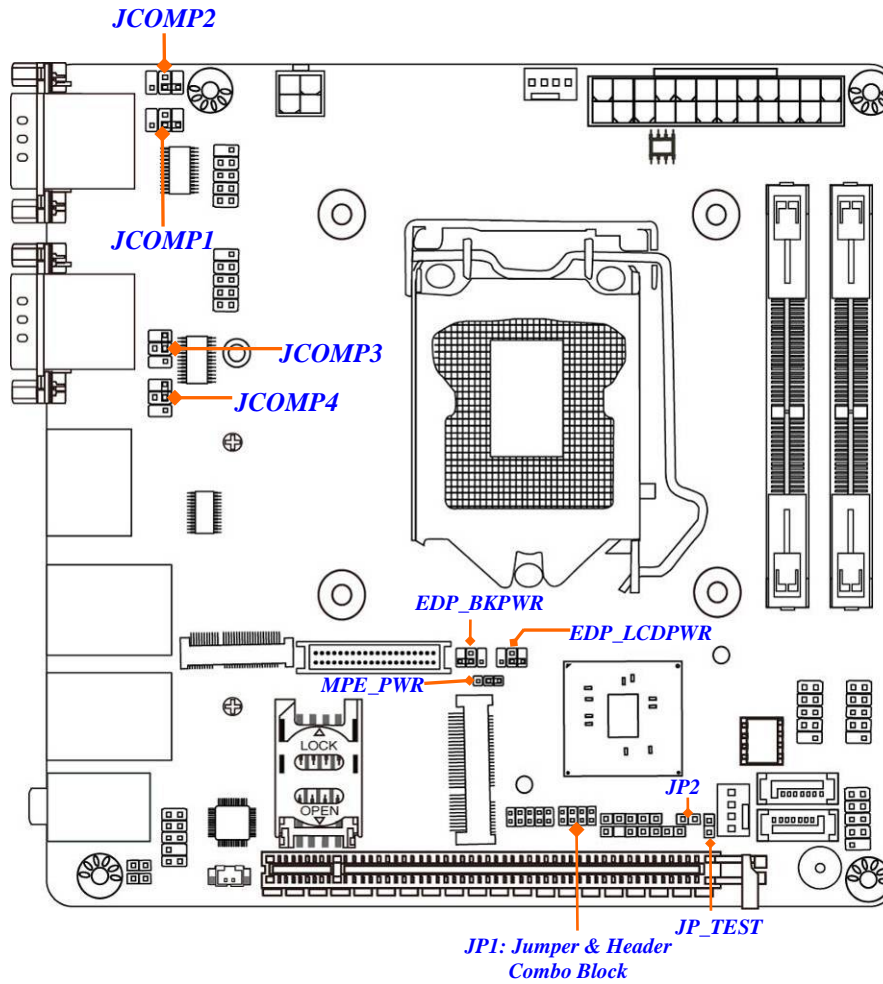

Connectors

Connector	Name
ATXPWR1	24-Pin ATX Main Power Connector
ATX12V1	4-Pin 12V Power Connector
COM1_COM2/COM3_COM4	Serial Port COM Connector X4
DP_HDMI1	Top: Display Port Connector Bottom: HDMI Port Connector
UL1/UL2	Top: RJ-45 LAN Connector X2 Middle & Bottom: USB 3.0 Port Connector X4
AUDIO1	Top: Line-in Connector Middle: Line-out Connector Bottom: MIC Connector
SATA1/2	SATAIII Connector
EDP	EDP Connector
SYSFAN,CPUFAN	FAN Connector X2

Headers

Header	Name	Description
FP_AUDIO1	Front Panel Audio Header	9-pin Block
SPDIFOUT1	HDMI_SPDIF Out Header	2-pin Block
FP1	Front Panel Header(PWR LED/ HD LED/Power Button /Reset)	9-pin Block
USB1/2	USB Header X2	9-pin Block
PS2KBMS	PS2 Keyboard & Mouse Header	6-pin Block
SMBUS	SMBUS Header	5-pin Block
GPIO1	GPIO Header	10-pin Block
JP1	Pin(5&6): LAN1 Activity LED Header Pin(7&8): LAN2 Activity LED Header	8-pin Block
COM5/6	Serial Port Header	9-pin Block

Jumper

Jumper	Name	Description
JCOMP1	COM1 Port Pin9 Function Select	4-pin Block
JCOMP2	COM2 Port Pin9 Function Select	4-pin Block
JCOMP3	COM3 Port Pin9 Function Select	4-pin Block
JCOMP4	COM4 Port Pin9 Function Select	4-pin Block
JBAT	Clear CMOS RAM Settings	2-pin Block
JP2	ME_Features Select	2-pin Block
MPE_PWR	MPE1 Slot MPE_PWR VCC 3.3V/3.3VSB Select	3-pin Block
JP1	<i>Pin(1-2):</i> Case Open Message Display Function <i>Pin(3-4):</i> ATX Mode / AT Mode Select	8-pin Block
EDP_BKPWR	EDP Backlight VCC 3.3V/5V/12V Select	4-pin Block
EDP_LCDPWR	EDP Panel Backlight VCC 3.3V/5V/12V Select	4-pin Block

Chapter 2

Hardware Installation

2-1 Jumper Setting

JCOMP1 (4-pin): COM1 Port Pin9 Function Select

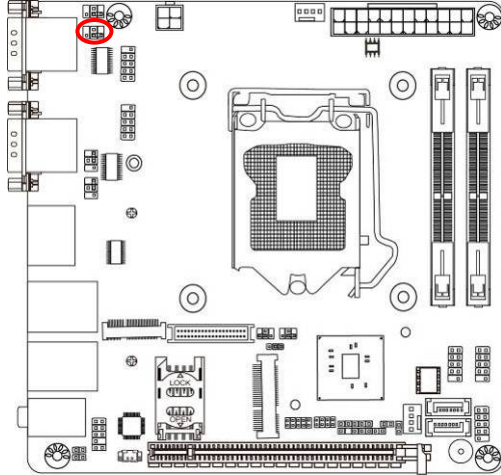

JCOMP1 → COM1 Port Pin-9

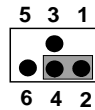

2-4 Closed:
Pin9=RING;

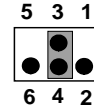

3-4 Closed:
Pin9=5V;

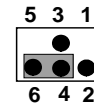

4-6 Closed:
Pin9=12V.

JCOMP2 (4-pin): COM2 Port Pin9 Function Select

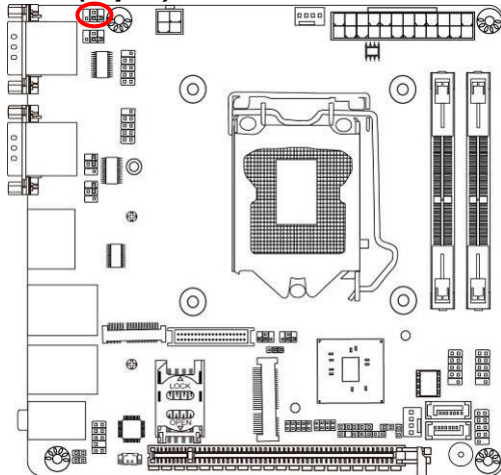

JCOMP2 → COM2 Port Pin-9

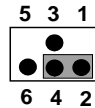

2-4 Closed:
Pin9=RING;

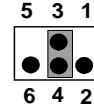

3-4 Closed:
Pin9=5V;

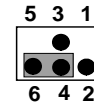

4-6 Closed:
Pin9=12V.

JCOMP3 (4-pin): COM3 Port Pin9 Function Select

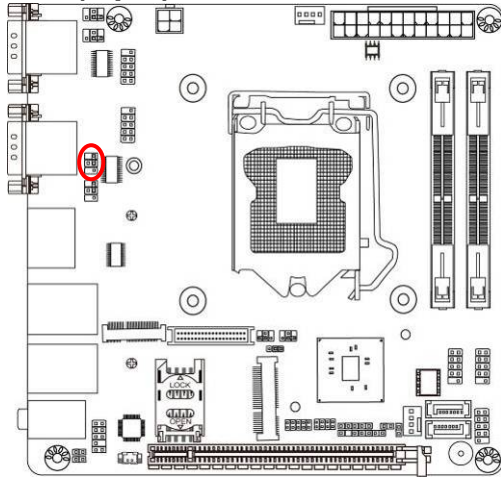

JCOMP3 → COM3 Port Pin-9

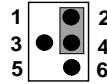

2-4 Closed:
Pin9=RING;

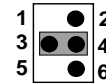

3-4 Closed:
Pin9=5V;

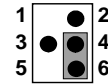

4-6 Closed:
Pin9=12V.

JCOMP4 (4-pin): COM4 Port Pin9 Function Select

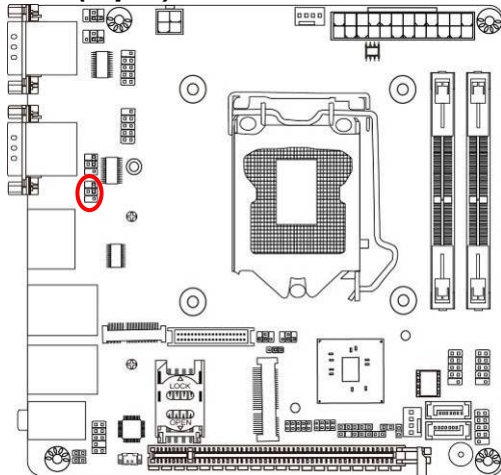

JCOMP4 → COM4 Port Pin-9

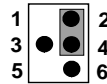

2-4 Closed:
Pin9=RING;

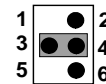

3-4 Closed:
Pin9=5V;

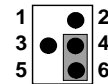

4-6 Closed:
Pin9=12V.

JBAT (2-pin): Clear CMOS RAM Settings

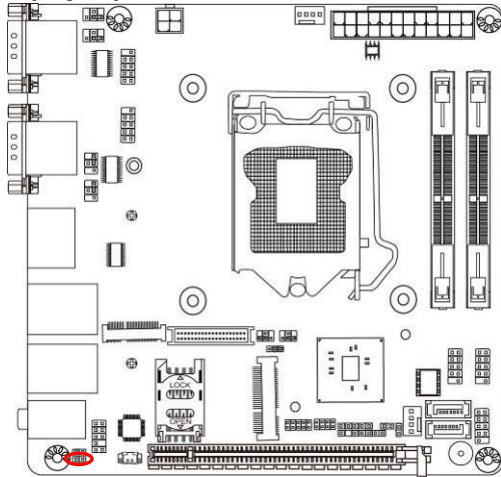

JBAT → Clear CMOS



1-2 Open: Normal (Default);



1-2 Closed: Clear CMOS Settings.

JP2 (2-pin): ME Features Select

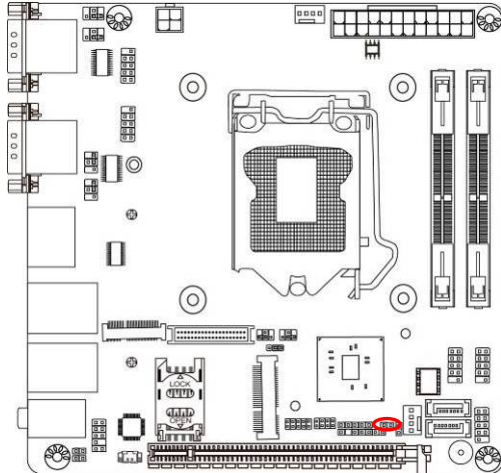

JP2 → ME Features Select



1-2 Open: Enable ME Features;



1-2 Closed: Disable ME Features.

MPE_PWR (3-pin): MPE1 Slot VCC 3.3V/3.3 VSB Select

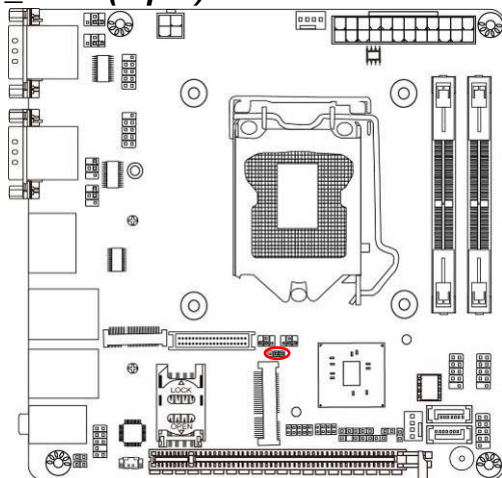

MPE_PWR → MPE1 Slot VCC

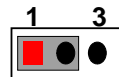

1-2 Closed: MPE1 Slot VCC= 3.3V;

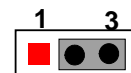

2-3 Closed: MPE1 Slot VCC= 3.3VSB.

Pin (1-2) of JP1 (8-pin): Case Open Message Display Function Select

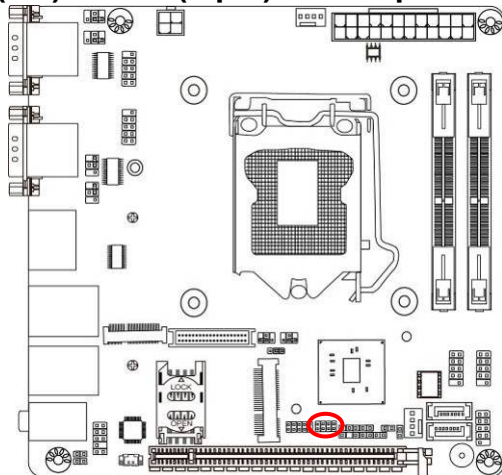

Pin(1-2) of JP1 → Case Open Detect

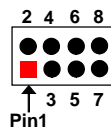

1-2 Open: Normal (Default);

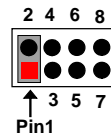

1-2 Close: Case Open Detect Function Selected.

Pin (1-2) Close: When Case open function pin short to GND, the Case open function was detected. When Used, needs to enter BIOS and enable 'Case Open Detect' function. In this case if your case is removed, next time when you restart your computer, a message will be displayed on screen to inform you of this.

Pin (3-4) of JP1 (8-pin): ATX Mode/ AT Mode Select

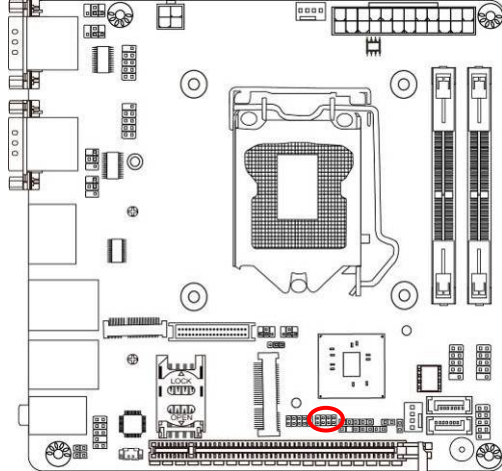

Pin(3-4) of JP7→ATX/AT Mode Select

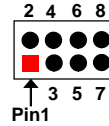

3-4 Open: ATX Mode Selected (Default);

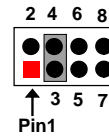

3-4 Close : AT Mode Selected.

***ATX Mode Selected:** Press power button to power on after power input ready;
AT Mode Selected: Directly power on as power input ready.

EDP_BKPWR (4-pin): EDP Backlight VCC 3.3V/5V/12V

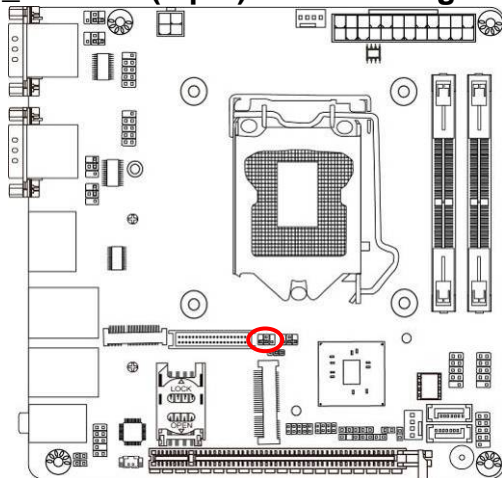

EDP_BKPWR→EDP Backlight VCC

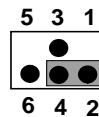

2-4 Closed:
EDP Backlight
VCC =3.3V;

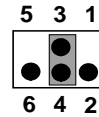

3-4 Closed:
EDP Backlight
VCC =5V;

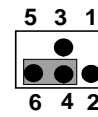

4-6 Closed:
EDP Backlight
VCC =12V;

EDP_LCDPWR (4-pin): EDP LCD Panel VCC 3.3V/5V/12V

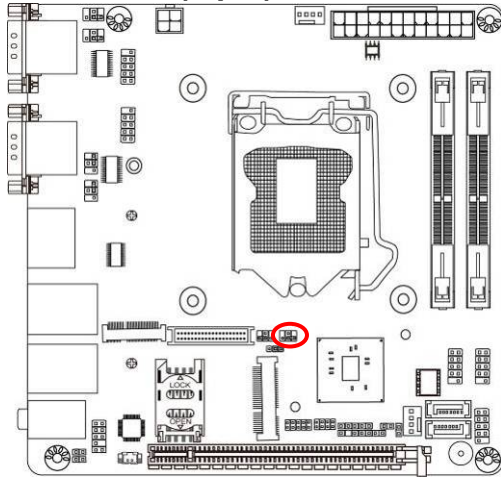

EDP_LCDPWR → EDP LCD Panel VCC

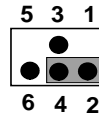

2-4 Closed:
EDP LCD
VCC =3.3V;

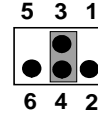

3-4 Closed:
EDP LCD
VCC =5V;

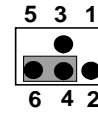





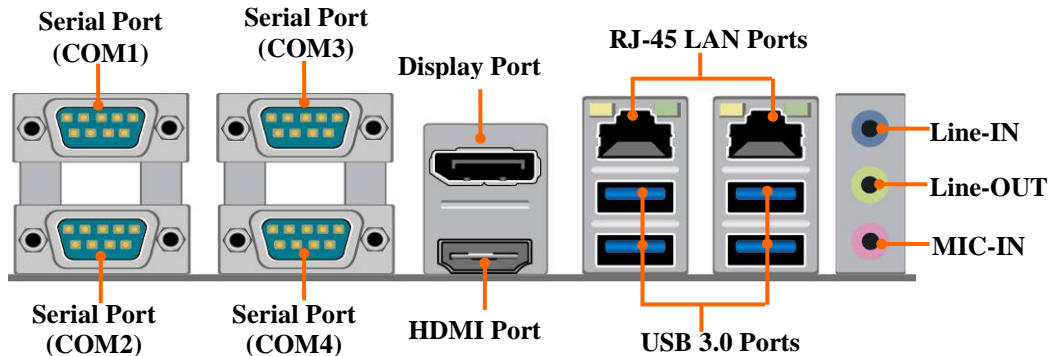

4-6 Closed:
EDP LCD
VCC =12V;

2-2 Connectors and Headers

2-2-1 Connectors

(1) Rear Panel Connectors



Icon	Name	Function
	Serial Port	Mainly for user to connect external MODEM or other devices that supports Serial Communications Interface. <i>*Note: COM1 supports RS232/422/485 function.</i>
	Display Port	To the system to corresponding display device with compatible display port cable.
	HDMI Port	To connect display device that support HDMI specification.
	RJ-45 LAN Port	This connector is standard RJ-45 LAN jack for Network connection.
	USB 3.0 Port	To connect USB keyboard, mouse or other devices compatible with USB specification. USB 3.0 ports supports up to 5Gbps data transfer rate.
	Audio Connectors	BLUE: Line-in Connector GREEN: Line-out Connector PINK : MIC Connector

(2) COM1 (9-pin Block): RS232/422/485 Port

COM1 port can function as RS232/422/485 port. In normal settings COM1 functions as RS232 port. With compatible COM cable COM1 can function as RS422 or RS 485 port. User also needs to go to BIOS to set '**Transmission Mode Select**' for COM1 at first, before using specialized cable to connect different pins of this port.

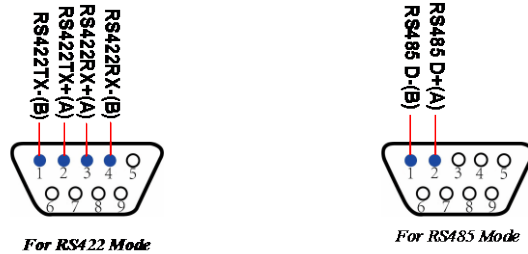

(3) ATXPWR1 (24-pin block): Power Connector

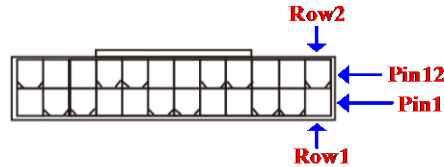
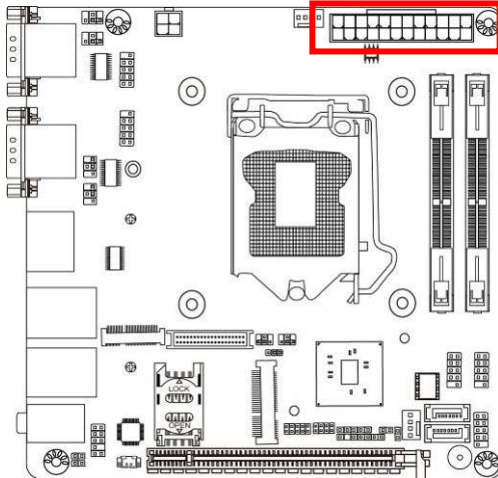

PIN	ROW1	ROW2
1	+3.3V	+3.3V
2	+3.3V	-12V
3	GND	GND
4	+5V	Soft Power on
5	GND	GND
6	+5V	GND
7	GND	GND
8	Power OK	-5V
9	+5V Stand by	+5V
10	+12V	+5V
11	+12V	+5V
12	+3.3V	GND

(4) ATX12V1 (4-pin block): ATX12V Type Power Connector

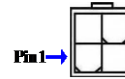
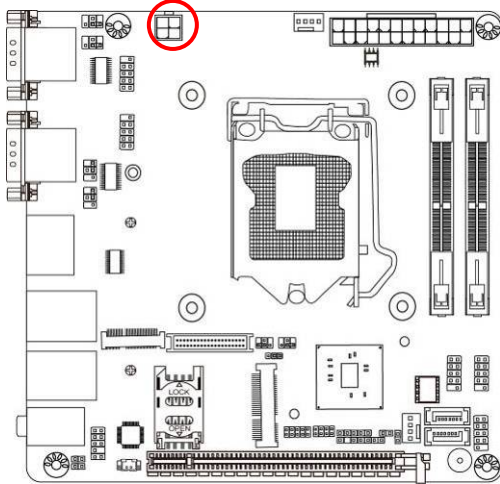

Pin No.	Definition
1	GND
2	GND
3	+12V
4	+12V

(5) SATA1/SATA2 (7-pin): SATA III Port connector

SATA1&SATA2 are high-speed SATAIII port that supports 6 GB/s transfer rate.

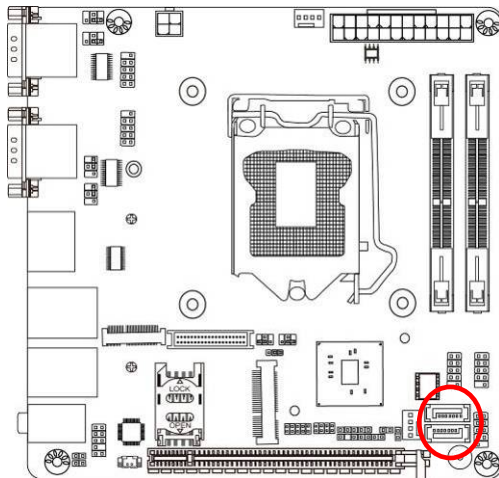

Pin No.	Definition
1	GND
2	TXP
3	TXN
4	GND
5	RXN
6	RXP
7	GND



(6) EDP(40-pin): EDP Connector

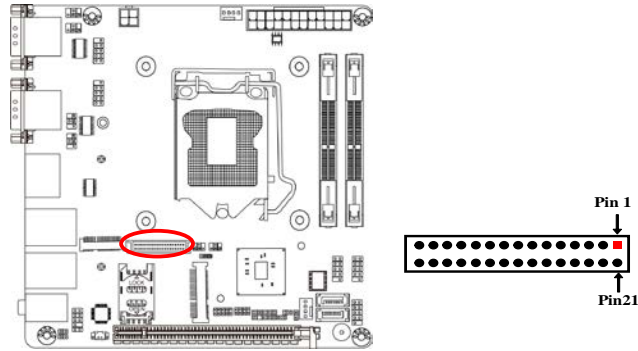

Pin No.	Pin Define	Pin No.	Pin Define
Pin 1	NC	Pin 21	NC
Pin 2	GND	Pin 22	NC
Pin 3	EDP_DATA3N	Pin 23	GND
Pin 4	EDP_DATA3P	Pin 24	GND
Pin 5	GND	Pin 25	GND
Pin 6	EDP_DATA2N	Pin 26	GND
Pin 7	EDP_DATA2P	Pin 27	EDP_HPD
Pin 8	GND	Pin 28	GND
Pin 9	EDP_DATA1N	Pin 29	GND
Pin 10	EDP_DATA1P	Pin 30	GND
Pin 11	GND	Pin 31	GND
Pin 12	EDP_DATA0N	Pin 32	LCD_BKLT_EN
Pin 13	EDP_DATA0P	Pin 33	LCD_BKLT_PWM
Pin 14	GND	Pin 34	Option
Pin 15	EDP_AUXP	Pin 35	NC
Pin 16	EDP_AUXN	Pin 36	LCD_BKLT_PWR
Pin 17	GND	Pin 37	LCD_BKLT_PWR
Pin 18	LCD_VCC	Pin 38	LCD_BKLT_PWR
Pin 19	LCD_VCC	Pin 39	LCD_BKLT_PWR
Pin 20	LCD_VCC	Pin 40	NC

(7) CPUFAN/SYSFAN (4-pin): Fan Connector

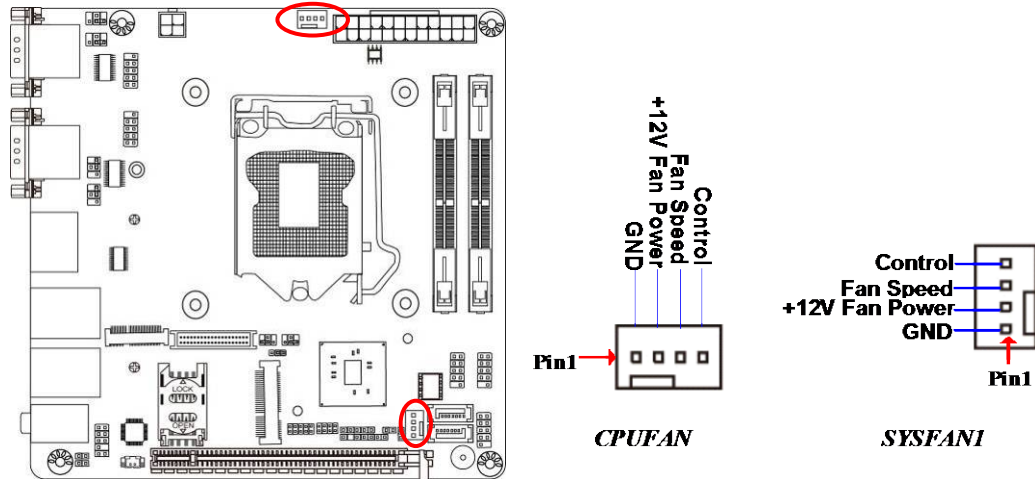

2-2-2 Headers

(1) FP_AUDIO1 (9-pin): Line-Out, MIC-In Header

This header connects to Front Panel Line-out, MIC-In connector with cable.

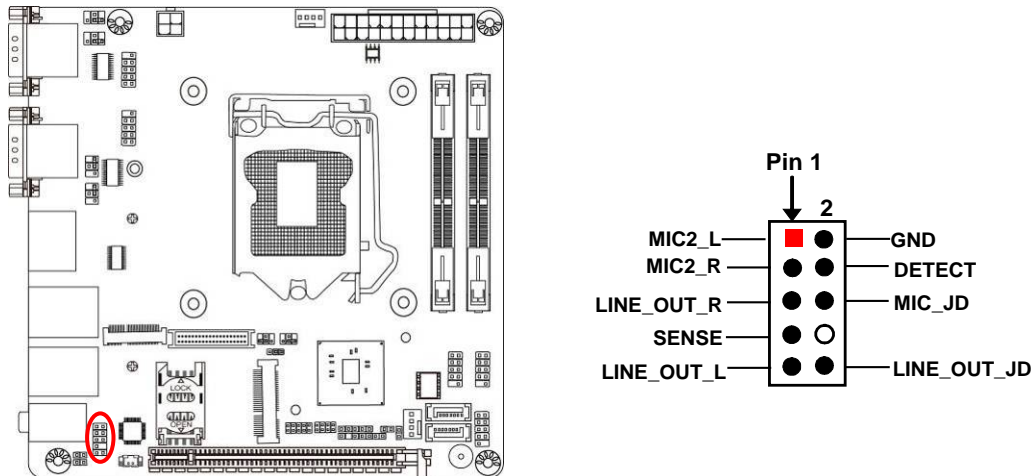

(2) SPDIFOUT1 (2-pin): HDMI-SPDIF Out header

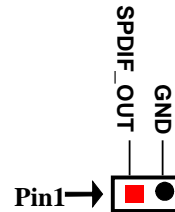
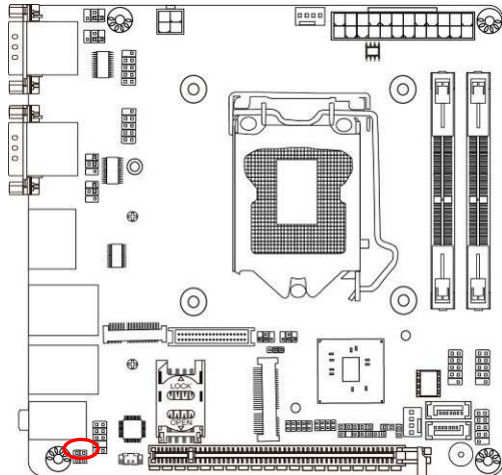

(3) FP1 (9-pin): Front Panel Header

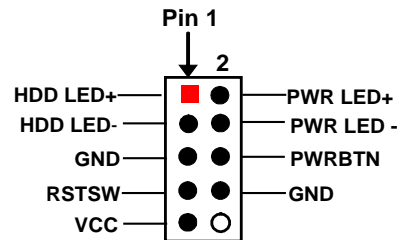
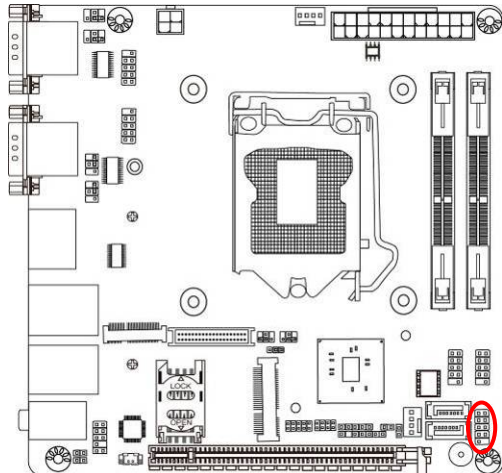

(4) USB1/USB2 (9-pin): USB 2.0 Port Headers

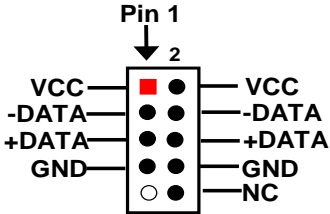
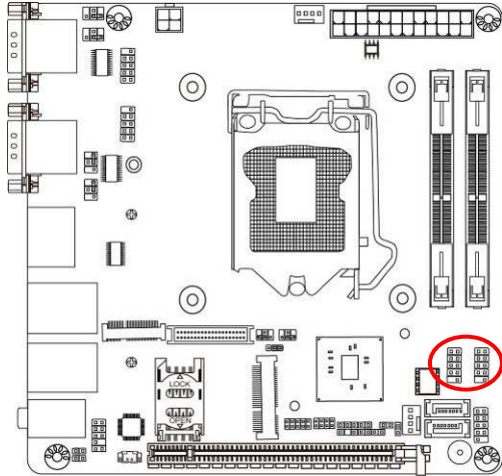

(5) PS2KBMS (6-pin): PS/2 Keyboard & Mouse Header

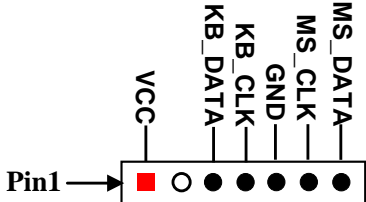
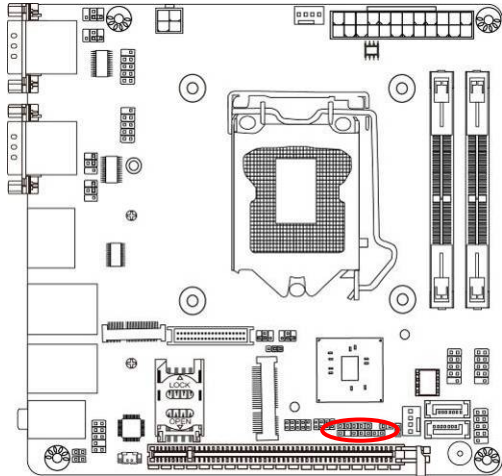

(6) SMBUS (4-Pin): SMBUS Header

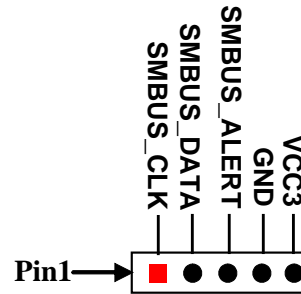
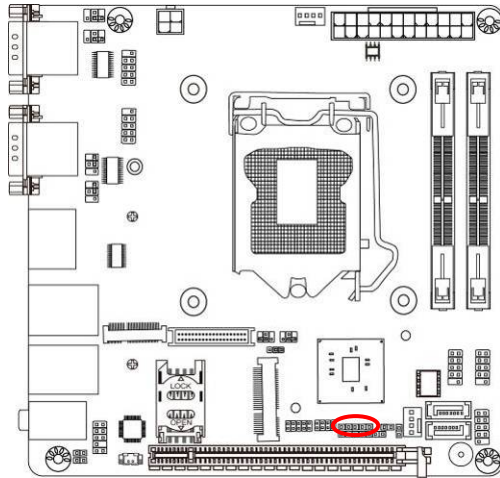

(7) GPIO1(10-pin): GPIO Header

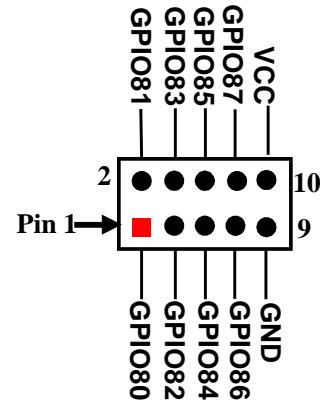
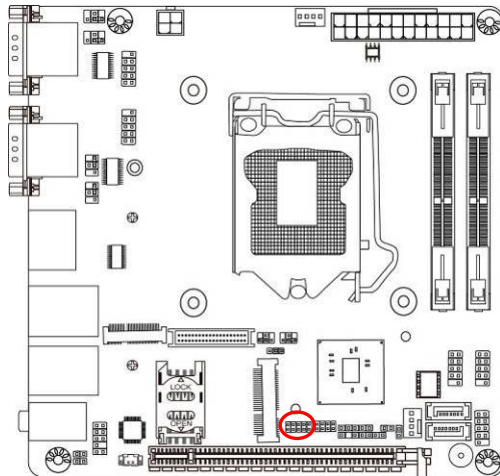

(8) COM5/COM6 (9-pin): RS232(/422/485) Serial Port Header

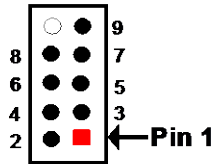
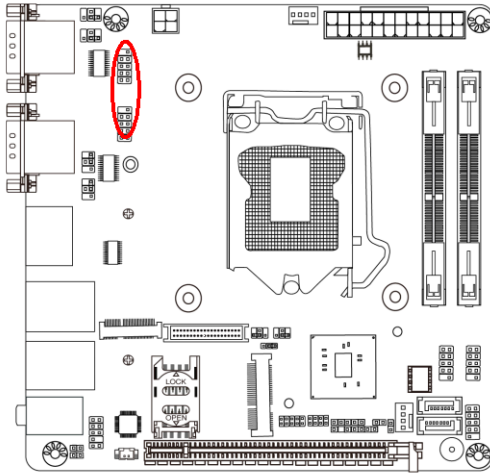

Pin NO.	RS232	*RS422 (COM5)	*RS485 (COM5)
Pin 1	DCD	TX-	DATA-
Pin 2	DSR	NC	NC
Pin 3	RXD	TX+	DATA+
Pin 4	RTS	NC	NC
Pin 5	TXD	RX+	NC
Pin 6	CTS	NC	NC
Pin 7	DTR	RX-	NC
Pin 8	RI	NC	NC
Pin 9	GND	GND	GND

COM5 is optional to support RS232/422/485 function.

COM6 only supports RS232 function.

***Notice:** COM5 servers as RS232 serial port header in most cases. RS422 & RS485 function is only optional to customized models. User also needs to go to BIOS to set '**Transmission Mode Select**' for **COM5** as [RS422] or [RS485] (only supported by customized BIOS version)for boards that support RS422/485 function before connecting compatible COM cable to **COM5** header.

(9) Pin(5-6) & Pin(7-8) of JP1 (8-pin): LAN Activity LED Headers

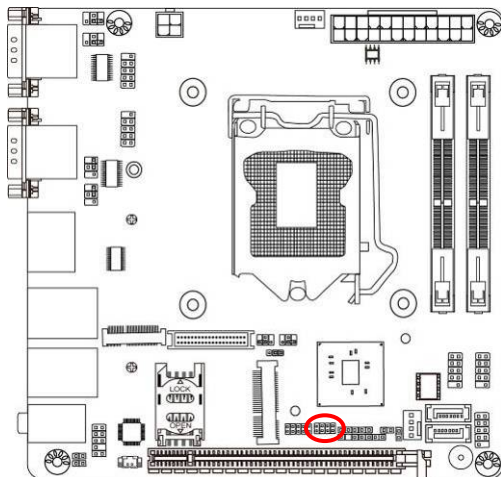

JP1: Pin(5-6)→LAN1 Activity LED
JP1: Pin(7-8)→LAN2 Activity LED

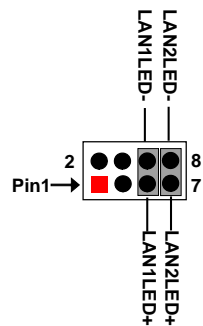

Chapter 3

Introducing BIOS

Notice! The BIOS options in this manual are for reference only. Different configurations may lead to difference in BIOS screen and BIOS screens in manuals are usually the first BIOS version when the board is released and may be different from your purchased motherboard. Users are welcome to download the latest BIOS version form our official website.

The BIOS is a program located on a Flash Memory on the motherboard. This program is a bridge between motherboard and operating system. When you start the computer, the BIOS program will gain control. The BIOS first operates an auto-diagnostic test called POST (power on self test) for all the necessary hardware, it detects the entire hardware device and configures the parameters of the hardware synchronization. Only when these tasks are completed done it gives up control of the computer to operating system (OS). Since the BIOS is the only channel for hardware and software to communicate, it is the key factor for system stability, and in ensuring that your system performance as its best.

3-1 Entering Setup

Power on the computer and by pressing immediately allows you to enter Setup. If the message disappears before your respond and you still wish to enter Setup, restart the system to try again by turning it OFF then ON or pressing the “RESET” button on the system case. You may also restart by simultaneously pressing <Ctrl>, <Alt> and <Delete> keys. If you do not press the keys at the correct time and the system does not boot, an error message will be displayed and you will again be asked to

Press **** to enter Setup

3-2 BIOS Menu Screen

The following diagram show a general BIOS menu screen:

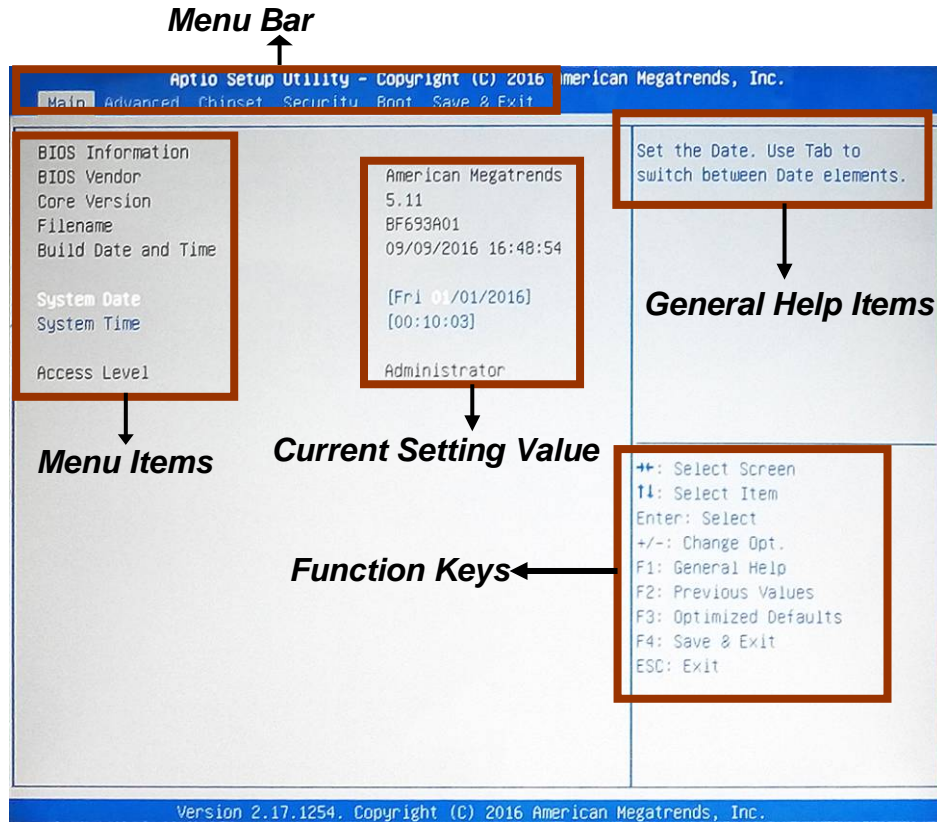

BIOS Menu Screen

3-3 Function Keys

In the above BIOS Setup main menu of, you can see several options. We will explain these options step by step in the following pages of this chapter, but let us first see a short description of the function keys you may use here:

- Press←→ (left, right) to select screen;

-
-
- Press ↑↓ (up, down) to choose, in the main menu, the option you want to confirm or to modify.
 - Press <Enter> to select.
 - Press <+>/<-> keys when you want to modify the BIOS parameters for the active option.
 - [F1]: General help.
 - [F2]: Previous values.
 - [F3]: Optimized defaults.
 - [F4]: Save & Exit.
 - Press <Esc> to exit from BIOS Setup.

3-4 Getting Help

Main Menu

The on-line description of the highlighted setup function is displayed at the top right corner the screen.

Status Page Setup Menu/Option Page Setup Menu

Press F1 to pop up a small help window that describes the appropriate keys to use and the possible selections for the highlighted item. To exit the Help Window, press <Esc>.

3-5 Menu Bars

There are six menu bars on top of BIOS screen:

Main	To change system basic configuration
Advanced	To change system advanced configuration
Chipset	To change chipset configuration
Security	Password settings
Boot	To change boot settings
Save & Exit	Save setting, loading and exit options.

User can press the right or left arrow key on the keyboard to switch from menu bar. The selected one is highlighted.

3-6 Main Menu

Main menu screen includes some basic system information. Highlight the item and then use the <+> or <-> and numerical keyboard keys to select the value you want in each item.

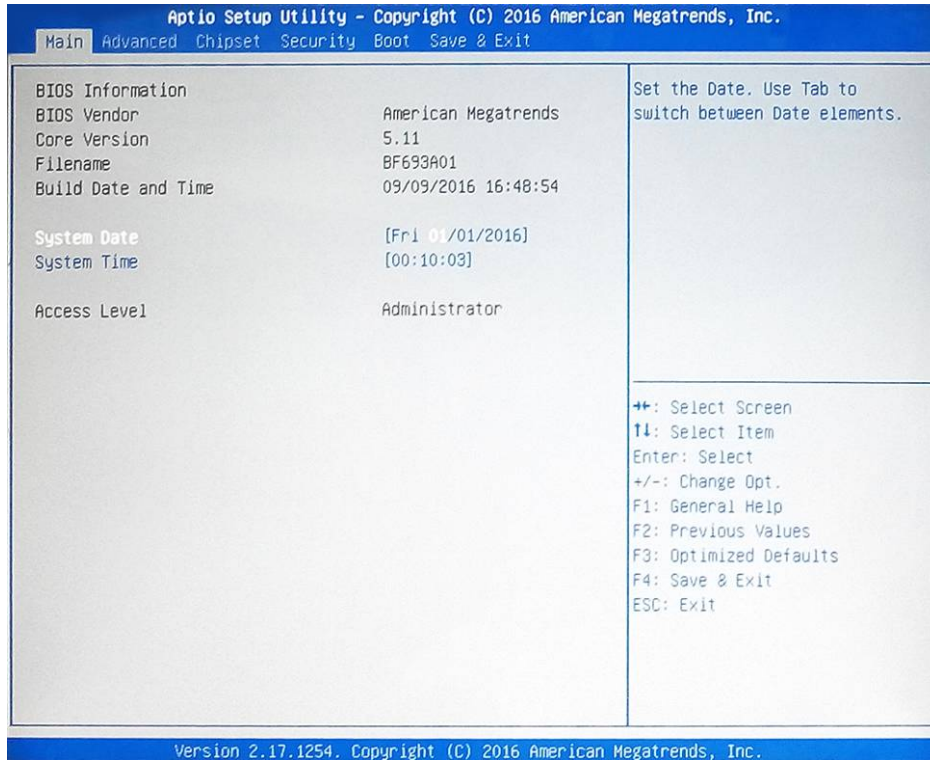

System Date

Set the date. Please use [Tab] to switch between data elements.

System Time

Set the time. Please use [Tab] to switch between time elements.

3-7 Advanced Menu

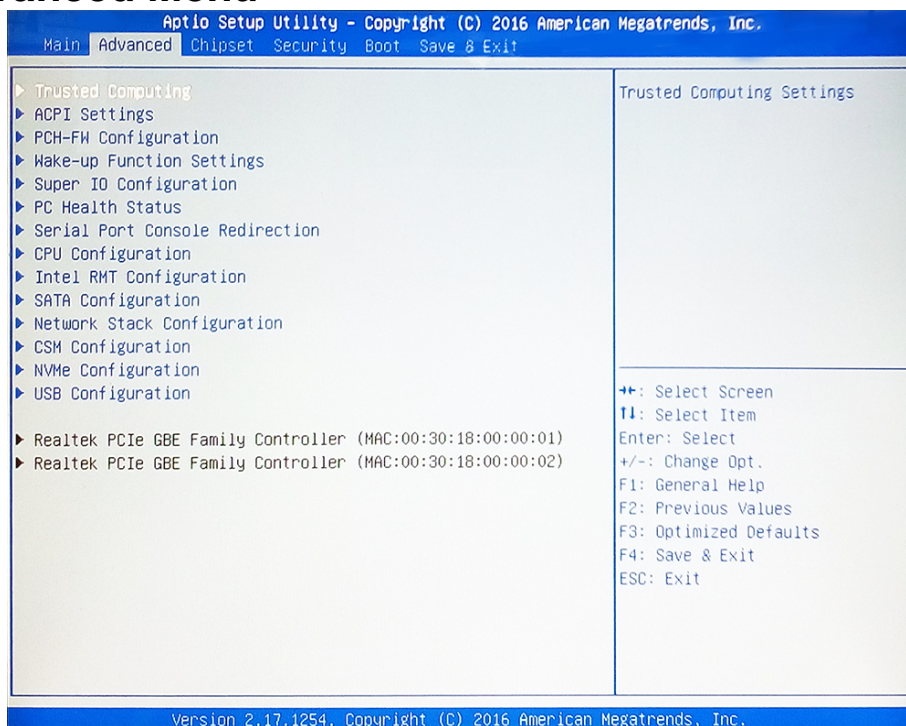

▶ **Trusted Computing**

Press [Enter] to enable or disable '**Security Device Support**'.

Security Device Support

Use this item to enable or disable BIOS support for security device.

The optional settings: [Disabled]; [Enabled].

When set as **[Enabled], user can make further settings in the following items:*

TPM State

Use this item to enable or disable security device. Your computer will reboot during restart to change state of device.

The optional settings: [Disabled]; [Enabled].

Pending Operation

Use this item to schedule an operation for the security device. Your computer will

reboot during restart to change state of device.
The optional settings: [None]; [TPM Clear].

▶ **ACPI Settings**

Press [Enter] to make settings for the following sub-items:

ACPI Settings

ACPI Sleep State

Use this item to select the highest ACPI sleep state the system will enter when the suspend button is pressed.

The optional settings are: [Suspend Disabled]; [S3 (Suspend to RAM)].

▶ **PCH-FW Configuration**

Press [Enter] to view ME information and make settings in the following sub-items:

TPM Device Selection

Use this item to select TPM device.

The default setting is: [PTT].

[PTT]: Enable PTT in SkuMgr.

▶ **Firmware Update Configuration**

Press [Enter] to make settings for 'ME FW Image RE-Flash'.

ME FW Image Re-Flash

Use this item to enable or disable ME FW Image Re-Flash function.

The optional settings: [Disabled]; [Enabled].

** In the case that user needs to update ME firmware, user should set 'ME FW Image Re-Flash' as [Enabled], save the settings and exit. The system will turn off and reboot after 4 seconds. If the user goes to BIOS screen again will find this item is set again as [Disabled], but user can still re-flash to update firmware next time.*

▶ **Wake-up Function Settings**

Press [Enter] to make settings for the following sub-items:

Wake-up System with Fixed Time

Use this item to enable or disable system wake on alarm event.

The optional settings: [Disabled]; [Enabled].

When set as [Enabled], system will wake on the hour/min/sec specified.

Wake-up System with Dynamic Time

Use this item to enable or disable system wake on alarm event.

System will wake on the current time + Increase minutes.

The optional settings: [Disabled]; [Enabled].

When set as [Enabled], system will wake on the current time + increased minute(s).

PS2 KB/MS Wake-up

The optional settings: [Enabled]; [Disabled].

Use this item to enable or disable PS2 KB/MS wake-up from S3/S4/S5.

****Note:** *This function is supported when 'ERP Support' is set as [Disabled].*

USB S3/S4 Wake-up

Use this item to enable or disable USB S3/S4 wakeup. This function is only supported when ERP function is disabled.

****Note:** *This function is supported when 'ERP Support' is set as [Disabled].*

USB S5 Power

Use this item to enable or disable USB power after power shutdown.

**This function is supported when 'ERP Support' is set as [Disabled].*

Ring Wake-up

The optional settings: [Enabled]; [Disabled].

Use this item to enable or disable ring wake-up.

****Note:** *This function is supported when 'ERP Support' is set as [Disabled].*

▶ **Super I/O Configuration**

Press [Enter] to make settings for the following sub-items:

Super IO Configuration

ERP Support

The optional settings: [Disabled]; [Auto].

This item should be set as [**Disabled**] if you wish to have all active wake-up functions.

▶ **Serial Port 1 Configuration**

Press [Enter] to make settings for the following items:

Serial Port

Use this item to enable or disable serial port (COM).

Change Settings

Use this item to select an optimal setting for super IO device.

Transmission Mode Select

The optional settings are: [RS422]; [RS232]; [RS485].

Mode Speed Select

The optional settings are: [RS232/RS422/RS485=250kbps]; [RS232=1Mbps, RS422/RS485=10Mbps].

Serial Port FIFO Mode

The optional settings are: [16-Byte FIFO]; [32-Byte FIFO]; [64-Byte FIFO]; [128-Byte FIFO].

▶ **Serial Port 2 Configuration/ Serial Port 3 Configuration/Serial Port 4 Configuration/ Serial Port 5 Configuration/ Serial Port 6 Configuration**

Press [Enter] to make settings for the following sub-items:

Serial Port

Use this item to enable or disable serial port (COM).

Change Settings

Use this item to select an optimal setting for super IO device.

Serial Port FIFO Mode

The optional settings are: [16-Byte FIFO]; [32-Byte FIFO]; [64-Byte FIFO]; [128-Byte FIFO].

WatchDog Reset Timer

Use this item to enable or disable WDT reset function. When set as [Enabled], the following sub-items shall appear:

WatchDog Reset Timer Value

User can set a value in the range of [4] to [255].

WatchDog Reset Timer Unit

The optional settings are: [Sec.]; [Min.].

WatchDog Wake-up Timer in ERP

This item support WDT wake-up while 'ERP Support' is set as [Auto].

The optional settings: [Disabled]; [Enabled].

When set as [Enabled], the following sub-items shall appear:

WatchDog Wake-up Timer Value in ERP

User can select a value in the range of [10] to [4095] seconds when 'WatchDog

Reset Timer Unit set as [Sec]; or in the range of [1] to [4095] minutes when **'WatchDog Reset Timer Unit'** set as [Min].

WatchDog Reset Timer Unit

The optional settings are: [Sec.]; [Min.].

ATX Power Emulate AT Power

This item support Emulate AT power function, MB power On/Off control by power supply. Use needs to select 'AT or ATX Mode' on MB jumper at first (refer to **Page 12**, Pin 3&4 of JP1 block for ATX Mode & AT Mode Select).

Case Open Detect

Use this item to detect case has already open or not, show message in POST.

PS2 KB/MS Connect

The optional settings are: [Keyboard First]; [Mouse First].

▶ **PC Health Status**

Press [Enter] to view current hardware health status, make further settings in **'SmartFAN Configuration'** and set value in **'Shutdown Temperature'**.

▶ **SmartFAN Configuration**

Press [Enter] to make settings for SmartFan Configuration:

SmartFAN Configuration

CPUFAN / SYSFAN1 Smart Mode

The optional settings are: [Disabled]; [Enabled].

When set as [Enabled], the following sub-items shall appear:

CPUFAN / SYSFAN1 Full-Speed Temperature

Use this item to set CPUFAN/SYSFAN full speed temperature. Fan will run at full speed when above this pre-set temperature.

CPUFAN / SYSFAN1 Full-Speed Duty

Use this item to set CPUFAN/SYSFAN full-speed duty. Fan will run at full speed when above this pre-set duty.

CPUFAN / SYSFAN1 Idle-Speed Temperature

Use this item to set CPUFAN /SYSFAN idle speed temperature. Fan will run at idle speed when below this pre-set temperature.

CPUFAN / SYSFAN1 Idle-Speed Duty

Use this item to set CPUFAN/SYSFAN idle speed duty. Fan will run at idle speed when below this pre-set duty.

Shutdown Temperature

Use this item to select system shutdown temperature.

The optional settings are: [Disabled]; [70°C/156°F]; [75°C/164°F]; [80°C/172°F]; [85°C/180°F]; [90°C/188°F].

▶ **Serial Port Console Redirection**

Press [Enter] to make settings for the following sub-items:

COM1

Console Redirection

Use this item to enable or disable COM1 Console Redirection.

The optional settings are: [Disabled]; [Enabled].

*When set as [Enabled], user can make further settings in the ‘**Console Redirection Settings**’ screen:*

▶ **Console Redirection Settings**

The settings specify how the host computer and the remote computer (which the user is using) will exchange data. Both computers should have the same or compatible settings.

Press [Enter] to make settings for the following sub-items:

Terminal Type

The optional settings are: [VT100]; [VT100+]; [VT-UTF8]; [ANSI].

Bits per second

The optional settings are: [9600]; [19200]; [38400]; [57600]; [115200].

Data Bits

The optional settings are: [7]; [8].

Parity

The optional settings are: [None]; [Even]; [Odd]; [Mark]; [Space].

Stop Bits

The optional settings are: [1]; [2].

Flow Control

The optional settings are: [None]; [Hardware RTS/CTS].

VT-UTF8 Combo Key Support

The optional settings are: [Disabled]; [Enabled].

Recorder Mode

The optional settings are: [Disabled]; [Enabled].

Resolution 100x31

The optional settings are:[Disabled]; [Enabled].

Legacy OS Redirection Resolution

The optional settings are: [80x24]; [80x25].

Putty Keypad

The optional settings are: [VT100]; [LINUX]; [XTERMR6]; [SCO]; [ESCN]; [VT400].

Redirection After BIOS POST

The optional settings are: [Always Enable]; [BootLoader].

Serial Port for Out-of-Band Management/

Windows Emergency Management Services (EMS)

Console Redirection

The optional settings: [Disabled]; [Enabled].

*When set as [Enabled], user can make further settings in '**Console Redirection Settings**' screen:*

▶ Console Redirection Settings

The settings specify how the host computer and the remote computer (which the user is using) will exchange data. Both computers should have the same or compatible settings.

Press [Enter] to make settings for the following sub-items.

Out-of-Band Mgmt Port

The optional settings are: [COM1]; [COM1(Pci Bus0, Dev0, Func0) (Disabled)].

Terminal Type

The optional settings are: [VT100]; [VT100+]; [VT-UTF8]; [ANSI].

Bits per second

The optional settings are: [9600]; [19200]; [57600]; [115200].

Flow Control

The optional settings are: [None]; [Hardware RTS/CTS]; [Software Xon/Xoff].

Data Bits

The default setting is: [8].

**This item may or may not show up, depending on different configuration.*

Parity

The default setting is: [None].

**This item may or may not show up, depending on different configuration.*

Stop Bits

The default setting is: [1].

**This item may or may not show up, depending on different configuration.*

▶ **CPU Configuration**

Press [Enter] to view current CPU configuration and make settings for the following sub-items:

Hyper-Threading

The optional settings: [Disabled]; [Enabled].

When set as [Disabled] only one thread per enabled core is enabled.

[Enabled]: for Windows XP and Linux (OS optimized for Hyper-Threading Technology).

[Disabled]: for other OS (OS optimized not for Hyper-Threading Technology).

**Note: 'Hyper-Threading' item may or may not show up, depending on different CPU.*

Intel Virtualization Technology

The optional settings: [Enabled]; [Disabled].

When set as [Enabled], a VMM can utilize the additional hardware capabilities provided by Vanderpool Technology.

Hardware Prefetcher

Use this item to turn on/off the MLC streamer prefetcher.

The optional settings: [Disabled]; [Enabled].

Adjacent Cache Line Prefetch

Use this item to turn on/off prefetching of adjacent cache lines.

The optional settings: [Disabled]; [Enabled].

Intel(R) SpeedStep(tm)

This item allows more than two frequency ranges to be supported.

The optional settings: [Disabled]; [Enabled].

CPU C Status

Use this item to enable or disable CPU C status.

The optional settings: [Disabled]; [Enabled].

Package C State Limit

The optional settings are: [C0/C1]; [C2]; [C3]; [C6]; [C7]; [C7s]; [C8]; [AUTO].

▶ **Intel RMT Configuration**

Press [Enter] to go to next screen to enable or disable 'Intel Ready Mode Technology'.

Intel Ready Mode Technology

The optional settings: [Disabled]; [Enabled].

**When set as [Enabled], user can also make further settings in the following items that appear:*

Intel RMT State

Use this item to enable or disable Intel RMT enabling status in BIOS.

▶ **SATA Configuration**

Press [Enter] to make settings for the following sub-items:

SATA Controller(s)

The optional settings: [Disabled]; [Enabled].

SATA Mode Selection

The default setting is: [AHCI].

SATA1/ SATA2

Port

The optional settings: [Disabled]; [Enabled].

Use this item to enable or disable each SATA port.

Hot Plug

The optional settings: [Disabled]; [Enabled].

mSATA/M.2

Port

The optional settings: [Disabled]; [Enabled].

Use this item to enable or disable device connected to MSATA or M.2 SATA slot.

▶ **Network Stack Configuration**

Press [Enter] to go to 'Network Stack' screen to make further settings.

Network Stack

Use this item to enable or disable UEFI Network Stack.

The optional settings: [Disabled]; [Enabled].

When set as [Enabled], the following sub-items shall appear:

Ipv4 PXE Support

The optional settings are: [Disabled]; [Enabled].

Use this item to enable Ipv4 PXE Boot Support. When set as [Disabled], Ipv4 boot option will not be created.

Ipv6 PXE Support

The optional settings are: [Disabled]; [Enabled].

Use this item to enable Ipv6 PXE Boot Support. When set as [Disabled], Ipv6 boot optional will not be created.

PXE boot wait time

Use this item to set wait time to press [ESC] key to abort the PXE boot.

Media Detect Count

Use this item to set number of times presence of media will be checked.

▶ **CSM Configuration**

Press [Enter] to make settings for the following sub-items:

Option ROM execution

Network

This option controls the execution of UEFI and Legacy PXE OpROM.

The optional settings are: [Do not launch]; [UEFI]; [Legacy].

Storage

This option controls the execution of UEFI and Legacy Storage OpROM.

The optional settings are: [Do not launch]; [UEFI]; [Legacy].

Other PCI devices

This item is for PCI devices other than Network, Mass storage or video defines which OpROM to launch.

The optional settings are: [Do not launch]; [UEFI]; [Legacy].

▶ **NVMe Configuration**

Press [Enter] to check NVMe controller and driver information.

▶ **USB Configuration**

Press [Enter] to make settings for the following sub-items:

USB Configuration

Legacy USB Support

The optional settings are: [Enabled]; [Disabled]; [Auto].

[**Enabled**]: To enable legacy USB support.

[**Disabled**]: to keep USB devices available only for EFI specification,

[**Auto**]: To disable legacy support if no USB devices are connected.

XHCI Hand-off

This is a workaround for OSeS without XHCI hand-off support. The XHCI ownership change should be claimed by XHCI driver.

The optional settings are: [Enabled]; [Disabled].

USB Mass Storage Driver Support

The optional settings are: [Disabled]; [Enabled].

USB hardware delay and time-out

USB Transfer time-out

Use this item to set the time-out value for control, bulk, and interrupt transfers.

The optional settings are: [1 sec]; [5 sec]; [10 sec]; [20 sec].

Device reset time-out

Use this item to set USB mass storage device start unit command time-out.

The optional settings are: [10 sec]; [20 sec]; [30 sec]; [40 sec].

Device power-up delay

Use this item to set maximum time the device will take before it properly reports itself to the host controller. 'Auto' uses default value: for a root port it is 100 ms, for a hub port the delay is taken from hub descriptor. The optional settings: [Auto]; [Manual]. Select [Manual] you can set value for the following sub-item: '**Device Power-up delay in seconds**', the delay range in from 1 to 40 seconds, in one second increments.

▶ **Realtek PCIe GBE Family Controller(MAC:XX:XX:XX:XX:XX:XX)/ Realtek PCIe GBE Family Controller(MAC:XX:XX:XX:XX:XX:XX)**

These items show current network brief information.

3-8 Chipset Menu

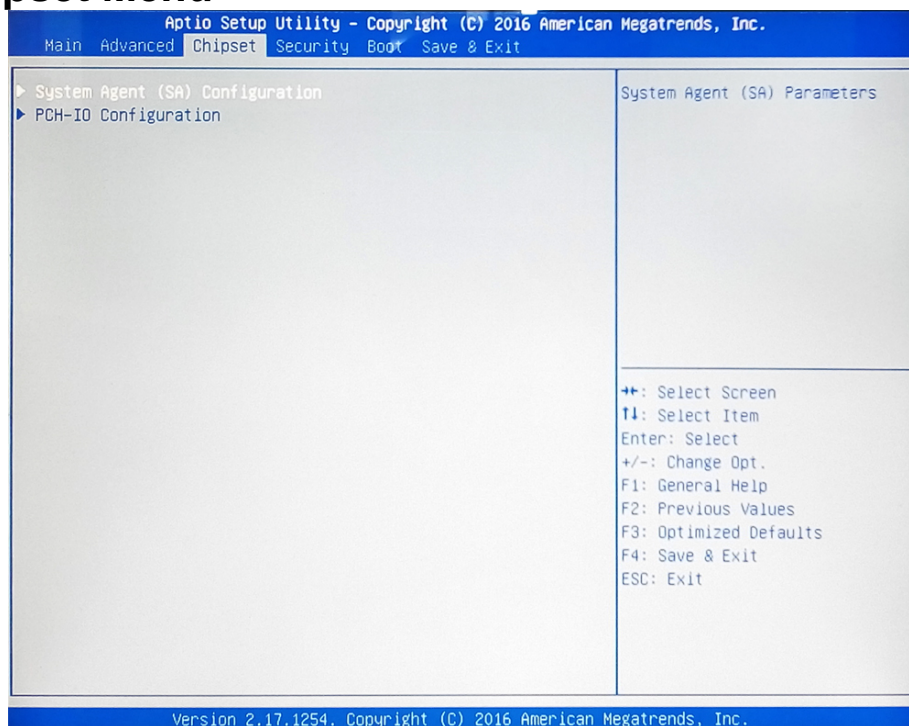

▶ **System Agent (SA) Configuration**

Press [Enter] to make settings for the following sub-items:

VT-d

The optional settings are: [Enabled]; [Disabled].

▶ **Graphics Configuration**

Press [Enter] to make further settings for Graphics Configuration.

Graphics Configuration

Primary Display

Use this item to select which of graphics device should be primary display.

The optional settings are: [Auto]; [IGFX]; [PEG].

Internal Graphics

The optional settings are: [Auto]; [Disabled]; [Enabled].

GTT Size

The optional settings are: [2MB]; [4MB]; [8MB].

Aperture Size

The optional settings are: [128MB]; [256MB]; [512MB]; [1024MB].

DVMT Pre-Allocated

Use this item to select DVMT 5.0 pre-allocated (fixed) graphics memory size used by the internal graphics device.

The optional settings are: [32M]; [64M]; [96M]; [128M]; [160M]; [192M]; [224M]; [256M]; [288M]; [320M]; [352M]; [384M]; [416M]; [448M]; [480M]; [512M]; [1024M]; [1536M]; [2048M]; [4M]; [8M]; [12M]; [16M]; [20M]; [24M]; [28M]; [32M/F7]; [36M]; [40M]; [44M]; [48M]; [52M]; [56M]; [60M].

DVMT Total Gfx Mem

Use this item to select DVMT 5.0 total graphics memory size used by the internal graphics device.

The optional settings are: [128M]; [256M]; [MAX].

Primary IGFX Boot Display

Use this item to select the video device which will be activated during POST. This has no effect if external graphics present. Secondary boot display selection will appear based on your selection.

The optional settings are: [VBIOS Default]; [HDMI]; [DP]; [eDP].

** **Note:** When set as [HDMI], [DP] or [eDP], user can make further settings in 'Second IGFX Boot Display'.*

Second IGFX Boot Display

Use this item to select second IGFX boot device..

The optional settings are: [Disabled]; [HDMI]; [DP]; [eDP].

Active eDP

The optional settings are: [Disabled]; [Enabled].

** **Note:** When set as 'Enabled', user can make further settings in 'Backlight Control'.*

Backlight Control

The optional settings are: [PWM Inverted]; [PWM Normal].

▶ **PEG Port Configuration**

Press [Enter] to make settings for the following sub-items:

PEG Port Configuration

PEG(PCIE1 Slot)

This will show current device connected to PCIE1 slot.

Max Link Speed

The optional settings are: [Auto]; [Gen1]; [Gen2]; [Gen3].

▶ **Memory Configuration**

Press [Enter] to view brief information for the working memory module.

▶ **PCH-IO Configuration**

Press [Enter] to make settings for the following sub-items:

USB Controller

The optional settings are: [Disabled]; [Enabled].

HD Audio

The optional settings are: [Disabled]; [Enabled]; [Auto].

Onboard Lan1 Controller/ Onboard Lan2 Controller

Use this item to enable or disable LAN1/LAN2 device or controller.

MPE Slot

Use this item to enable or disable the Mini-PCIE root port.

The optional settings are: [Disabled]; [Enabled].

Speed

The optional settings are: [Auto]; [Gen1]; [Gen2]; [Gen3].

System State after Power Failure

Use this item to specify what state to go to when power re-applied after a power failure (G3 state).

The optional settings are: [Always Off]; [Always On]; [Former State].

3-10 Boot Menu

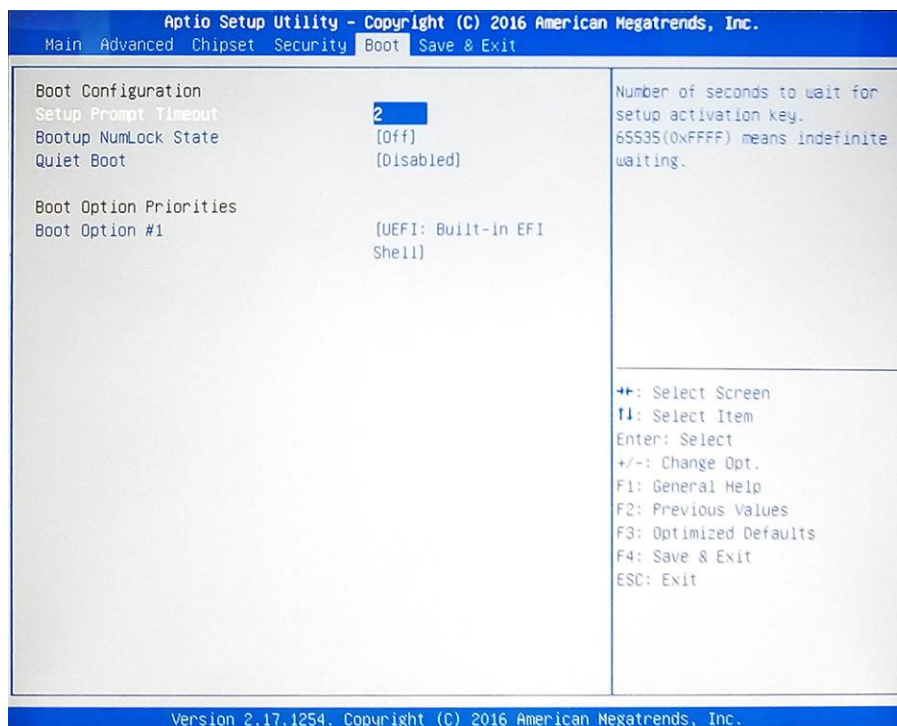

Boot Configuration

Setup Prompt Timeout

Use this item to set number of seconds to wait for setup activation key.

Bootup Numlock State

Use this item to select keyboard numlock state.

The optional settings are: [On]; [Off].

Quiet Boot

The optional settings are: [Disabled]; [Enabled].

Boot Option Priorities

Boot Option #1/ Boot Option #2...

Use this item to decide system boot order from available options.

3-11 Save & Exit Menu

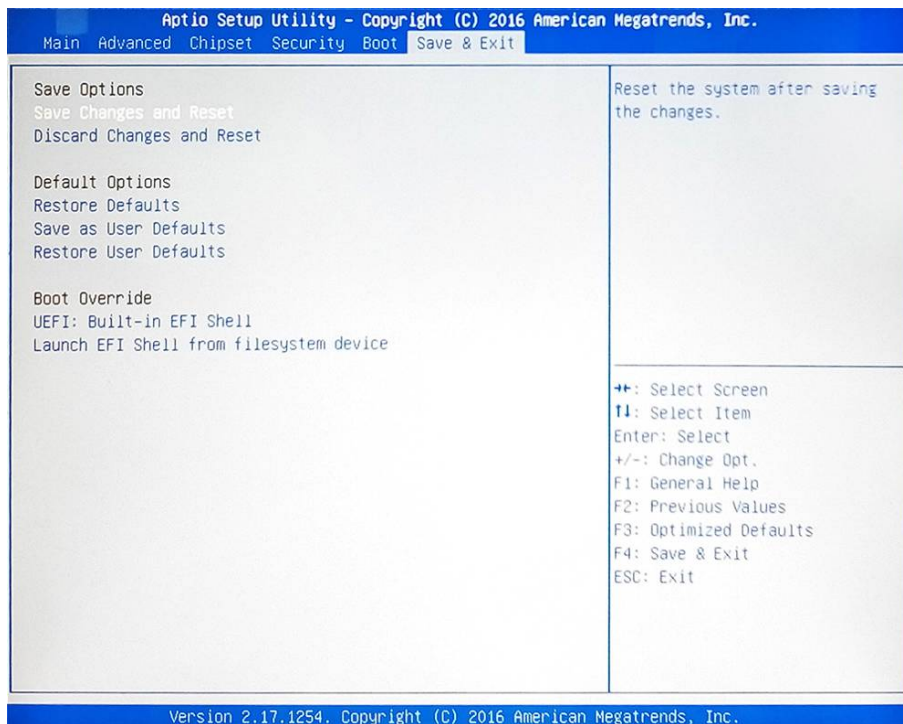

Save Options:

Save Changes and Reset

This item allows user to reset the system after saving the changes.

Discard Changes and Reset

This item allows user to reset the system without saving any changes.

Default Options:

Restore Defaults

Use this item to restore /load default values for all the setup options.

Save as User Defaults

Use this item to save the changes done so far as user defaults.

Restore User Defaults

Use this item to restore defaults to all the setup options.

Boot Override

UEFI:xx/...

Press this item to select the device as boot disk after save configuration and reset

Launch EFI Shell from filesystem device

Press this item to launch EFI Shell application (Shell.efi) from one of the available file system device.