

Unpacking

Thank you for buying the MSI® **X370 GAMING PRO** motherboard. Check to make sure your motherboard box contains the following items. If something is missing, contact your dealer as soon as possible.

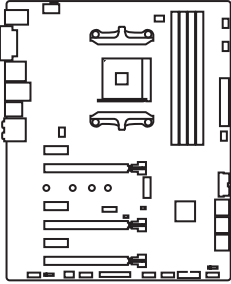

Motherboard

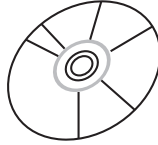

Drivers & Utilities Disc



Motherboard User Guide



I/O Shield

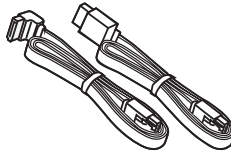

SATA Cable x2

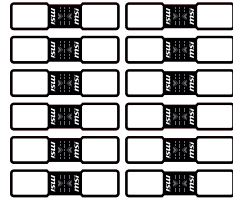

SATA Cable Labels

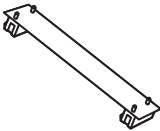

SLI Bridge Connector

Safety Information

- The components included in this package are prone to damage from electrostatic discharge (ESD). Please adhere to the following instructions to ensure successful computer assembly.
- Ensure that all components are securely connected. Loose connections may cause the computer to not recognize a component or fail to start.
- Hold the motherboard by the edges to avoid touching sensitive components.
- It is recommended to wear an electrostatic discharge (ESD) wrist strap when handling the motherboard to prevent electrostatic damage. If an ESD wrist strap is not available, discharge yourself of static electricity by touching another metal object before handling the motherboard.
- Store the motherboard in an electrostatic shielding container or on an anti-static pad whenever the motherboard is not installed.
- Before turning on the computer, ensure that there are no loose screws or metal components on the motherboard or anywhere within the computer case.
- Do not boot the computer before installation is completed. This could cause permanent damage to the components as well as injury to the user.
- If you need help during any installation step, please consult a certified computer technician.
- Always turn off the power supply and unplug the power cord from the power outlet before installing or removing any computer component.
- Keep this user guide for future reference.
- Keep this motherboard away from humidity.
- Make sure that your electrical outlet provides the same voltage as is indicated on the PSU, before connecting the PSU to the electrical outlet.
- Place the power cord such a way that people can not step on it. Do not place anything over the power cord.
- All cautions and warnings on the motherboard should be noted.
- If any of the following situations arises, get the motherboard checked by service personnel:
 - Liquid has penetrated into the computer.
 - The motherboard has been exposed to moisture.
 - The motherboard does not work well or you can not get it work according to user guide.
 - The motherboard has been dropped and damaged.
 - The motherboard has obvious sign of breakage.
- Do not leave this motherboard in an environment above 60°C (140°F), it may damage the motherboard.

Quick Start

Preparing Tools and Components

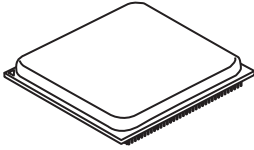

AMD® AM4 CPU

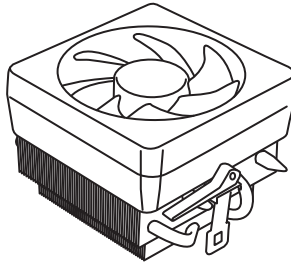

CPU Fan

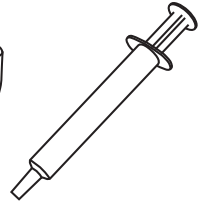

Thermal Paste

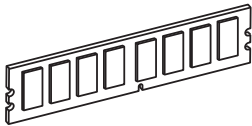

DDR4 Memory

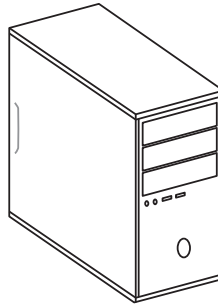

Chassis

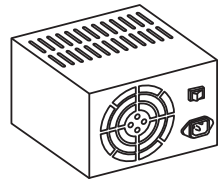

Power Supply Unit



SATA DVD Drive



SATA Hard Disk Drive

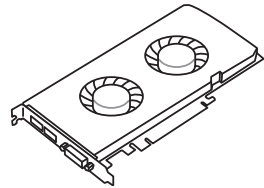

Graphics Card

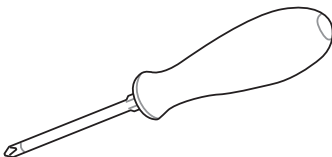

Phillips Screwdriver

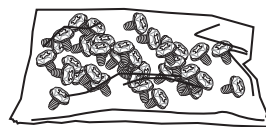

A Package of Screws

Installing a Processor



<https://youtu.be/Xv89nhFk1vc>

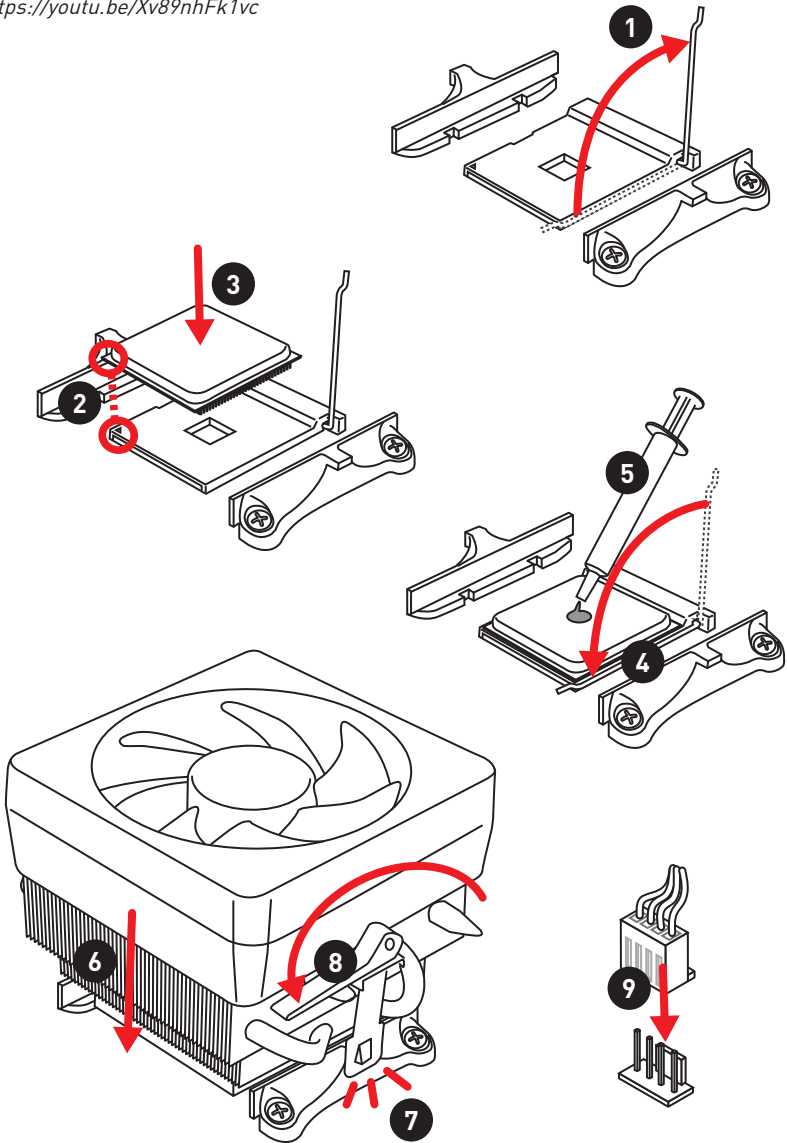

Installing DDR4 memory



<http://youtu.be/T03aDrJPYQs>

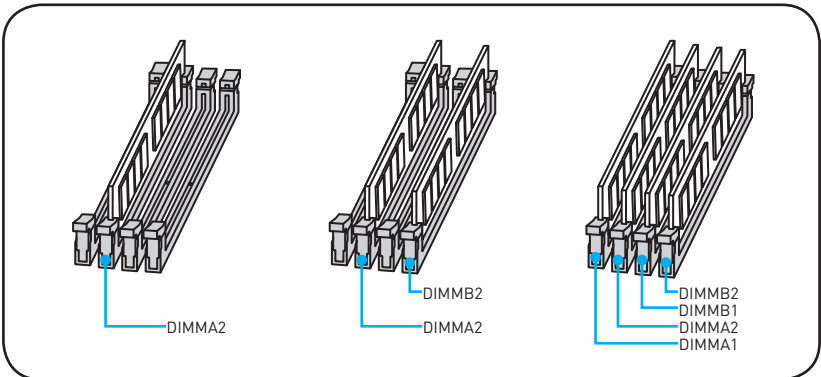
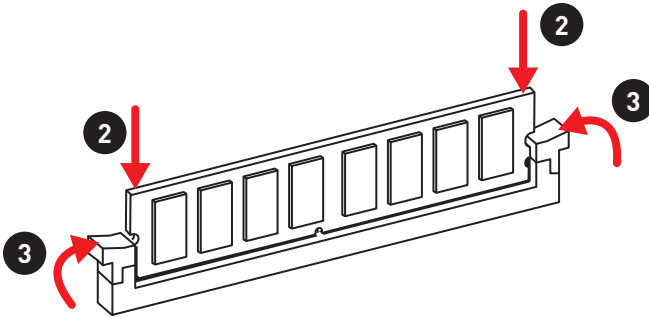
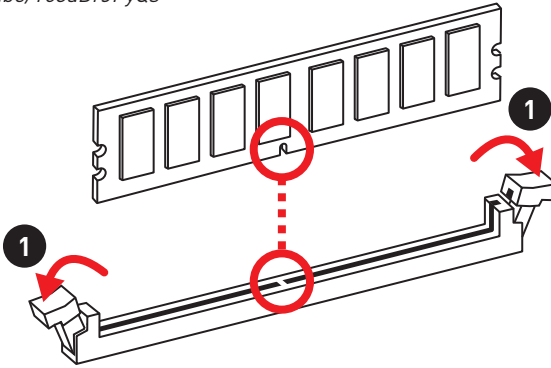

Connecting the Front Panel Header



<http://youtu.be/DPELIdVNZUI>

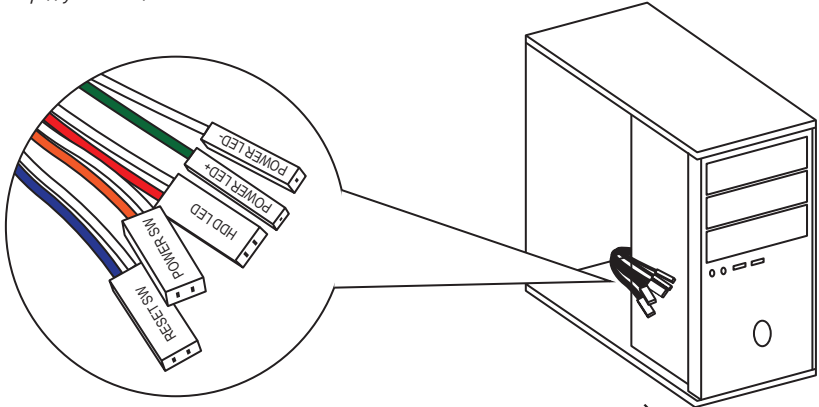

<p>JFP1</p>		1	HDD LED +	2	Power LED +
		3	HDD LED -	4	Power LED -
		5	Reset Switch	6	Power Switch
		7	Reset Switch	8	Power Switch
		9	Reserved	10	No Pin

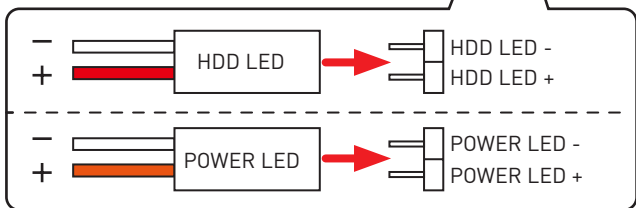
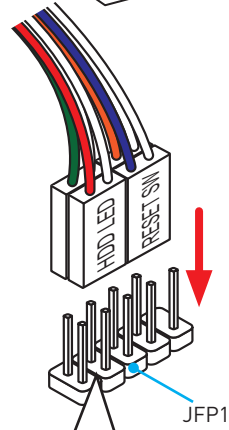

Installing the Motherboard

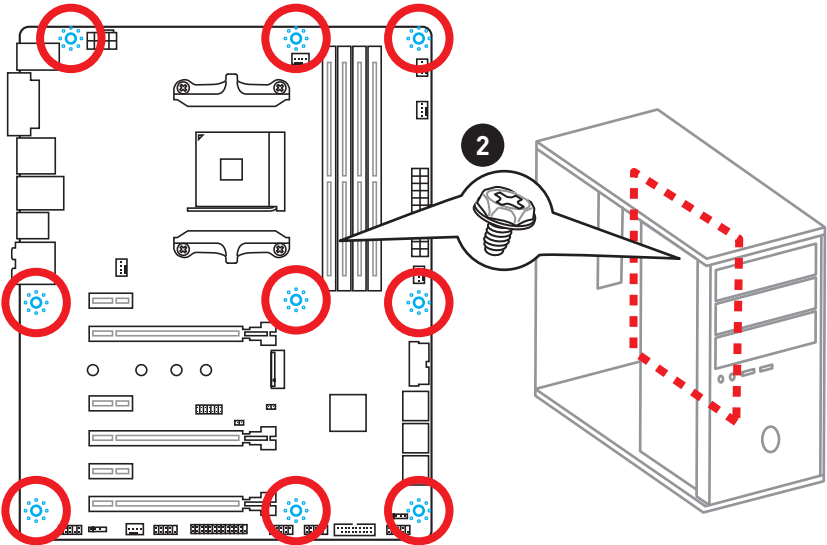
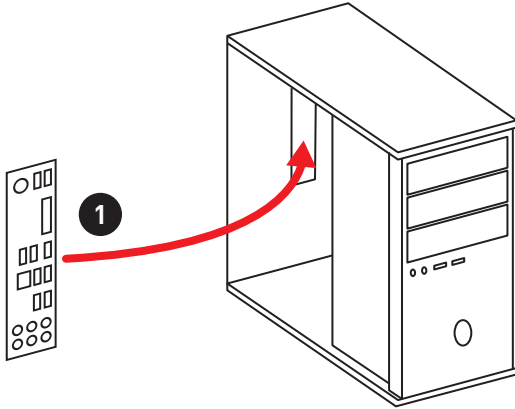

Installing SATA Drives



<http://youtu.be/RZsMpqxythc>

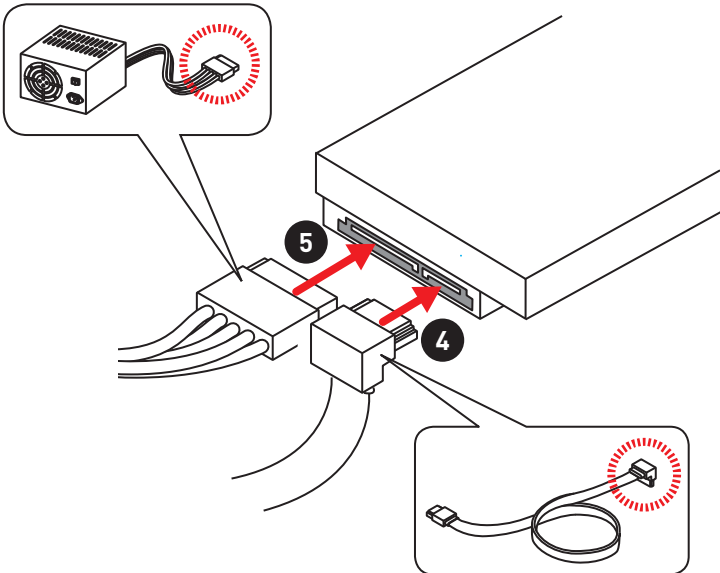
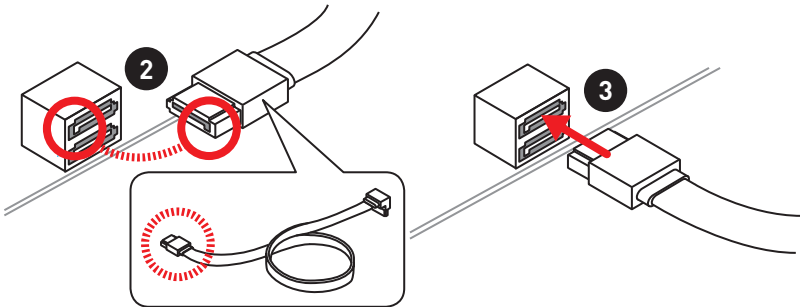
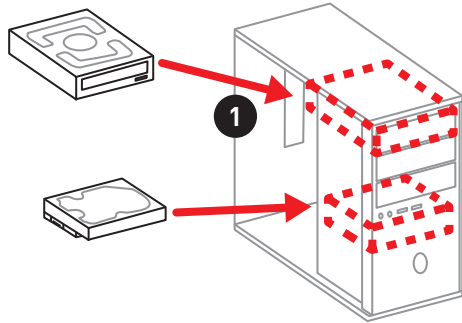

Installing a Graphics Card



http://youtu.be/mG0GZpr9w_A

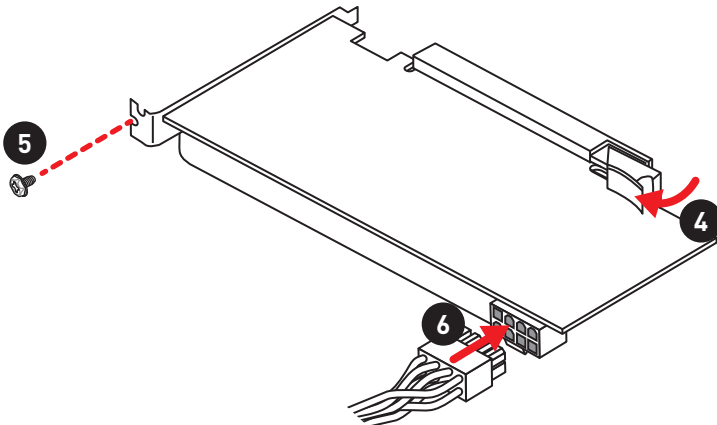
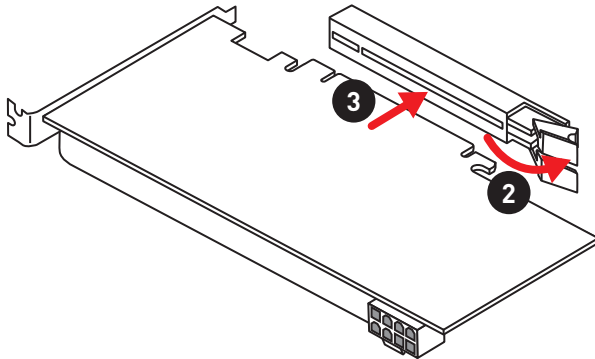
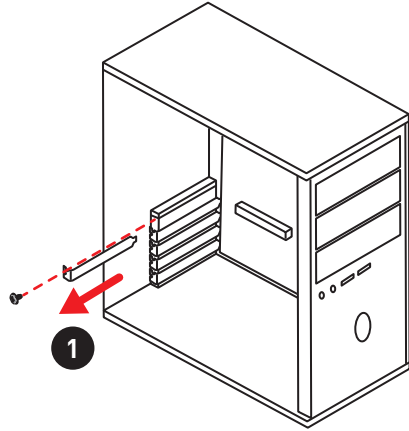

Connecting Peripheral Devices

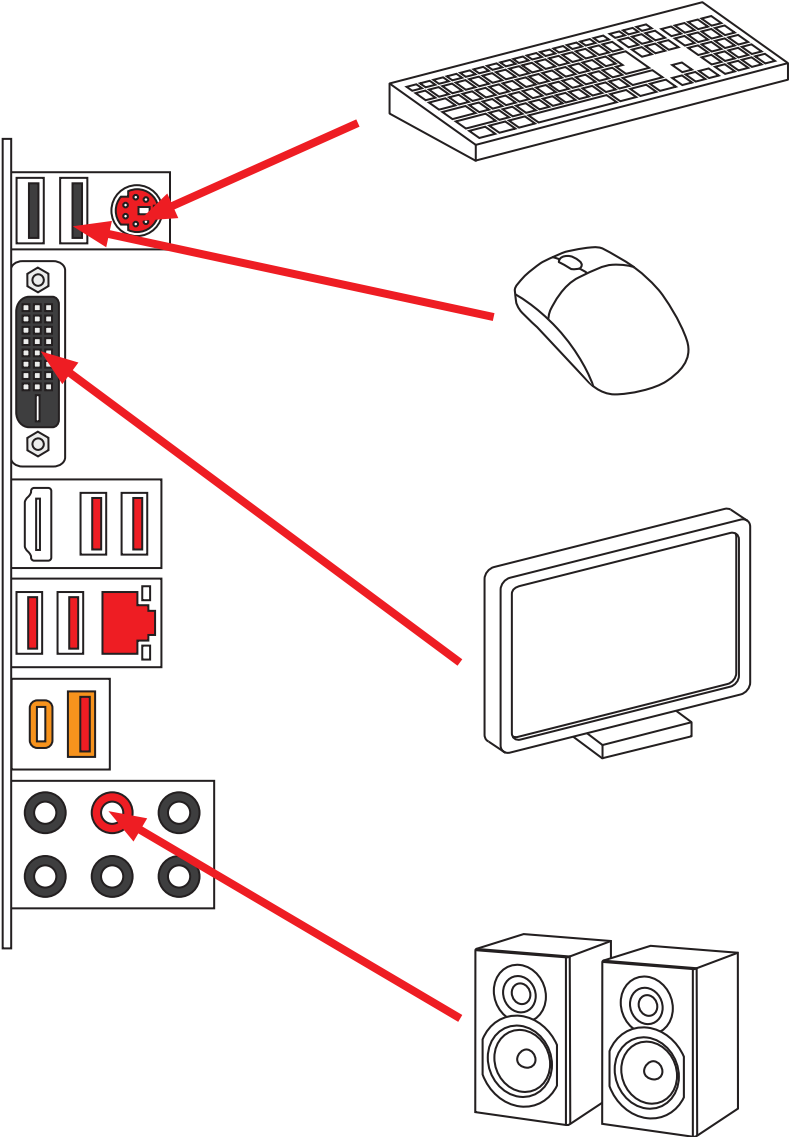

Connecting the Power Connectors



http://youtu.be/gkDYyR_8314

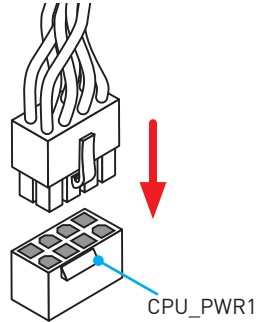
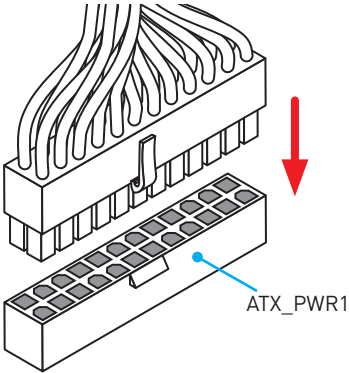
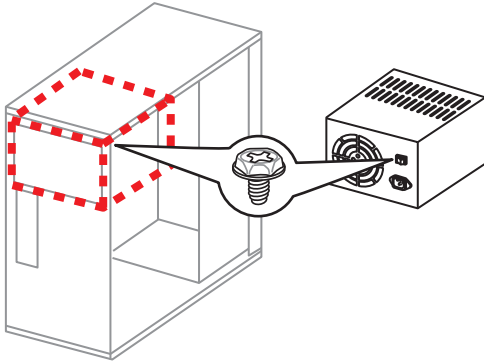

Power On

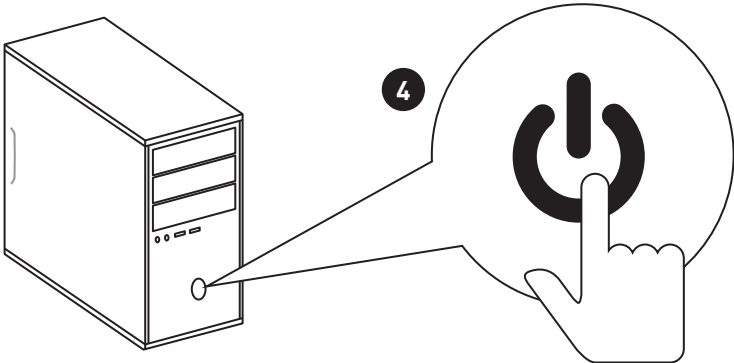
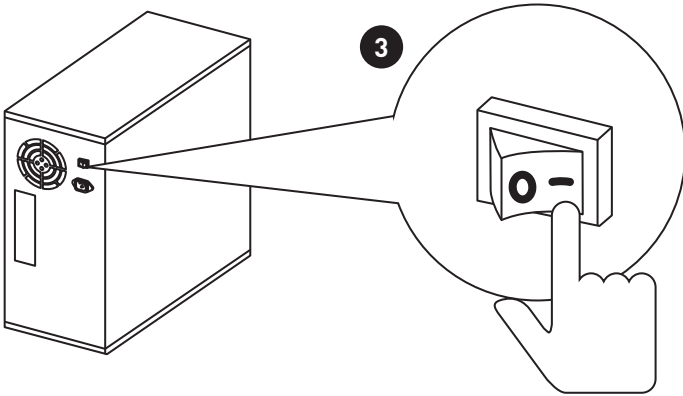
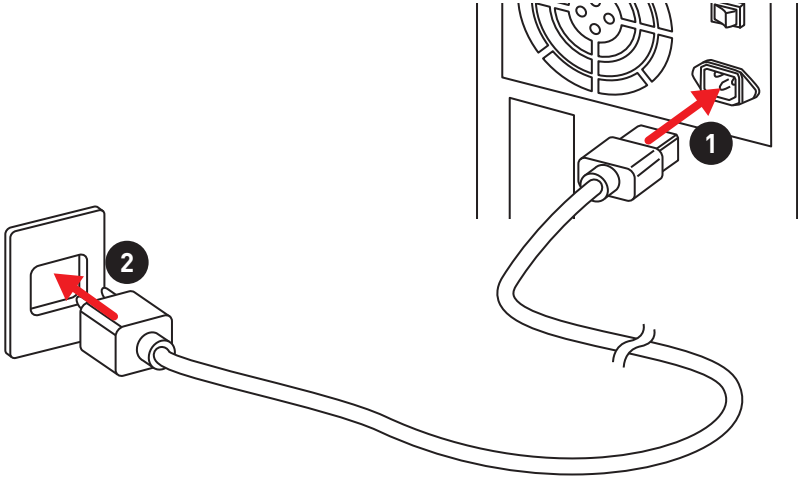

Contents

Unpacking	1
Safety Information	2
Quick Start	3
Preparing Tools and Components	3
Installing a Processor	4
Installing DDR4 memory	5
Connecting the Front Panel Header	6
Installing the Motherboard	7
Installing SATA Drives	8
Installing a Graphics Card	9
Connecting Peripheral Devices	10
Connecting the Power Connectors	11
Power On	12
Specifications	15
Block Diagram	20
Rear I/O Panel	21
LAN Port LED Status Table	21
Audio Ports Configuration	21
Realtek HD Audio Manager	22
Overview of Components	24
CPU Socket	26
DIMM Slots	27
PCI_E1~6: PCIe Expansion Slots	28
M2_1: M.2 Slot (Key M)	31
SATA1~6: SATA 6Gb/s Connectors	32
CPU_PWR1, ATX_PWR1: Power Connectors	33
JUSB1~2: USB 2.0 Connectors	34
JUSB3~4: USB 3.1 Gen1 Connectors	34
CPU_FAN1, PUMP_FAN1, SYS_FAN1~4: Fan Connectors	35
JAUD1: Front Audio Connector	36
JC11: Chassis Intrusion Connector	36
JFP1, JFP2: Front Panel Connectors	37
JTPM1: TPM Module Connector	37
JBAT1: Clear CMOS (Reset BIOS) Jumper	38
JLPT1: Parallel Port Connector	38
JCOM1: Serial Port Connector	39

JLED1: RGB LED connector	39
Onboard LEDs	40
EZ Debug LED	40
DIMM LEDs	40
GPU LED	40
PCIe x16 slot LEDs	40
BIOS Setup	41
Entering BIOS Setup	41
Resetting BIOS	42
Updating BIOS	42
Advanced Mode	45
SETTINGS	46
Advanced	46
Boot	51
Security	52
Save & Exit	53
OC	55
M-FLASH	58
OC PROFILE	59
HARDWARE MONITOR	60
Software Description	61
Installing Windows® 7 64-bit/ Windows®10 64-bit	61
Installing Drivers	61
Installing Utilities	61
LIVE UPDATE 6	62
COMMAND CENTER	64
GAMING APP	68
RAMDISK	73
X-BOOST	74
MSI SMART TOOL	76
GAMING LAN MANAGER	78
DRAGON EYE	80
XSplit Gamecaster V2	81
SteelSeries Engine 3	85
CPU-Z	87
Troubleshooting	88
Regulatory Notices	89

Specifications

CPU	Supports AMD® RYZEN series processors and 7th Gen A-series/ Athlon™ processors for Socket AM4
Chipset	AMD® X370 Chipset
Memory	<ul style="list-style-type: none"> • 4x DDR4 memory slots, support up to 64GB <ul style="list-style-type: none"> ▪ Supports DDR4 1866/ 2133/ 2400/ 2667(OC)/ 2933(OC)/ 3200(OC)+ Mhz * • Dual channel memory architecture • Supports non-ECC UDIMM memory • Supports ECC UDIMM memory (non-ECC mode) <p>* 7th Gen A-series/ Athlon™ processors support a maximum of 2400 MHz. Please refer www.msi.com for more information on compatible memory</p>
Expansion Slots	<ul style="list-style-type: none"> • 2x PCIe 3.0 x16 slots (PCI_E_2, PCI_E_4) <ul style="list-style-type: none"> ▪ RYZEN series processors support x16/x0, x8/x8 mode ▪ 7th Gen A-series/ Athlon™ processors support x8/x0 mode • 1x PCIe 2.0 x16 slot (PCI_E_6, supports x4 mode)* • 3x PCIe 2.0 x1 slots <p>* PCI_E6 slot will be PCIe 2.0 x1 when installing device in any PCIe x1 slot.</p>
Onboard Graphics	<ul style="list-style-type: none"> • 1x DVI-D port, supporting a maximum resolution of 1920x1200@60Hz, 1600x1200@60Hz* • 1x HDMI™ 1.4 port, supports a maximum resolution of 2560x1600@60Hz* <p>* Only support when using a 7th Gen A-series/ Athlon™ processors</p>
Multi-GPU	<ul style="list-style-type: none"> • RYZEN series processor <ul style="list-style-type: none"> ▪ Supports 2-Way NVIDIA® SLI™ Technology ▪ Supports 3-Way AMD® CrossFire™ Technology • 7th Gen A-series/ Athlon™ processor <ul style="list-style-type: none"> ▪ Supports 2-Way AMD® CrossFire™ Technology
Storage	<p>AMD® X370 Chipset</p> <ul style="list-style-type: none"> • 6x SATA 6Gb/s ports • 1x M.2 port (Key M) <ul style="list-style-type: none"> ▪ Supports PCIe 3.0 x4 (RYZEN series processor) or PCIe 3.0 x2 (7th Gen A-series/ Athlon™ processors) and SATA 6Gb/s 2242/ 2260 /2280/ 22110 storage devices • Supports RAID 0, RAID 1 and RAID 10

Continued on next page

Continued from previous page

USB	<ul style="list-style-type: none">• ASMedia® ASM2142 Chipset<ul style="list-style-type: none">▪ 1x USB 3.1 Gen2 (SuperSpeed USB 10Gbps) Type-C port on the back panel▪ 1x USB 3.1 Gen2 (SuperSpeed USB 10Gbps) Type-A port on the back panel• AMD® X370 Chipset<ul style="list-style-type: none">▪ 4x USB 3.1 Gen1 (SuperSpeed USB) ports available through the internal USB connectors▪ 6x USB 2.0 (High-speed USB) ports (2 Type-A ports on the back panel, 4 ports available through the internal USB connectors)• AMD® CPU<ul style="list-style-type: none">▪ 4x USB 3.1 Gen1 (SuperSpeed USB) Type-A ports on the back panel
Audio	<ul style="list-style-type: none">• Realtek® ALC892 Codec• 7.1-Channel High Definition Audio
LAN	<ul style="list-style-type: none">• 1x Realtek® 8111H Gigabit LAN controller
Back Panel Connectors	<ul style="list-style-type: none">• 1x PS/2 keyboard/ mouse combo port• 2x USB 2.0 Type-A ports• 1x DVI-D port• 1x HDMI™ 1.4 port• 1x LAN (RJ45) port• 4x USB 3.1 Gen1 Type-A ports• 1x USB 3.1 Gen2 Type-A port• 1x USB 3.1 Gen2 Type-C port• 6x audio jacks

Continued on next page

Continued from previous page

Internal Connectors	<ul style="list-style-type: none">• 1x 24-pin ATX 12V power connector• 1x 8-pin ATX 12V power connector• 6x SATA 6Gb/s connectors• 2x USB 2.0 connectors (support additional 4 USB 2.0 ports)• 2x USB 3.1 Gen1 connectors (support additional 4 USB 3.1 Gen1 ports)• 1x 4-pin CPU fan connector• 1x 4-pin PUMP fan connector (supports up to 2A)• 4x 4-pin system fan connectors• 1x RGB LED connector• 1x TPM module connector• 1x Serial port connector• 1x Parallel port connector• 1x Front panel audio connector• 2x System panel connectors• 1x Chassis Intrusion connector• 1x Clear CMOS jumper
I/O Controller	NUVOTON NCT6795D Controller Chip
Hardware Monitor	<ul style="list-style-type: none">• CPU/System temperature detection• CPU/System fan speed detection• CPU/System fan speed control
Form Factor	<ul style="list-style-type: none">• ATX Form Factor• 12 in. x 9.6 in. (30.4 cm x 24.3 cm)
BIOS Features	<ul style="list-style-type: none">• 1x 128 Mb flash• UEFI AMI BIOS• ACPI 5.0, PnP 1.0a, SM BIOS 2.8• Multi-language

Continued on next page

Continued from previous page

Software	<ul style="list-style-type: none">• Drivers• COMMAND CENTER• LIVE UPDATE 6• SUPER CHARGER• GAMING APP• RAMDISK• X-BOOST• MSI SMART TOOL• GAMING LAN MANAGER• DRAGON EYE• XSplit Gamecaster V2• Norton™ Internet Security Solution• Google Chrome™, Google Toolbar, Google Drive• SteelSeries Engine 3• CPU-Z MSI GAMING
----------	---

Continued on next page

Continued from previous page

Special Features	<ul style="list-style-type: none">• VR Boost• Audio Boost• GAMING LAN with Gaming LAN Manager• Turbo M.2• Pump Fan• Smart Fan Control• Gaming DNA with bottom LED• Mystic light SYNC• EZ debug LED• PCI-E Steel Armor• M.2 Steel Armor• Golden Plated USB with type A+C• Multi GPU – SLI Technology• Multi GPU – CrossFire Technology• DDR4 Boost• GAME Boost• Lightning USB• Military Class 4• 7000+ Quality Test• GAMING HOTKEY• GAMING MOUSE Control• Click BIOS 5• AMD FreeSync™ Ready• AMD OverDrive™ Ready• GAMING Certified• SteelSeries Certified• WTFast GPN*<ul style="list-style-type: none">▪ 2-Month Premium License▪ Multi-Server Network Optimization▪ Advanced Lag Spike & Disconnect Reduction <p>* This offer is valid for a limited period only, for more information please visit www.msi.com</p>
------------------	--

Block Diagram

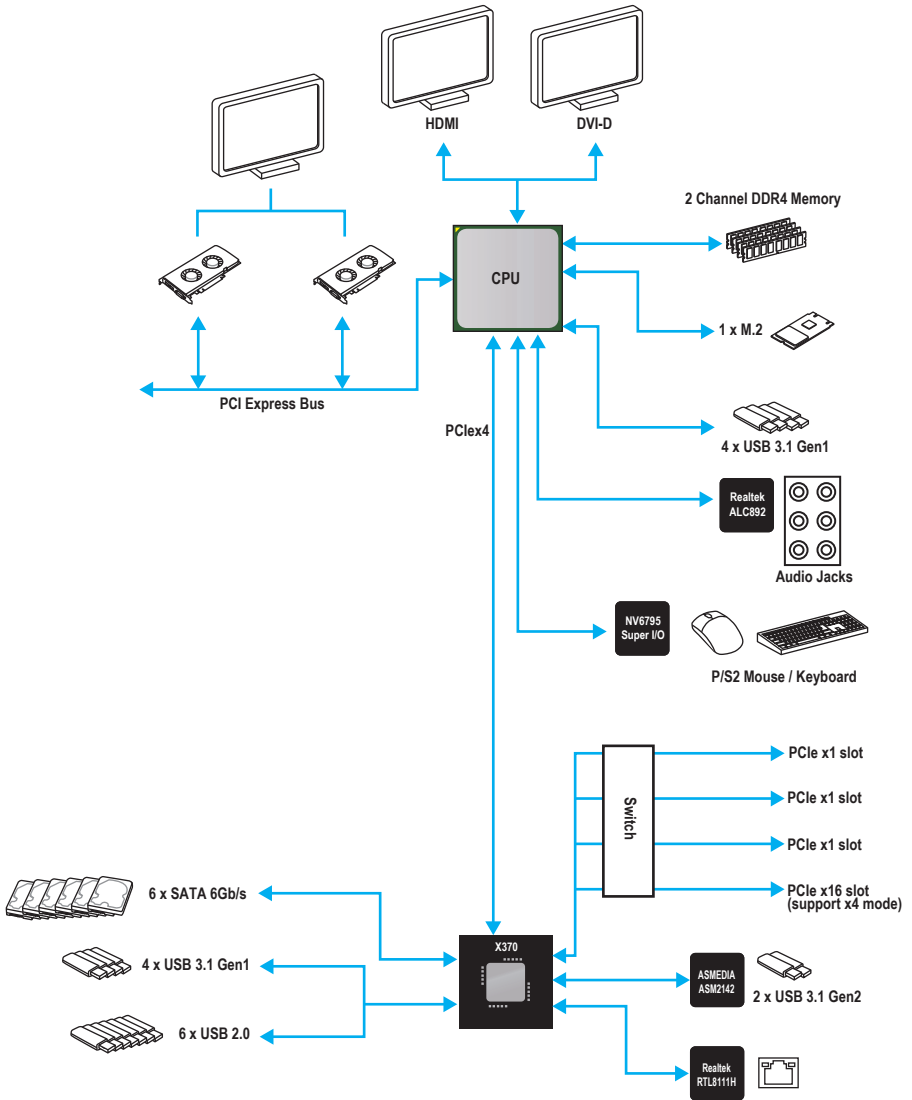

Rear I/O Panel

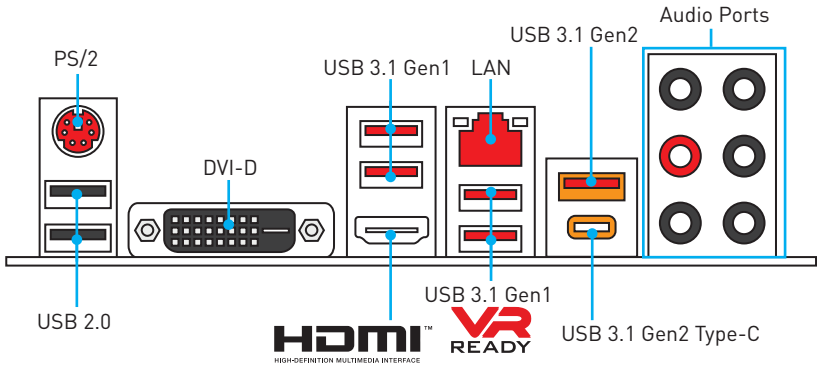

LAN Port LED Status Table

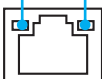
Link/ Activity LED			Speed LED	
Status	Description		Status	Description
Off	No link		Off	10 Mbps connection
Yellow	Linked		Green	100 Mbps connection
Blinking	Data activity		Orange	1 Gbps connection

Audio Ports Configuration

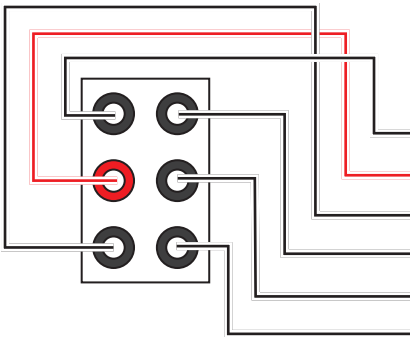

Audio Ports	Channel			
	2	4	6	8
Line-In				
Line-Out/ Front Speaker Out	●	●	●	●
Mic In				
Rear Speaker Out		●	●	●
Center/ Subwoofer Out			●	●
Side Speaker Out				●

(●: connected, **Blank**: empty)

Realtek HD Audio Manager

After installing the **Realtek HD Audio** driver, the **Realtek HD Audio Manager** icon will appear in the system tray. Double click on the icon to launch.



- **Device Selection** - allows you to select a audio output source to change the related options. The **check** sign indicates the devices as default.
- **Application Enhancement** - the array of options will provide you a complete guidance of anticipated sound effect for both output and input device.
- **Main Volume** - controls the volume or balance the right/left side of the speakers that you plugged in front or rear panel by adjust the bar.
- **Profiles** - toggles between profiles.
- **Advanced Settings** - provides the mechanism to deal with 2 independent audio streams.
- **Jack Status** - depicts all render and capture devices currently connected with your computer.
- **Connector Settings** - configures the connection settings.

Auto popup dialog

When you plug into a device at an audio jack, a dialogue window will pop up asking you which device is current connected.

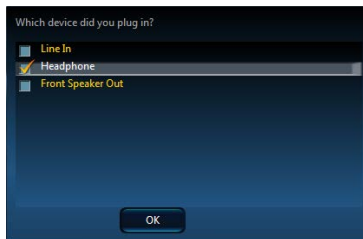

Each jack corresponds to its default setting as shown on the next page.

Audio jacks to headphone and microphone diagram

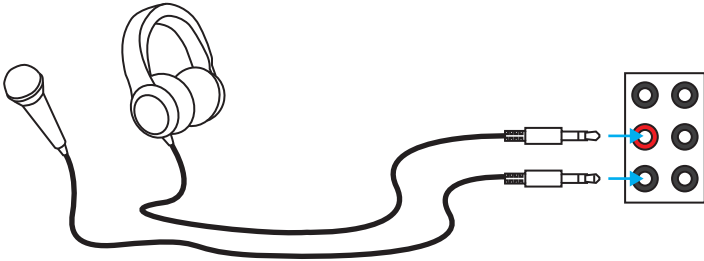

Audio jacks to stereo speakers diagram

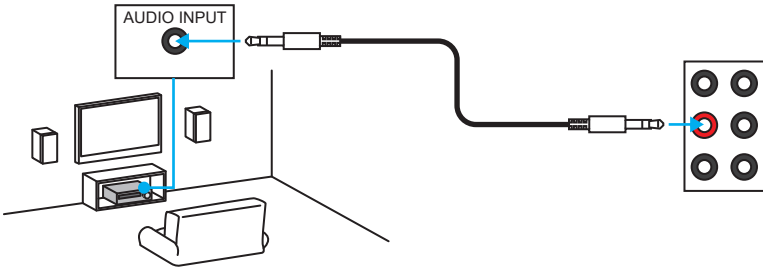

Audio jacks to 7.1-channel speakers diagram

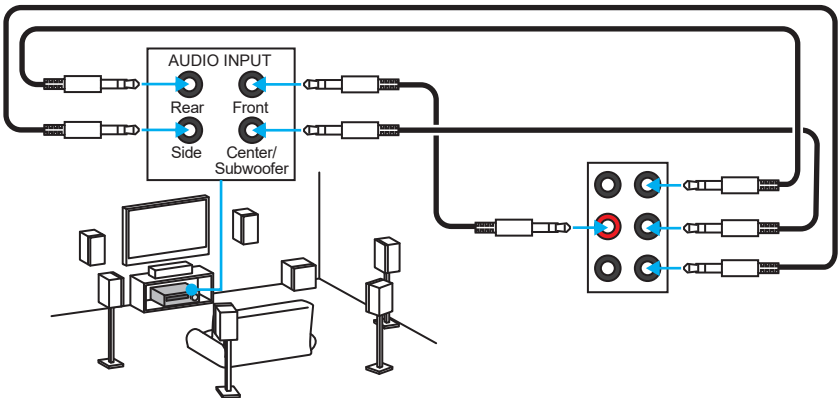

Overview of Components

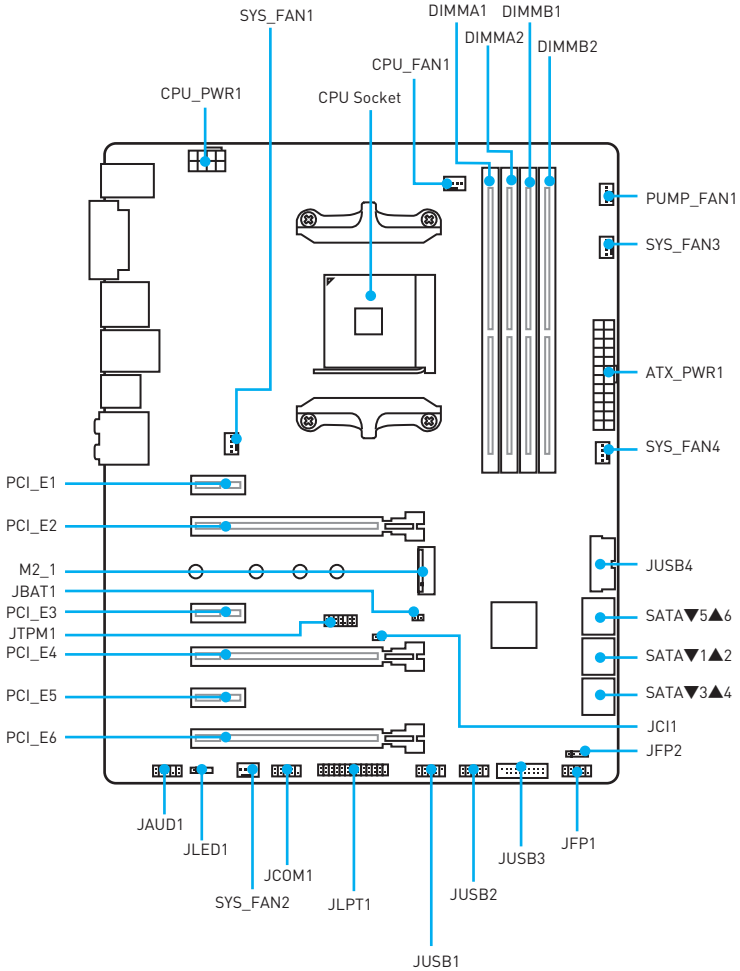

Component Contents

Port Name	Port Type	Page
CPU_FAN1, PUMP_FAN1, SYS_FAN1~4	Fan Connectors	35
CPU_PWR1, ATX_PWR1	Power Connectors	33
CPU Socket	AM4 CPU Socket	26
DIMMA1, DIMMA2, DIMMB1, DIMMB2	DIMM Slots	27
JAUD1	Front Audio Connector	36
JBAT1	Clear CMOS (Reset BIOS) Jumper	38
JCI1	Chassis Intrusion Connector	36
JCOM1	Serial Port Connector	39
JFP1, JFP2	Front Panel Connectors	37
JLED1	RGB LED connector	39
JLPT1	Parallel Port Connector	38
JTPM1	TPM Module Connector	37
JUSB1~2	USB 2.0 Connectors	34
JUSB3~4	USB 3.1 Gen1 Connectors	34
M2_1	M.2 Slot (Key M)	31
PCI_E1~6	PCIe Expansion Slots	28
SATA1~6	SATA 6Gb/s Connectors	32

CPU Socket

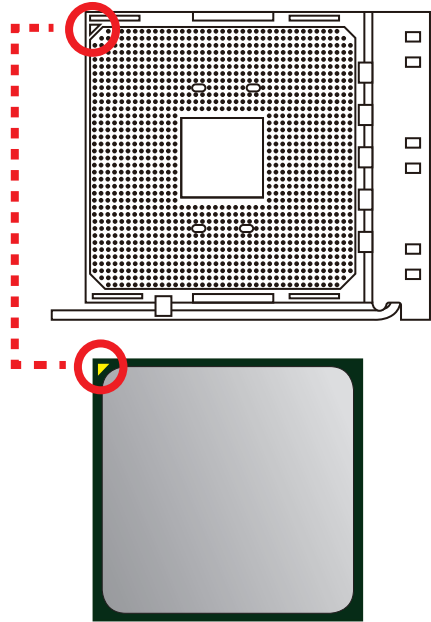
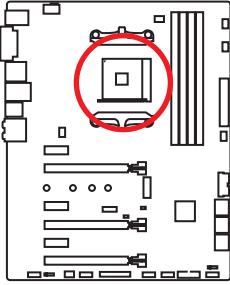

Introduction to the AM4 CPU

The surface of the AM4 CPU has a yellow triangle to assist in correctly lining up the CPU for motherboard placement. The yellow triangle is the Pin 1 indicator.

Important

- When changing the processor, the system configuration could be cleared and reset BIOS to default values, due to the AM4 processor's architecture.
- Always unplug the power cord from the power outlet before installing or removing the CPU.
- When installing a CPU, always remember to install a CPU heatsink. A CPU heatsink is necessary to prevent overheating and maintain system stability.
- Confirm that the CPU heatsink has formed a tight seal with the CPU before booting your system.
- Overheating can seriously damage the CPU and motherboard. Always make sure the cooling fans work properly to protect the CPU from overheating. Be sure to apply an even layer of thermal paste (or thermal tape) between the CPU and the heatsink to enhance heat dissipation.
- If you purchased a separate CPU and heatsink/ cooler, Please refer to the documentation in the heatsink/ cooler package for more details about installation.
- This motherboard is designed to support overclocking. Before attempting to overclock, please make sure that all other system components can tolerate overclocking. Any attempt to operate beyond product specifications is not recommended. MSI® does not guarantee the damages or risks caused by inadequate operation beyond product specifications.

DIMM Slots

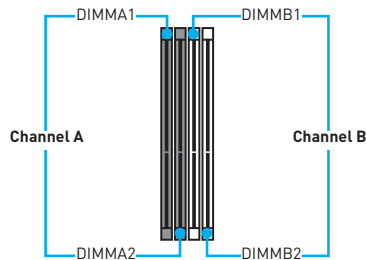
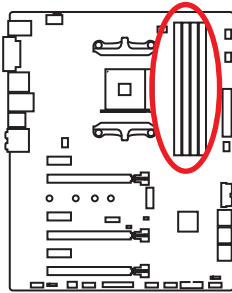

Memory module installation recommendation

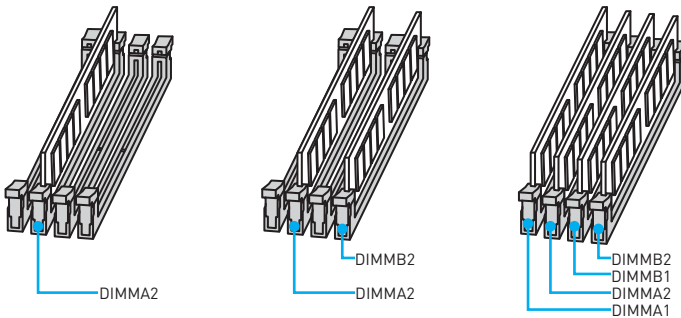

Important

- Always insert memory modules in the **DIMMA2** slot first.
- Due to chipset resource usage, the available capacity of memory will be a little less than the amount of installed.
- Based on the processor specification, the Memory DIMM voltage below 1.35V is suggested to protect the processor.
- Some memory modules may operate at a lower frequency than the marked value when overclocking due to the memory frequency operates dependent on its Serial Presence Detect (SPD). Go to BIOS and find the **DRAM Frequency** to set the memory frequency if you want to operate the memory at the marked or at a higher frequency.
- It is recommended to use a more efficient memory cooling system for full DIMMs installation or overclocking.
- The stability and compatibility of installed memory module depend on installed CPU and devices when overclocking.
- Due to AM4 CPU/memory controller official specification limitation, the frequency of memory modules may operate lower than the marked value under the default state. Please refer www.msi.com for more information on compatible memory.

PCI_E1~6: PCIe Expansion Slots

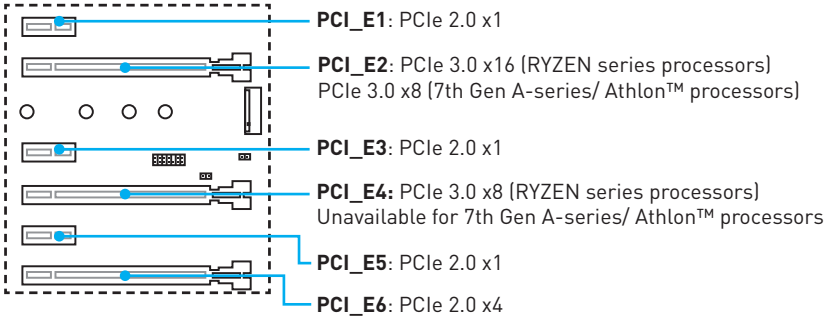

Multiple graphics cards installation recommendation (RYZEN series processors)

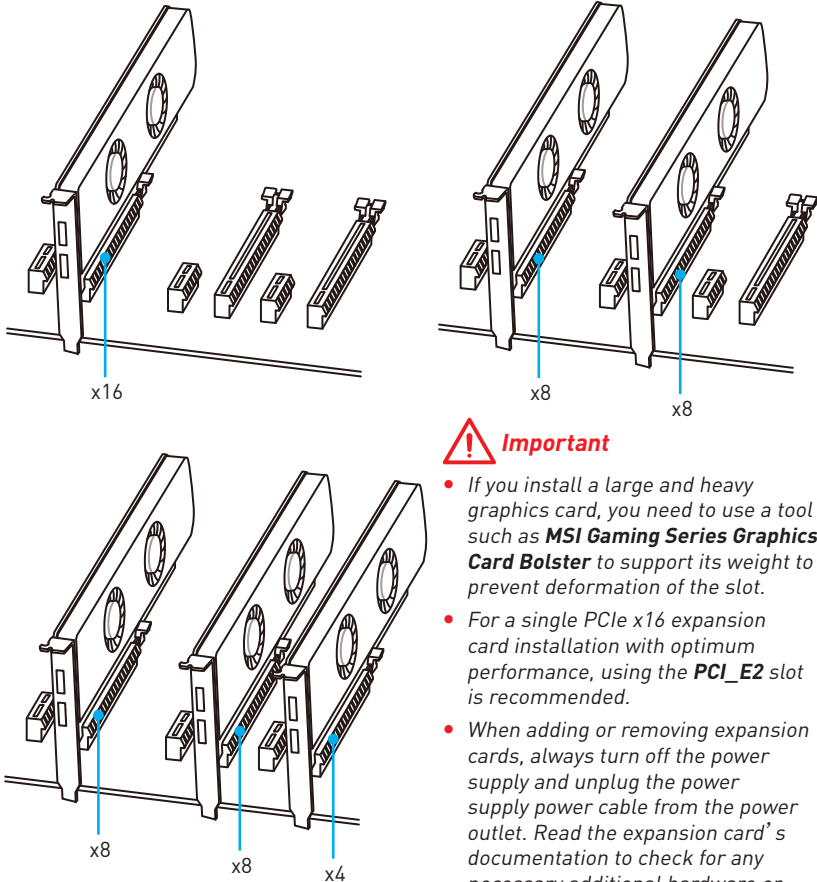

Important

- If you install a large and heavy graphics card, you need to use a tool such as **MSI Gaming Series Graphics Card Bolster** to support its weight to prevent deformation of the slot.
- For a single PCIe x16 expansion card installation with optimum performance, using the **PCI_E2** slot is recommended.
- When adding or removing expansion cards, always turn off the power supply and unplug the power supply power cable from the power outlet. Read the expansion card's documentation to check for any necessary additional hardware or software changes.

PCIe bandwidth table

For RYZEN series processors

Slot	Single		2-Way		3-Way
PCI_E1	—	Gen 2.0 x 1	—	Gen 2.0 x 1	—
PCI_E2	Gen 3.0 x 16*	Gen 3.0 x 16*	Gen 3.0 x 8*	Gen 3.0 x 8*	Gen 3.0 x 8*
PCI_E3	—	Gen 2.0 x 1	—	Gen 2.0 x 1	—
PCI_E4	—	—	Gen 3.0 x 8*	Gen 3.0 x 8*	Gen 3.0 x 8*
PCI_E5	—	Gen 2.0 x 1	—	Gen 2.0 x 1	—
PCI_E6	Gen 2.0 x 4	Gen 2.0 x 1	Gen 2.0 x 4	Gen 2.0 x 1	Gen 2.0 x 4*
M2_1	Gen 3.0 x 4	Gen 3.0 x 4	Gen 3.0 x 4	Gen 3.0 x 4	Gen 3.0 x 4

(—: empty, *: graphics card)

For 7th Gen A-series/ Athlon™ processors

Slot	Single		2-Way
PCI_E1	—	Gen 2.0 x 1	—
PCI_E2	Gen 3.0 x 8*	Gen 3.0 x 8*	Gen 3.0 x 8*
PCI_E3	—	Gen 2.0 x 1	—
PCI_E4	—	—	—
PCI_E5	—	Gen 2.0 x 1	—
PCI_E6	Gen 2.0 x 4	Gen 2.0 x 1	Gen 2.0 x 4*
M2_1	Gen 3.0 x 2	Gen 3.0 x 2	Gen 3.0 x 2

(—: empty, *: graphics card)

Installing SLI graphics cards

For power supply recommendations for SLI configurations, please refer to the user guide of your graphics card to make sure you meet all the system requirements.

To install SLI graphics cards:

1. Turn off your computer and disconnect the power cord, install two graphics cards into the **PCI_E2** and **PCI_E4** slots.
2. Connect the two cards together using the **SLI Bridge Connector**.

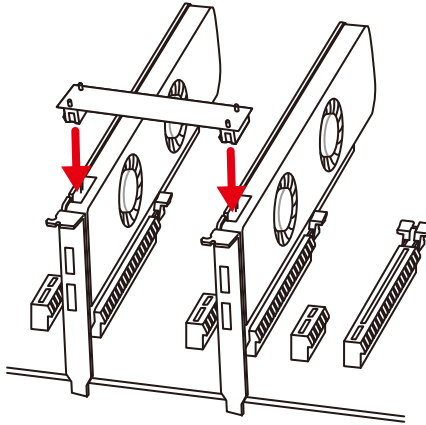

3. Connect all PCIe power connectors of the graphics cards.
4. Reconnect the power cord, power up the computer and install the drivers and software included in your graphics card package.
5. Right-click the Windows desktop and select **NVIDIA Control Panel** from the menu, click on **Configure SLI, Surround, PhysX** in the left task pane and select **Maximize 3D performance** in the SLI configuration menu, and then click **Apply**.

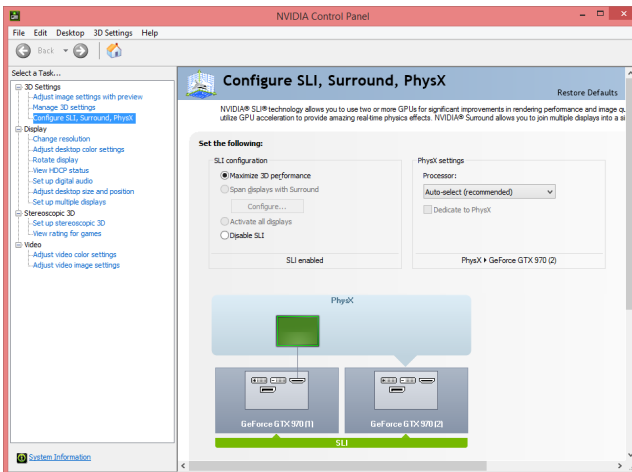

M2_1: M.2 Slot (Key M)

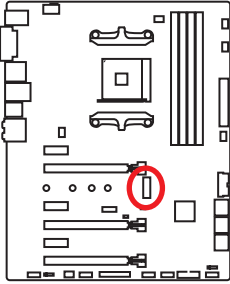

Video Demonstration

Watch the video to learn how to use M.2 Shield.

https://youtu.be/b-N28ajX_C4

Installing M.2 module

1. Remove the screw from the base screw.
2. Remove the base screw.

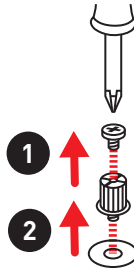

3. Tighten the base screw into the hole of the distance to the M.2 slot as the length your M.2 module.
4. Insert your M.2 module into the M.2 slot at a 30-degree angle.

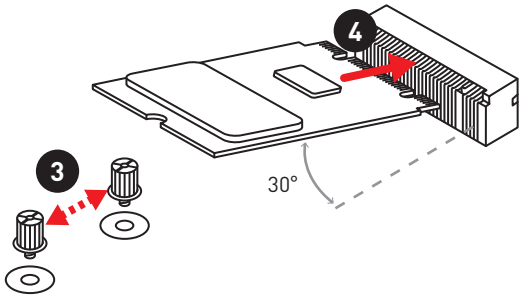

5. Put the screw in the notch on the trailing edge of your M.2 module and tighten it into the base screw.

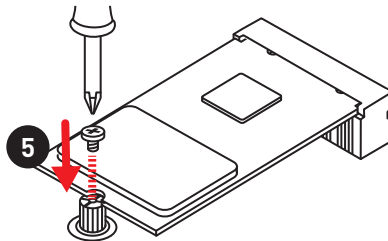

SATA1~6: SATA 6Gb/s Connectors

These connectors are SATA 6Gb/s interface ports. Each connector can connect to one SATA device.

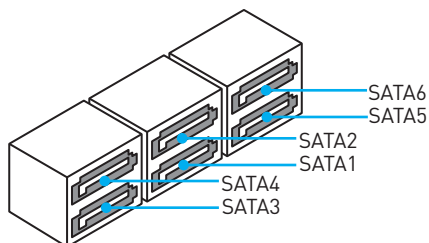
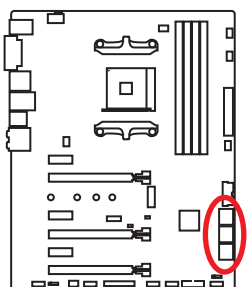



Important

- Please do not fold the SATA cable at a 90-degree angle. Data loss may result during transmission otherwise.
- SATA cables have identical plugs on either sides of the cable. However, it is recommended that the flat connector be connected to the motherboard for space saving purposes.

CPU_PWR1, ATX_PWR1: Power Connectors

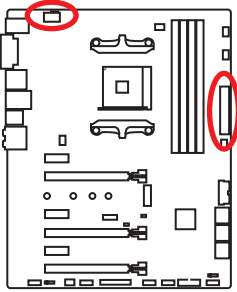
These connectors allow you to connect an ATX power supply.

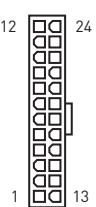

 CPU_PWR1			
1	Ground	5	+12V
2	Ground	6	+12V
3	Ground	7	+12V
4	Ground	8	+12V

 ATX_PWR1			
1	+3.3V	13	+3.3V
2	+3.3V	14	-12V
3	Ground	15	Ground
4	+5V	16	PS-ON#
5	Ground	17	Ground
6	+5V	18	Ground
7	Ground	19	Ground
8	PWR OK	20	Res
9	5VSB	21	+5V
10	+12V	22	+5V
11	+12V	23	+5V
12	+3.3V	24	Ground

Important

Make sure that all the power cables are securely connected to a proper ATX power supply to ensure stable operation of the motherboard.

JUSB1~2: USB 2.0 Connectors

These connectors allow you to connect USB 2.0 ports on the front panel.

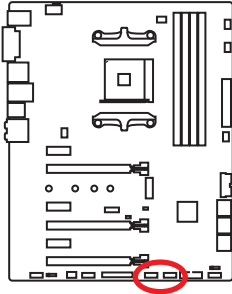

1	VCC	2	VCC
3	USB0-	4	USB1-
5	USB0+	6	USB1+
7	Ground	8	Ground
9	No Pin	10	NC

Important

- Note that the VCC and Ground pins must be connected correctly to avoid possible damage.
- In order to recharge your iPad, iPhone and iPod through USB ports, please install MSI® SUPER CHARGER utility.

JUSB3~4: USB 3.1 Gen1 Connectors

These connectors allow you to connect USB 3.1 Gen1 ports on the front panel.

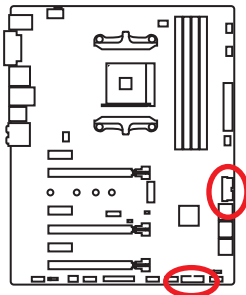

1	Power	11	USB2.0+
2	USB3_RX_DN	12	USB2.0-
3	USB3_RX_DP	13	Ground
4	Ground	14	USB3_TX_C_DP
5	USB3_TX_C_DN	15	USB3_TX_C_DN
6	USB3_TX_C_DP	16	Ground
7	Ground	17	USB3_RX_DP
8	USB2.0-	18	USB3_RX_DN
9	USB2.0+	19	Power
10	NC	20	No Pin

Important

Note that the Power and Ground pins must be connected correctly to avoid possible damage.

CPU_FAN1, PUMP_FAN1, SYS_FAN1~4: Fan Connectors

Fan connectors can be classified as PWM (Pulse Width Modulation) Mode or DC Mode. PWM Mode fan connectors provide constant 12V output and adjust fan speed with speed control signal. DC Mode fan connectors control fan speed by changing voltage. When you plug a 3-pin (Non-PWM) fan to a fan connector in PWM mode, the fan speed will always maintain at 100%, which might create a lot of noise. You can follow the instruction below to adjust the fan connector to PWM or DC Mode.

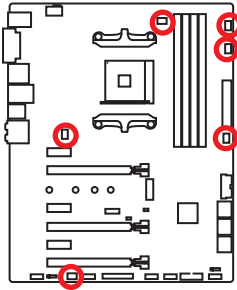

Default PWM Mode fan connectors



Default DC Mode fan connectors

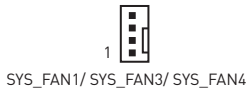

Switching fan mode and adjusting fan speed

You can switch between PWM mode and DC mode and adjust fan speed in **BIOS > HARDWARE MONITOR**.

Select **PWM** mode or **DC** mode

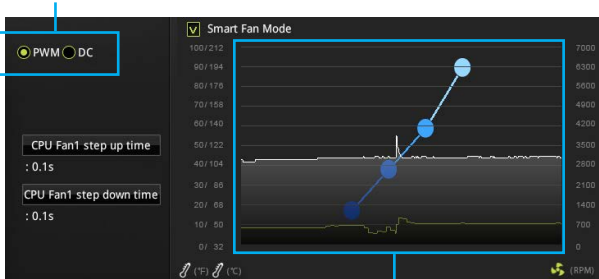

There are gradient points of the fan speed that allow you to adjust fan speed in relation to CPU temperature.



Make sure fans are working properly after switching the PWM/ DC mode.

Pin definition of fan connectors

PWM Mode pin definition			
1	Ground	2	+12V
3	Sense	4	Speed Control Signal

DC Mode pin definition			
1	Ground	2	Voltage Control
3	Sense	4	NC

JAUD1: Front Audio Connector

This connector allows you to connect audio jacks on the front panel.

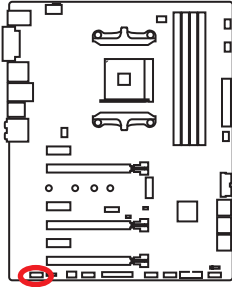

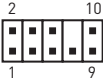
			
1	MIC L	2	Ground
3	MIC R	4	NC
5	Head Phone R	6	MIC Detection
7	SENSE_SEND	8	No Pin
9	Head Phone L	10	Head Phone Detection

JCI1: Chassis Intrusion Connector

This connector allows you to connect the chassis intrusion switch cable.

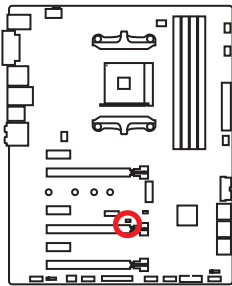

Normal
(default)



Trigger the chassis
intrusion event

Using chassis intrusion detector

1. Connect the **JCI1** connector to the chassis intrusion switch/ sensor on the chassis.
2. Close the chassis cover.
3. Go to **BIOS > Settings > Security > Chassis Intrusion Configuration**.
4. Set **Chassis Intrusion** to **Enabled**.
5. Press **F10** to save and exit and then press the **Enter** key to select **Yes**.
6. Once the chassis cover is opened again, a warning message will be displayed on screen when the computer is turned on.

Resetting the chassis intrusion warning

1. Go to **BIOS > Settings > Security > Chassis Intrusion Configuration**.
2. Set **Chassis Intrusion** to **Reset**.
3. Press **F10** to save and exit and then press the **Enter** key to select **Yes**.

JFP1, JFP2: Front Panel Connectors

These connectors connect to the switches and LEDs on the front panel.

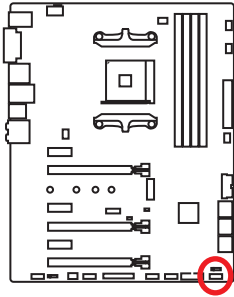

1	HDD LED +	2	Power LED +
3	HDD LED -	4	Power LED -
5	Reset Switch	6	Power Switch
7	Reset Switch	8	Power Switch
9	Reserved	10	No Pin

1	Speaker -	2	Buzzer +
3	Buzzer -	4	Speaker +

JTPM1: TPM Module Connector

This connector is for TPM (Trusted Platform Module). Please refer to the TPM security platform manual for more details and usages.

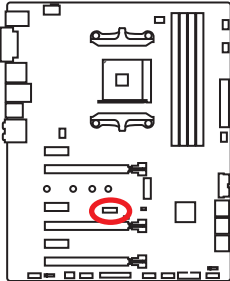

1	LPC Clock	2	3V Standby power
3	LPC Reset	4	3.3V Power
5	LPC address & data pin0	6	Serial IRQ
7	LPC address & data pin1	8	5V Power
9	LPC address & data pin2	10	No Pin
11	LPC address & data pin3	12	Ground
13	LPC Frame	14	Ground

JBAT1: Clear CMOS (Reset BIOS) Jumper

There is CMOS memory onboard that is external powered from a battery located on the motherboard to save system configuration data. If you want to clear the system configuration, set the jumpers to clear the CMOS memory.

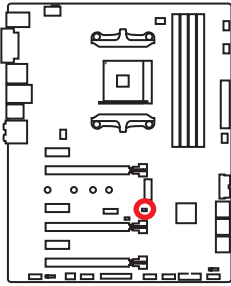

Keep Data
(default)



Clear CMOS/
Reset BIOS

Resetting BIOS to default values

1. Power off the computer but **DO NOT** unplug the power cord (system under S5/ Soft-off mode)
2. Use a jumper cap to short JBAT1 for about 5-10 seconds.
3. Remove the jumper cap from JBAT1.
4. Power on the computer.

JLPT1: Parallel Port Connector

This connector allows you to connect the optional parallel port with bracket.

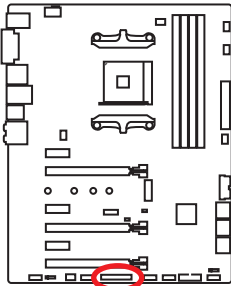

1	RSTB#	2	AFD#	3	PRND0
4	ERR#	5	PRND1	6	PINIT#
7	PRND2	8	LPT_SLIN#	9	PRND3
10	Ground	11	PRND4	12	Ground
13	PRND5	14	Ground	15	PRND6
16	Ground	17	PRND7	18	Ground
19	ACK#	20	Ground	21	BUSY
22	Ground	23	PE	24	Ground
25	SLCT	26	No Pin		

JCOM1: Serial Port Connector

This connector allows you to connect the optional serial port with bracket.

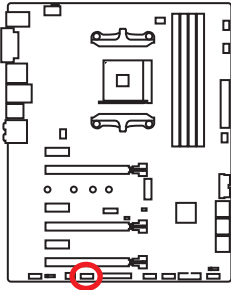

1	DCD	2	SIN
3	SOUT	4	DTR
5	Ground	6	DSR
7	RTS	8	CTS
9	RI	10	No Pin

JLED1: RGB LED connector

These connectors allow you to connect the 5050 RGB LED strips.

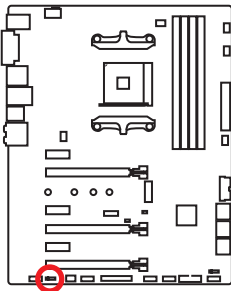

1	+12V	2	G
3	R	4	B

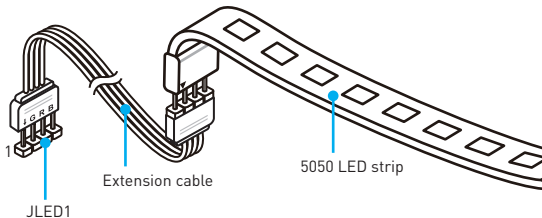

Video Demonstration

Watch the video to learn how to install 5050 RGB LED strips to RGB LED connector.

<https://youtu.be/CqNHyaDzd2Q>

Important

- This connector supports 5050 multi-color LED strips with the maximum power rating of 3A (12V). Please keeping the LED strip shorter than 2 meters to prevent dimming.
- Always turn off the power supply and unplug the power cord from the power outlet before installing or removing the LED strip.
- Please use GAMING APP to control the extended LED strip.

Onboard LEDs

EZ Debug LED

These LEDs indicate the debug status of the motherboard.

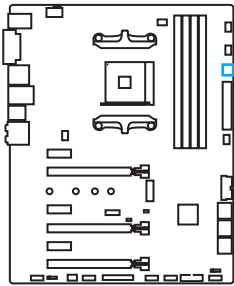

- CPU** - indicates CPU is not detected or fail.
- DRAM** - indicates DRAM is not detected or fail.
- VGA** - indicates GPU is not detected or fail.
- BOOT** - indicates the booting device is not detected or fail.

DIMM LEDs

These LEDs indicate the memory modules are installed.

GPU LED

This LED indicates the CPU's iGPU is not detected and you need to install a graphics card.

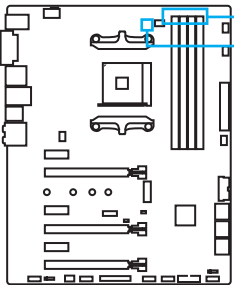

- DIMM LEDs
- GPU LED

PCIe x16 slot LEDs

These LEDs indicate the PCIe x16 slots status.

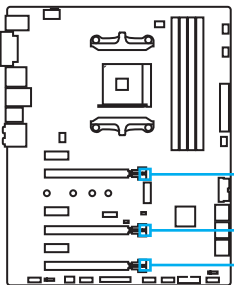

- PCI_E2 LED
- PCI_E4 LED
- PCI_E6 LED

LED Color	PCIe slot status
Red	x16 mode
White	x8, x4, x1 mode

BIOS Setup

The default settings offer the optimal performance for system stability in normal conditions. You should **always keep the default settings** to avoid possible system damage or failure booting unless you are familiar with BIOS.

Important

- *BIOS items are continuously update for better system performance. Therefore, the description may be slightly different from the latest BIOS and should be for reference only. You could also refer to the **HELP** information panel for BIOS item description.*
- *The pictures in this chapter are for reference only and may vary from the product you purchased.*

Entering BIOS Setup

Press **Delete** key, when the **Press DEL key to enter Setup Menu, F11 to enter Boot Menu** message appears on the screen during the boot process.

Function key

- F1:** General Help
- F2:** Add/ Remove a favorite item
- F3:** Enter Favorites menu
- F4:** Enter CPU Specifications menu
- F5:** Enter Memory-Z menu
- F6:** Load optimized defaults
- F7:** Switch between Advanced mode and EZ mode
- F8:** Load Overclocking Profile
- F9:** Save Overclocking Profile
- F10:** Save Change and Reset*
- F12:** Take a screenshot and save it to USB flash drive (FAT/ FAT32 format only).

* When you press F10, a confirmation window appears and it provides the modification information. Select between Yes or No to confirm your choice.

Resetting BIOS

You might need to restore the default BIOS setting to solve certain problems. There are several ways to reset BIOS:

- Go to BIOS and press **F6** to load optimized defaults.
- Short the **Clear CMOS** jumper on the motherboard.



Important

*Be sure the computer is off before clearing CMOS data. Please refer to the **Clear CMOS** jumper section for resetting BIOS.*

Updating BIOS

Updating BIOS with M-FLASH

Before updating:

Please download the latest BIOS file that matches your motherboard model from MSI website. And then save the BIOS file into the USB flash drive.

Updating BIOS:

1. Press Del key to enter the BIOS Setup during POST.
2. Insert the USB flash drive that contains the update file into the computer.
3. Select the **M-FLASH** tab and click on **Yes** to reboot the system and enter the flash mode.
4. Select a BIOS file to perform the BIOS update process.
5. After the flashing process is 100% completed, the system will reboot automatically.

Updating the BIOS with Live Update 6

Before updating:

Make sure the LAN driver is already installed and the Internet connection is set properly.

Updating BIOS:

1. Install and launch MSI LIVE UPDATE 6.
2. Select **BIOS Update**.
3. Click on **Scan** button.
4. Click on **Download** icon to download and install the latest BIOS file.
5. Click **Next** and choose **In Windows mode**. And then click **Next** and **Start** to start updating BIOS.
6. After the flashing process is 100% completed, the system will restart automatically.

EZ Mode

At EZ mode, it provides the basic system information and allows you to configure the basic setting. To configure the advanced BIOS settings, please enter the Advanced Mode by pressing the **Setup Mode switch** or **F7** function key.

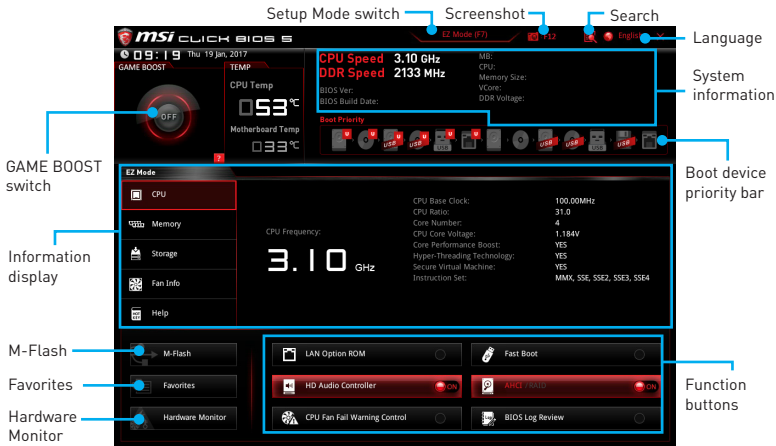

- **GAME BOOST switch** - click on it to toggle the GAME BOOST for OC.

Important

Please don't make any changes in OC menu and don't load defaults to keep the optimal performance and system stability after activating the GAME Boost function.

- **Setup Mode switch** - press this tab or the **F7** key to switch between Advanced mode and EZ mode.
- **Screenshot** - click on this tab or the **F12** key to take a screenshot and save it to USB flash drive (FAT/ FAT32 format only).
- **Search** - click on this tab or the **Ctrl+F** keys and the search page will show. It allows you to search by BIOS item name, enter the item name to find the item listing. Move the mouse over a blank space and right click the mouse to exit search page.

Important

In search page, only the F6, F10 and F12 function keys are available.

- **Language** - allows you to select the language of BIOS setup.
- **System information** - shows the CPU/ DDR speed, CPU/ MB temperature, MB/ CPU type, memory size, CPU/ DDR voltage, BIOS version and build date.
- **Boot device priority bar** - you can move the device icons to change the boot priority. The boot priority from high to low is left to right.
- **Information display** - click on the **CPU**, **Memory**, **Storage**, **Fan Info** and **Help** buttons on left side to display related information.
- **Function buttons** - enable or disable the **LAN Option ROM**, **HD audio controller**, **AHCI**, **RAID**, **CPU Fan Fail Warning Control** and **BIOS Log Review** by clicking on their respective button.

Important

- During windows setup, the RAID driver may be required and you can find the RAID driver in MSI Driver Disc.
- You can use **MSI SMART TOOL** to build the Windows® 7/ 10 installation drive that includes RAID driver.
- If your system currently boots to M.2 SSD RAID and you delete the RAID volume in the UEFI BIOS, your system will become un-bootable.
- **M-Flash** - click on this button to display the **M-Flash** menu that provides the way to update BIOS with a USB flash drive.
- **Hardware Monitor** - click on this button to display the **Hardware Monitor** menu that allows you to manually control the fan speed by percentage.
- **Favorites** - press the **Favorites** tab or the **F3** key to enter **Favorites** menu. It allows you to create personal BIOS menu where you can save and access favorite/ frequently-used BIOS setting items.
 - **Default HomePage** - allows you to select a BIOS menu (e.g. SETTINGS, OC...,etc) as the BIOS home page.
 - **Favorite1~5** - allows you to add the frequently-used/ favorite BIOS setting items in one page.
 - **To add a BIOS item to a favorite page (Favorite 1~5)**
 1. Move the mouse over a BIOS item not only on BIOS menu but also on search page.
 2. Right-click or press **F2** key.
 3. Choose a favorite page and click on **OK**.
 - **To delete a BIOS item from favorite page**
 1. Move the mouse over a BIOS item on favorite page (Favorite 1~5)
 2. Right-click or press **F2** key.
 3. Choose **Delete** and click on **OK**.

Advanced Mode

Press **Setup Mode switch** or **F7** function key can switch between EZ Mode and Advanced Mode in BIOS setup.

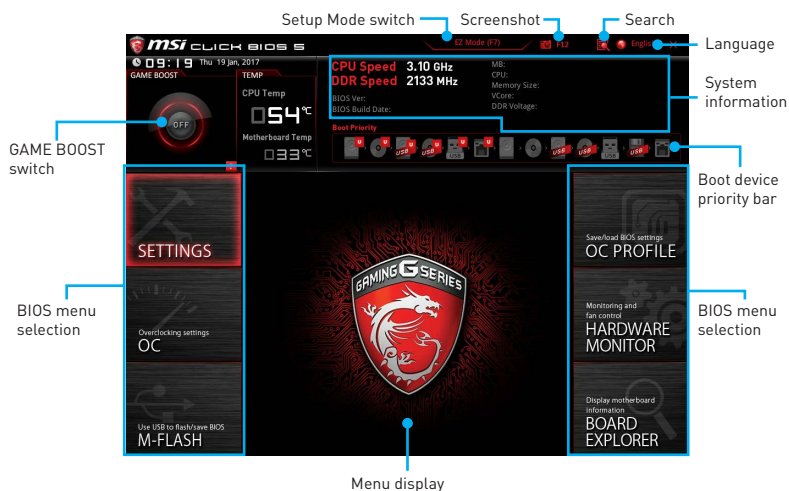

- **GAME BOOST switch/ Setup Mode switch/ Screenshot/ Favorites/ Language/ System information/ Boot device priority bar** - please refer to the descriptions of EZ Mode Overview section.
- **BIOS menu selection** - the following options are available:
 - **SETTINGS** - allows you to specify the parameters for chipset and boot devices.
 - **OC** - allows you to adjust the frequency and voltage. Increasing the frequency may get better performance.
 - **M-FLASH** - provides the way to update BIOS with a USB flash drive.
 - **OC PROFILE** - allows you to manage overclocking profiles.
 - **HARDWARE MONITOR** - allows you to set the speeds of fans and monitor voltages of system.
 - **BOARD EXPLORER** - provides the information of installed devices on this motherboard.
- **Menu display** - provides BIOS setting items and information to be configured.

SETTINGS



System Status

► System Date

Sets the system date. Use tab key to switch between date elements.

The format is <day> <month> <date> <year>.

<day> Day of the week, from Sun to Sat, determined by BIOS. Read-only.

<month> The month from Jan. through Dec.

<date> The date from 1 to 31 can be keyed by numeric function keys.

<year> The year can be adjusted by users.

► System Time

Sets the system time. Use tab key to switch between time elements.

The time format is <hour> <minute> <second>.

► SATA PortX

Shows the information of connected SATA devices.



Important

If the connected SATA device is not displayed, turn off computer and re-check SATA cable and power cable connections of the device and motherboard.

► System Information

Shows detailed system information, including CPU type, BIOS version, and Memory (read only).

► DMI Information

Shows system information, desktop Board Information and chassis Information. (Read only).

Advanced

► PCI Subsystem Settings

Sets PCI, PCI express interface protocol and latency timer. Press **Enter** to enter the sub-menu.

▶ **PCI Latency Timer [32]**

Sets latency timer of PCI interface device.

[Options: 32, 64, 96, 128, 160, 192, 224, 248 PCI Bus clocks]

▶ **ACPI Settings**

Sets ACPI parameters of onboard power LED behaviors. Press **Enter** to enter the sub-menu.

▶ **Power LED [Blinking]**

Sets shining behaviors of the onboard Power LED.

[Dual Color] The power LED turns to another color to indicate the S3 state.

[Blinking] The power LED blinks to indicate the S3 state.

▶ **Integrated Peripherals**

Sets integrated peripherals' parameters, such as LAN, HDD, USB and audio. Press **Enter** to enter the sub-menu.

▶ **Onboard LAN Controller [Enabled]**

Enables or disables the onboard LAN controller.

▶ **LAN Option ROM [Disabled]**

Enables or disables the legacy network Boot Option ROM for detailed settings. This item will appear when **Onboard LAN Controller** is enabled.

[Enabled] Enables the onboard LAN Boot ROM.

[Disabled] Disables the onboard LAN Boot ROM.

▶ **Network Stack [Disabled]**

Sets UEFI network stack for optimizing IPv4 / IPv6 function. This item is available when Onboard LAN Controller is Enabled.

[Enabled] Enables UEFI network stack.

[Disabled] Disables UEFI network stack.

▶ **Ipv4 PXE Support [Enabled]**

When **Enabled**, the system UEFI network stack will support Ipv4 protocol. This item will appear when **Network Stack** is Enabled.

[Enabled] Enables the Ipv4 PXE boot support.

[Disabled] Disables the Ipv4 PXE boot support.

▶ **Ipv6 PXE Support [Enabled]**

When **Enabled**, the system UEFI network stack will support Ipv6 protocol. This item will appear when **Network Stack** is enabled.

[Enabled] Enables the Ipv6 PXE boot support.

[Disabled] Disables the Ipv6 PXE boot support.

▶ **SATA Mode [AHCI Mode]**

Sets the operation mode of the onboard SATA controller.

[AHCI Mode] Specify the AHCI mode for SATA storage devices. AHCI (Advanced Host Controller Interface) offers some advanced features to enhance the speed and performance of SATA storage device, such as Native Command Queuing (NCQ) and hot-plugging.

[RAID Mode] Enables RAID function for SATA storage devices.

▶ **SATAx Hot Plug [Disabled]**

Allows user to enable or disable the SATA hot plug support.

[Enabled] Enables hot plug support for the SATA ports.

[Disabled] Disables hot plug support for the SATA ports.

▶ **HD Audio Controller [Enabled]**

Enables or disables the onboard High Definition Audio controller.

▶ **Integrated Graphics Configuration**

Adjusts integrated graphics settings for optimum system. Press **Enter** to enter the sub-menu.

▶ **Primary Video Adapter [PEG] (optional)**

Selects a graphics device as the primary boot device. This item appears when the installed CPU has iGPU.

[IGD] Integrated Graphics Display.

[PEG] PCI-Express Graphics Device.

▶ **Integrated Graphics [Auto] (optional)**

If set to Force, BIOS will enable the integrated graphics controller.

▶ **UMA Frame Buffer Size [Auto] (optional)**

Selects a fixed amount of system memory allocated to the onboard graphics. This item will be available when **Integrated Graphics** is enabled.

▶ **USB Configuration**

Sets the onboard USB controller and device function. Press **Enter** to enter the sub-menu.

▶ **XHCI Hand-off [Enabled]**

Enables or disables XHCI hand-off support for the operating system without XHCI hand-off feature.

▶ **Legacy USB Support [Enabled]**

Sets Legacy USB function support.

[Auto] The system will automatically detect if any USB device is connected and enable the legacy USB support.

[Enabled] Enable the USB support under legacy mode.

[Disabled] The USB devices will be unavailable under legacy mode.

► Super IO Configuration

Sets system Super I/O chip parameters including LPT and COM ports. Press **Enter** to enter the sub-menu.

► Serial (COM) Port x Configuration

Sets detailed configuration of serial(COM) port x. Press **Enter** to enter the sub-menu.

► Serial (COM) Port x [Enabled]

Enables or disables serial (COM) port x.

► Serial (COM) Port x Settings [Auto]

Sets serial port x (COM). If set to **Auto**, BIOS will optimize the IRQ automatically or you can set it manually.

► Parallel (LPT) Port Configuration

Sets detailed configuration of parallel port (LPT/ LPTE). Press **Enter** to enter the sub-menu.

► Parallel (LPT) Port [Enabled]

Enables or disables parallel(LPT/ LPTE) port.

► Parallel (LPT) Port Settings [Auto]

Sets parallel port (LPT). If set to **Auto**, BIOS will optimize the IRQ automatically or you can set it manually.

► Device Mode [STD Printer Mode]

Selects an operating mode for parallel port.

[STD Printer Mode]	Printer port mode
[SPP]	Standard Parallel Port mode
[EPP-1.9 and SPP Mode]	Enhanced Parallel Port-1.9 mode + Standard Parallel Port mode.

► Power Management Setup

Sets system Power Management of ErP Ready and AC Power Loss behaviors. Press **Enter** to enter the sub-menu.

► ErP Ready [Disabled]

Enables or disables the system power consumption according to ErP regulation.

[Enabled] Optimize the system power consumption according to ErP regulation. It will not support S4 & S5 wake up by USB and PCIe devices.

[Disabled] Disables this function.

► Restore after AC Power Loss [Power Off]

Sets the system behaviors while encountering the AC power loss.

[Power Off] Leaves the system in power off state after restoring AC power.

[Power On] Boot up the system after restoring AC power.

[Last State] Restores the system to the previous state (power on/ power off) before AC power loss.

▶ **System Power Fault Protection [Disabled]**

Enables or disables the system to boot up when detecting abnormal voltage input.

[Enabled] Protect the system from unexpected power operating and remain the shut down status.

[Disabled] Disables this function.

▶ **Windows OS Configuration**

Sets Windows detailed configuration and behaviors. Press **Enter** to enter the sub-menu.

▶ **Windows 10 WHQL Support [Disabled]**

Enables the supports for Windows 10 or disables for other operating systems. Before enabling this item, make sure all installed devices & utilities (hardware & software) should meet the Windows 10 requirements.

[Enabled] The system will switch to UEFI mode to meet the Windows requirement.

[Disabled] Disables this function.

▶ **Internal GOP Configuration**

Manages the onboard Graphics Output Protocol (GOP). Press **Enter** to enter the sub-menu. This sub-menu will appear when **Windows 10 WHQL Support** is enabled.

▶ **Secure Boot**

Sets the Windows secure boot to prevent the unauthorized accessing. Press **Enter** to enter the sub-menu. This sub-menu will appear when **Windows 10 WHQL Support** is enabled.

▶ **Wake Up Event Setup**

Sets system wake up behaviors for different sleep modes. Press **Enter** to enter the sub-menu.

▶ **Wake Up Event By [BIOS]**

Selects the wake up event by BIOS or operating system.

[BIOS] Activates the following items, set wake up events of these items.

[OS] The wake up events will be defined by OS.

▶ **Resume By RTC Alarm [Disabled]**

Disables or enables the system wake up by RTC Alarm.

[Enabled] Enables the system to boot up on a scheduled time/ date.

[Disabled] Disables this function.

▶ **Date (of month) Alarm/ Time (hh:mm:ss) Alarm**

Sets RTC alarm date/ Time. If Resume By RTC Alarm is set to [Enabled], the system will automatically resume (boot up) on a specified date/hour/minute/second in these fields (using the + and - keys to select the date & time settings).

▶ **Resume By PCI-E Device [Disabled]**

Enables or disables the wake up function of installed PCI/ PCI-E expansion cards, integrated LAN controllers or USB devices which are supported by third party integrated chips.

[Enabled] Enables the system to be awakened from the power saving modes when activity or input signal of PCI/ PCIe device is detected.

[Disabled] Disables this function.

▶ **Resume by USB Device [Disabled]**

Disables or enables system wake up from S3/S4 by USB device.

[Enabled] Enables the system to be awakened from sleep state when activity of USB device is detected.

[Disabled] Disables this function.

▶ **Resume From S3/S4/S5 by PS/2 Mouse [Disabled]**

Enables or disables the system wake up by PS/2 mouse.

[Enabled] Enables the system to be awakened from S3/ S4/ S5 state when activity of PS/2 mouse is detected.

[Disabled] Disables this function.

▶ **Resume From S3/S4/S5 by PS/2 Keyboard [Disabled]**

Enables or disables the system wake up by PS/2 keyboard.

[Any Key] Enables the system to be awakened from S3/ S4/ S5 state when activity of any key on PS/2 keyboard is detected.

[Hot Key] Enables the system to be awakened from S3/ S4/ S5 state when activity of hot key on PS/2 keyboard is detected.

[Disabled] Disables this function.

▶ **Hot Key [Ctrl+Space]**

Selects a combination of keys as a hot key to wake the system. This item appears when you set the **Resume From S3/S4/S5 by PS/2 Keyboard** to **Hot Key**.

▶ **Secure Erase+**

Enables or disables Secure Erase+ function. **Secure Erase+** is the best way to effectively wipe all data from a SSD. Please note that data of SSD will be erased after enabling **Secure Erase+**.

▶ **Realtek PCIe GBE Family Controller**

Shows driver information and configuration of the ethernet controller parameter.

Boot

Sets the sequence of system boot devices.

▶ **Full Screen Logo Display [Enabled]**

Enables or disables to show the full screen logo while system POST.

[Enabled] Shows the logo in full screen.

[Disabled] Shows the POST messages.

▶ **Bootup NumLock State [On]**

Select the keyboard NumLock state upon bootup.

▶ **Info Block effect [Unlock]**

Sets the state of **Help** information block.

[Unlock] Sliding effect.

[Lock] Fix the **Help** information block on the screen.

▶ **AUTO CLR_CMOS [Disabled]**

Enables or disables the CMOS data to be resumed automatically when the system cannot boot to OS and reboot repeatedly.

▶ **Boot Mode Select [LEGACY+UEFI]**

Sets the system boot mode from legacy or UEFI architecture depending on OS installation requirement. This item will become un-selectable and will be configured automatically by BIOS when **Windows 10 WHQL Support** is enabled.

[UEFI] Enables UEFI BIOS boot mode support only.

[LEGACY+UEFI] Enables both Legacy BIOS boot mode and UEFI BIOS boot mode.

▶ **FIXED BOOT ORDER Priorities**

Sets device priority for system boot.

▶ **Boot Option Priorities**

These items are used to prioritize the installed boot devices.

Security

▶ **Administrator Password**

Sets administrator password for system security. User has full rights to change the BIOS items with administrator password. After setting the administrator password, the state of this item will show **Installed**.

▶ **User Password**

Sets User Password for system security. User has limited rights to change the BIOS items with user password. This item will be available when administrator password is set. After setting the user password, the state of this item will show **Installed**.

▶ **Password Check [Setup]**

Selects a condition that will request the password.

[Setup] A password will be requested for entering the BIOS Setup.

[Boot] A password will be requested for booting the system.

▶ **Password Clear [Enabled]**

Enables or disables the clear CMOS behavior to clear a set password.

[Enabled] The password will be erased after clear CMOS.

[Disabled] The password will always be kept.

Important

When selecting the Administrator / User Password items, a password box will appear on the screen. Type the password then press **Enter**. The password typed now will replace any previous set password from CMOS memory. You will be prompted to confirm the password. You may also press **Esc** key to abort the selection.

To clear a set password, press **Enter** when you are prompted to enter a new password. A message will confirm the password is being disabled. Once the password is disabled, you can enter the setup and OS without authorization.

▶ **Trusted Computing**

Sets TPM (Trusted Platform Module) function.

▶ **Security Device Support [Disabled]**

Enables or disables the TPM function to build the endorsement key for accessing the system.

▶ **AMD fTPM switch [AMD CPU fTPM]**

Selects TPM device.

[AMD CPU fTPM] Select it for AMD Firmware TPM.

[AMD CPU fTPM Disabled] Select it for Discrete TPM.

▶ **Device Select [Auto]**

Sets the version of the TPM device. The version must be identical with the device. Sets to **Auto**, system will detect the TPM2.0 or TPM1.2 model automatically.

▶ **Chassis Intrusion Configuration**

Press **Enter** to enter the sub-menu.

▶ **Chassis Intrusion [Disabled]**

Enables or disables recording messages while the chassis is opened. This function is ready for the chassis equips a chassis intrusion switch.

[Enabled] Once the chassis is opened, the system will record and issue a warning message.

[Reset] Clear the warning message. After clearing the message, please return to **Enabled** or **Disabled**.

[Disabled] Disables this function.

Save & Exit

▶ **Discard Changes and Exit**

Exit BIOS setup without saving any change.

▶ **Save Changes and Reboot**

Save all changes and reboot the system.

▶ **Save Changes**

Save current changes.

▶ **Discard Changes**

Discard all changes and restore to the previous values.

▶ **Restore Defaults**

Restore or load all default values.

▶ **Boot Override**

The installed boot-able devices will appear on this menu, you can select one of them to be the boot device.

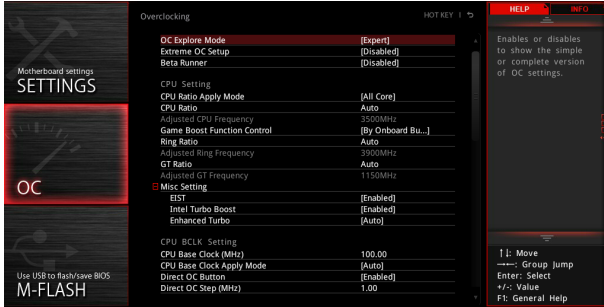

! Important

- Overclocking your PC manually is only recommended for advanced users.
- Overclocking is not guaranteed, and if done improperly, it could void your warranty or severely damage your hardware.
- If you are unfamiliar with overclocking, we advise you to use **GAME BOOST** function for easy overclocking.

▶ OC Explore Mode [Normal]

Enables or disables to show the normal or expert version of OC settings.

[Normal] Provides the regular OC settings in BIOS setup.

[Expert] Provides the advanced OC settings for OC expert to configure in BIOS setup.

Note: We use * as the symbol for the OC settings of Expert mode.

▶ CPU Frequency [Auto]

Sets the CPU frequency.

▶ Core Performance Boost [Auto]

Enables or disables the Core Performance Boost (CPB). This item appears when the installed CPU supports this function.

▶ Downcore Control [Auto] (optional)

Sets the number of processor cores to be used. This item appears when the installed CPU supports this function.

▶ DRAM Frequency [Auto]

Sets the DRAM frequency. Please note the overclocking behavior is not guaranteed.

▶ Adjusted DRAM Frequency

Shows the adjusted DRAM frequency. Read-only.

▶ Advanced DRAM Configuration

Press **Enter** to enter the sub-menu. User can set the memory timing for each/ all memory channel. The system may become unstable or unbootable after changing memory timing. If it occurs, please clear the CMOS data and restore the default settings. (Refer to the Clear CMOS jumper/ button (optional) section to clear the CMOS data, and enter the BIOS to load the default settings.)

► DigitALL Power

Press **Enter** to enter the sub-menu. Controls the digital powers related to CPU PWM.

► CPU Loadline Calibration Control [Auto]

The CPU voltage will decrease proportionally according to CPU loading. Higher load-line calibration could get higher voltage and good overclocking performance, but increase the temperature of the CPU and VRM. If set to **Auto**, BIOS will configure this setting automatically.

► CPU NB Loadline Calibration Control [Auto]

The CPU-NB voltage will decrease proportionally according to CPU-NB loading. Higher load-line calibration could get higher voltage and good overclocking performance, but increase the temperature. If set to **Auto**, BIOS will configure this setting automatically.

► CPU Over Voltage Protection [Auto]

Sets the voltage limit for CPU over-voltage protection. If set to **Auto**, BIOS will configure this setting automatically. Higher voltage provides less protection and may damage the system.

► CPU Under Voltage Protection [Auto]

Sets the voltage limit for CPU under-voltage protection. If set to **Auto**, BIOS will configure this setting automatically. Higher voltage provides less protection and may damage the system.

► CPU Over Current Protection [Auto]

Sets the current limit for CPU over-current protection. If set to **Auto**, BIOS will configure this setting automatically.

[Auto] This setting will be configured automatically by BIOS.

[Enhanced] Extends the current range for over-current protection.

► VR 12VIN OCP Expander [Auto]

Expands the limitation of VR Over Current Protection with 12V input voltage. The higher expanding value indicates less protection. Therefore, please adjust the current carefully if needed, or it may damage the CPU/VR MOS. If set to "Auto", BIOS will configure this setting automatically.

► CPU Voltages control [Auto]

These options allows you to set the voltages related to CPU. If set to **Auto**, BIOS will set these voltages automatically or you can set it manually.

► DRAM/PROM Voltages control [Auto]

These options allows you to set the voltages related to memory. If set to **Auto**, BIOS will set these voltages automatically or you can set it manually.

► CPU Memory Changed Detect [Enabled]*

Enables or disables the system to issue a warning message during boot when the CPU or memory has been replaced.

[Enabled] The system will issue a warning message during boot and then you have to load the default settings for new devices.

[Disabled] Disables this function and keeps the current BIOS settings.

▶ CPU Specifications

Press **Enter** to enter the sub-menu. This sub-menu displays the information of installed CPU. You can also access this information menu at any time by pressing [F4]. Read only.

▶ CPU Technology Support

Press **Enter** to enter the sub-menu. The sub-menu shows the key features of installed CPU. Read only.

▶ MEMORY-Z

Press **Enter** to enter the sub-menu. This sub-menu displays all the settings and timings of installed memory. You can also access this information menu at any time by pressing [F5].

▶ DIMMx Memory SPD

Press **Enter** to enter the sub-menu. The sub-menu displays the information of installed memory. Read only.

▶ CPU Features

Press **Enter** to enter the sub-menu.

▶ AMD Cool' n' Quiet [Enabled]

The Cool' n' Quiet technology can effectively and dynamically lower CPU speed and power consumption.

▶ SVM Mode [Disabled]

Enables/ disables the AMD SVM (Secure Virtual Machine) Mode.

▶ Core C6 state [Enabled]

Enables/disables the C6 state.

M-FLASH

M-FLASH provides the way to update BIOS with a USB flash drive. Please down-load the latest BIOS file that matches your motherboard model from MSI website, save the BIOS file into your USB flash drive. And then follow the steps below to update BIOS.

1. Insert the USB flash drive that contains the update file into the computer.
2. Click on **M-FLASH** tab, a demand message will be prompted. Click on **Yes** to reboot and enter the flash mode.

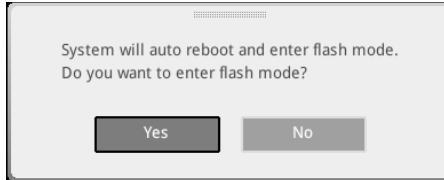

3. The system will enter the flash mode and a file selection menu will appear after rebooting.

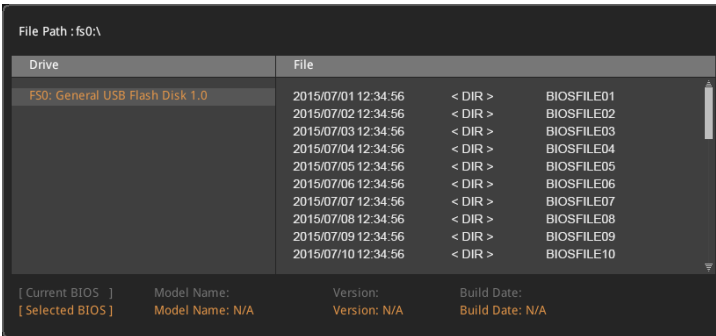

4. Select the BIOS file.
5. A message will prompt you to toggle the Multi BIOS switch to the target BIOS ROM, and then click **OK** to perform the BIOS update process.



6. After the flashing process is 100% completed, the system will reboot automatically.

OC PROFILE



► Overclocking Profile 1/ 2/ 3/ 4/ 5/ 6

Overclocking Profile 1/ 2/ 3/ 4/ 5/ 6 management. Press <Enter> to enter the sub-menu.

► Set Name for Overclocking Profile 1/ 2/ 3/ 4/ 5/ 6

Name the current overclocking profile.

► Save Overclocking Profile 1/ 2/ 3/ 4/ 5/ 6

Save the current overclocking profile.

► Load Overclocking Profile 1/ 2/ 3/ 4/ 5/ 6

Load the current overclocking profile.

► Clear Overclocking Profile 1/ 2/ 3/ 4/ 5/ 6

Clear the current overclocking profile.

► OC Profile Load from ROM

Load OC profile from BIOS ROM.

► OC Profile Save to USB

Save OC profile to the USB flash drive. The USB flash drive should be FAT/ FAT32 format only.

► OC Profile Load from USB

Load OC profile from the USB flash drive. The USB flash drive should be FAT/ FAT32 format only.

HARDWARE MONITOR



► Temperature & Speed

Shows the current CPU temperature, system temperature and fans' speeds.

► Fan Manage

- **PWM** - allows you to select the PWM mode for fan operation.
- **DC** - allows you to select the DC mode for fan operation.
- **Auto** - allows you to select the Auto-detection mode for fan operation.
- **Fan step up/ down time** - allows you to set the period of fan step up/ down.
- **Smart Fan Mode field** - allows you to drag the gradient points to configure the fan target values for **Smart Fan** mode. **Smart Fan** can control the fan speed automatically depending on the CPU temperature to keep it within a specific range. If the current CPU temperature reaches to the target value, the **Smart Fan** function will be activated.

! Important

- The changing will achieve after you save the changes and reboot the system.
- Make sure fans are working properly after switching the PWM/ DC mode.

► Settings Buttons

- **All Full Speed** - configures all fans to run at full operating speed.
- **All Set Default** - configures all fans to run at default operating speed.
- **All Set Cancel** - discards current changes and restores previous operating fan speeds .

► Voltage display

Shows the current voltages of CPU, system and memory.

Software Description

Please download and update the latest utilities and drivers at www.msi.com

Installing Windows® 7 64-bit/ Windows® 10 64-bit

1. Power on the computer.
2. Insert the Windows® 7/ 10 disc into your optical drive.
Note: Due to chipset limitation, during the Windows 7 installation process, USB optical drives or USB flash drives are not supported. You can use **MSI Smart Tool** to install Windows® 7.
3. Press the **Restart** button on the computer case.
4. Press **F11** key during the computer POST (Power-On Self Test) to get into Boot Menu.
5. Select your optical drive from the Boot Menu.
6. Press any key when screen shows **Press any key to boot from CD or DVD...** message.
7. Follow the instructions on the screen to install Windows® 7/ 10.

Installing Drivers

1. Start up your computer in Windows® 7/ 10.
2. Insert MSI® Driver Disc into your optical drive.
3. The installer will automatically appear and it will find and list all necessary drivers.
4. Click **Install** button.
5. The software installation will then be in progress, after it has finished it will prompt you to restart.
6. Click **OK** button to finish.
7. Restart your computer.

Installing Utilities

Before you install utilities, you must complete drivers installation.

1. Insert MSI® Driver Disc into your optical drive.
2. The installer will automatically appear.
3. Click **Utilities** tab.
4. Select the utilities you want to install.
5. Click **Install** button.
6. The utilities installation will then be in progress, after it has finished it will prompt you to restart.
7. Click **OK** button to finish.
8. Restart your computer.

LIVE UPDATE 6

LIVE UPDATE 6 is an application for the MSI® system to scan and download the latest drivers, BIOS and utilities. With LIVE UPDATE 6, you don't need to search the drivers on websites, and don't need to know the models of motherboard and graphics cards. LIVE UPDATE 6 will download the appropriate drivers automatically.

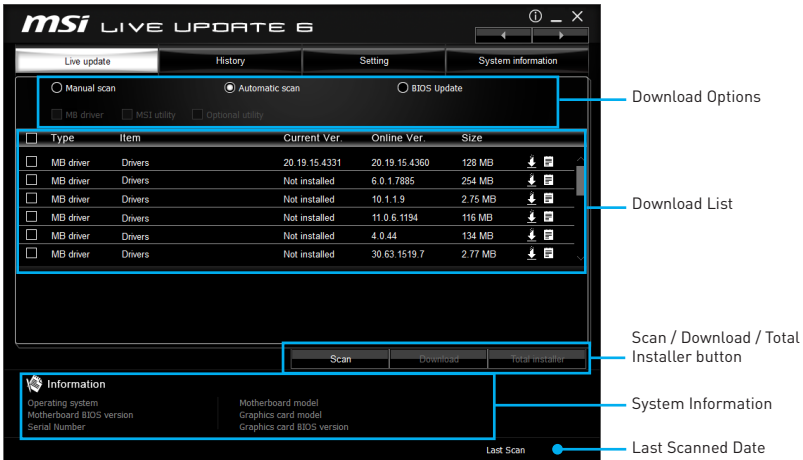

There are **Live Update**, **History**, **Setting** and **System Information** tabs at the top. You can click the tab to switch the control panel.

- **Live Update** - When you launch LIVE UPDATE 6, you will see the Live update tab at first. This tab allows you to select files to download. You can also read the relevant information by clicking the information icon  on the right of the item listed.
- **History** - shows the downloading history.
- **Setting** - allows you to specify the frequency that LIVE UPDATE 6 remind you to update.
- **System Information** - displays the information of the system.
- **FAQ** - shows Frequently Asked Questions.
- **Online Help** - shows Online Help information.

Updating The System

This section describes how to update your system with LIVE UPDATE 6. Please follow the steps below:

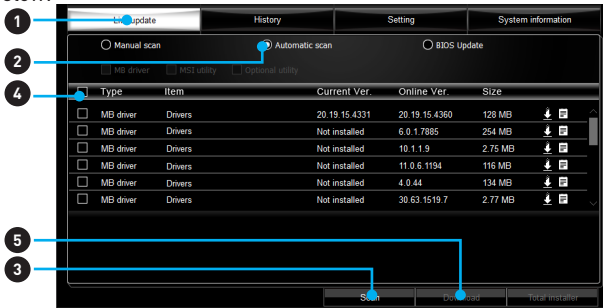

1. Select the **Live Update** tab.
2. Choose **Automatic scan**, system will automatically scan all the items and search for the latest update files. Or you can choose **Manual scan** and select the items you wish to scan.
3. Click the **Scan** button at the bottom. It may take several moments to complete the process.
4. When the download list appears, please select the items you intend to update.
5. Click **Download** button at the bottom.
6. When **Save Path** prompt, you can specify a download directory.

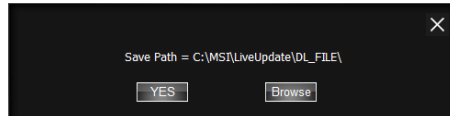

7. When downloading you will see the screen below. It may take several moments to complete the process.

Type	Item	Latest Ver.	Size	Download
MSI utility	MSI utility	1.0.1.5	1.52 MB	<div style="width: 46%;"></div> 46 %
MSI utility	MSI utility	1.2.026	3.21 MB	

8. To install the applications, simply unpack the packages and install.

Total Installer

Total Installer is a convenient feature to simplify frequent installing procedure. To use Total Installer:

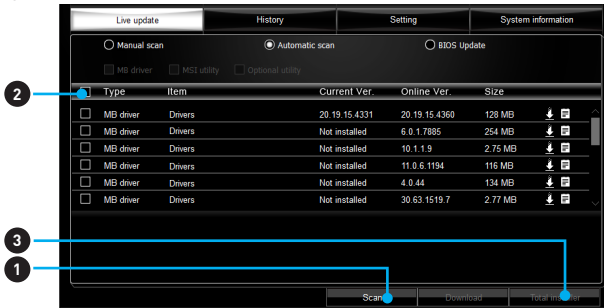

1. **Scan** updates in **Live Update** tab.
2. Check the **Select All** check-box you intend to update.
3. Click the **Total Installer** button. LIVE UPDATE 6 will automatically install them.
4. When prompted, click **OK** to complete the Total Installer procedure
5. Reboot your system.

COMMAND CENTER

COMMAND CENTER is a user-friendly software and exclusively developed by MSI, helping users to adjust system settings and monitor status under OS. With the help of COMMAND CENTER, making it possible to achieve easier and efficient monitoring process and adjustments than that under BIOS. In addition, the COMMAND CENTER can be a server for mobile remote control application.

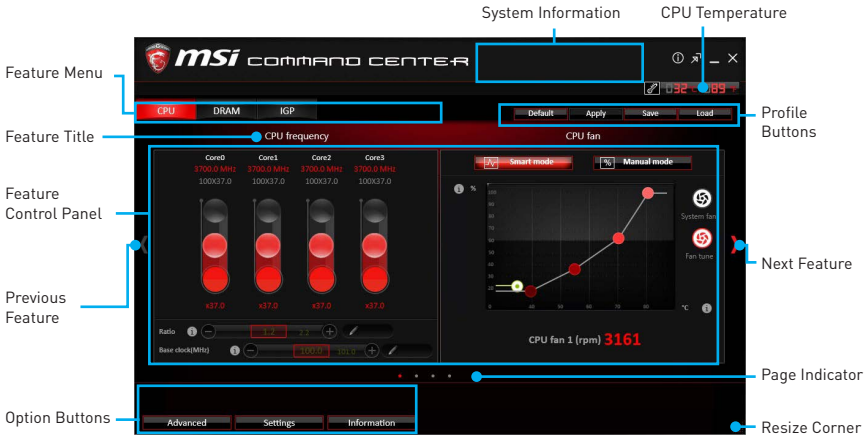

Profile Buttons



- **Default** - load the default values for the current feature.
- **Apply** - apply your changes.
- **Save** - store values in the file with individual file extension.
- **Load** - load the values from the file.

Important

Every time you shut down the system, the configured setting will be restored to the factory default. If you want to use the saved settings, you have to load it every time by clicking the **Load** and **Apply** buttons.

CPU Frequency

CPU Frequency control panel allows you to change CPU Ratio and Base clock. You can see the current frequency of each CPU core on the top of the panel.

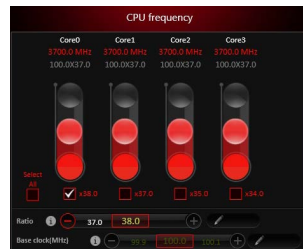

CPU Fan

CPU Fan control panel provides **Smart mode** and **Manual Mode**. You can switch the control mode by clicking the **Smart Mode** and **Manual Mode** buttons on the top of the CPU Fan control panel.

- **Manual Mode** - allows you to manually control the CPU fan speed by percentage.
- **Smart Mode** - a linear fan speed control feature. The control panel contains 4 dots allows you to drag and adjust the Smart Speed slopes. The fan speed will be changed along these lines with CPU temperature. The white dot will create strip chart in real time.
- **System Fan Button** - to open the system fan control panel in new window.
- **Fan Tune Button** - to automatically optimize the smart fan setting.

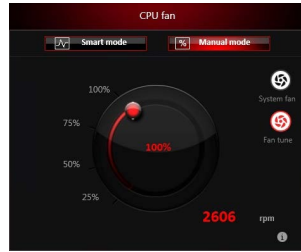

Manual Mode

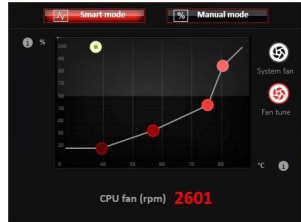

Smart Mode

CPU Voltage

CPU Voltage control panel allows you to control the CPU voltage.



DRAM Frequency & DRAM Voltage

- **DRAM Frequency** - Shows the DRAM clock, ratio and frequency.
- **DRAM Voltage** - Allows you to adjust the DRAM voltage. The risky values are displayed in red.



IGP Frequency & GT Voltage

- **IGP Frequency** - Allows you to adjust the IGP ratio, and shows the IGP clock, ratio and frequency.
- **GT Voltage** - Allows you to adjust the GT voltage. The risky values are displayed in red.

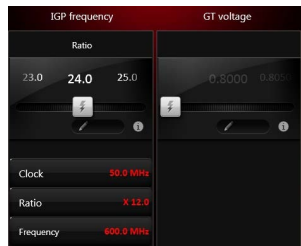

GAME BOOST

GAME BOOST provides a specified CPU frequency for overclocking the CPU.



Option Buttons - Advanced

When click the **Advanced** button, The **Voltage**, **Fan**, **DRAM** and **Sensor** icons will appear.



- **Voltage** - allows you to adjust advanced voltage values of CPU and chipset.
- **Fan** - allows you to control the system fans speed.
- **DRAM** - shows the current Advanced DRAM parameters, and allows you to change the settings by selecting values from the drop-down menu on the right hand side.
- **Sensor** - allows you to monitor your motherboard temperature and fan speed with the virtual thermal image. You can drag and drop the fan icons to new locations. When you press the **Cooling** button, all fans will run at full speed.

Option Buttons - Setting

When click the **Setting** button, The **Record**, **Warning** and **Mobile Control** icons will appear.



- **Record** - allows you to monitor the status of voltage, fan speed and temperature in real time.
 - To filter record charts, select the check box next to the items.
 - When click the **Play** button, the chart pane will start to show the recording chart. If you want to check the value of a specific spot on chart, please move the orange vertical line to the spot.
 - History Record stores the data and names with date and time.
 - To make a history record: Select items and click the **Record** button. When finished, click the **Record** button again. The data will be stored in the drop-down menu.
 - To load a record, click the drop-down menu and select one from the list.
 - To delete a record, select the record that you want to delete, and click the **Trash Can** icon.

- **Warning** - contains fields of voltage, fan speed and temperature for you to set the threshold values. When system detects the status over your settings, a warning message will pop-up.

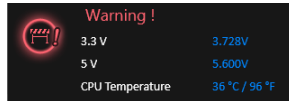

- **Mobile Control** - is only available for the motherboard with the built-in WiFi module. It allows you to enable/disable the COMMAND CENTER Remote Server. Please refer to the instruction on the Mobile Control control panel. **To start remote control: (optional)**

1. Download and install **MSI® COMMAND CENTER APP** to your mobile device.
2. Enable **COMMAND CENTER Remote Server** on the **Mobile Control** panel.
3. Enable **SoftAP Management**.
4. Enter **SSID** and **Password**, and then click the **Apply** button.
5. Activate Wi-Fi® on your mobile device and connect to SoftAP with the SSID.
6. Run **MSI® COMMAND CENTER APP** on your mobile device.
7. Find the IP address on the **SoftAP Management Setting** area, and enter the IP address on your **MSI® COMMAND CENTER APP** to link your system.
8. Press **Refresh** on the **MSI® COMMAND CENTER APP** to verify that monitoring and OC functions are working properly.

Option Buttons - Information

When click the **Information** button, The **Motherboard, CPU, Memory** and **HW monitor** icons will appear.



You can click the icons to open the related information.

Gadget Mode

COMMAND CENTER provides a gadget mode to monitor the system status. You can switch between gadget mode and full mode by clicking the arrow icon  on the top left.

- **To arrange gadgets:**

1. Click the Spanner icon  on the Gadget mode, a configuration panel will slide out.
2. Select the check box next to the items.
3. Click the **Close** button.

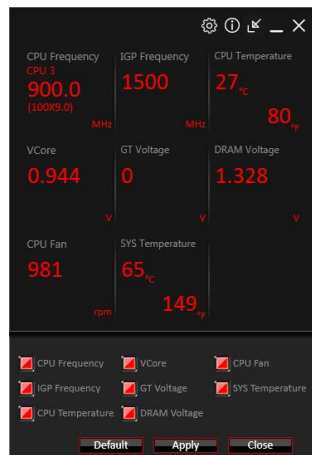

GAMING APP

GAMING APP is an application designed to quickly control your system for improving gaming performance.

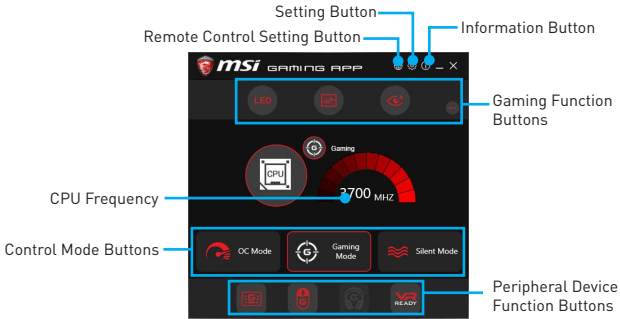

- **Setting Button** - allows you to choose running GAMING APP when Windows starts or let GAMING APP to overwrite the VGA fan control function.
- **Information Button** - shows the information of this application.
- **CPU Frequency** - shows the current CPU frequency.
- **Control Mode Buttons**
 - **OC Mode** - apply turbo frequency to CPU and OC frequency to GPU.
 - **Gaming Mode** - automatically optimize the CPU ratio and the GPU clock.
 - **Silent Mode** - reverts the CPU ratio and GPU clock to the default values.
 - **Gaming Function Buttons** - allows you to use **LED Effect**, **OSD** and **Eye Rest** functions.
- **Peripheral Device Function Buttons** - allows you to set the **Gaming Hotkey**, **Mouse Master** and **VR Ready** functions.
- **Remote Control Setting Button** - available for the motherboards with built-in or discrete WiFi module. It allows you to set up **Name** and **Password** to link the android device and the motherboard. Please follow the steps below to complete the remote control setting.
 1. Download and install the **MSI® GAMING APP** APP to your android device.
 2. Set up a set of **Name** and **Password** on the **Remote Control Setting** panel, and then click the **Apply** button.
 3. Connect your android device and motherboard to the same local area network.
 4. Run **MSI® GAMING APP** APP on your android device.
 5. Press the **Remote Control Setting** icon on the **MSI® GAMING APP** APP to find the paired device **Name** you set in the **Remote Control Setting** panel.
 6. Enter the **Password** you set in the **Remote Control Setting** panel.
 7. Finally, you can use the **MSI® GAMING APP** APP to control your motherboard with the android device.

LED

LED function allows you to control LED lights on your motherboard.

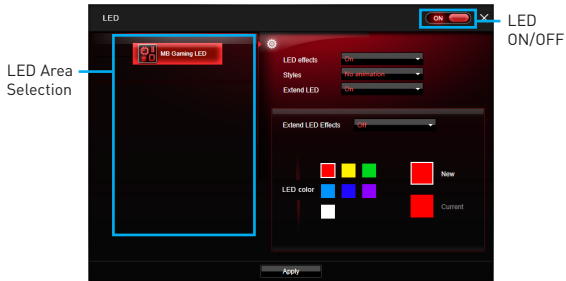

- **LED ON/OFF** - allows you to turn ON/ OFF the **LED** function.
- **LED Area Selection** - separately controls each segment of LEDs on your motherboard and graphics cards.
- **LED effects** - switches LEDs on or off.
- **Styles** - select the LED style from the drop-down list.
- **Music** (optional) - flashes the LED light with music's beat.
- **Extend LED** (optional) - allows you to turn ON/ OFF the Extend LED Effects.
 - **Extend LED Effects** - select extend LED strip effect.
- **LED color** (optional) - allows you change the LED color.
- **Apply Button** - applies above settings to LEDs.

OSD Setting Panel

Use the OSD setting panel to specify information within on-screen display (OSD).

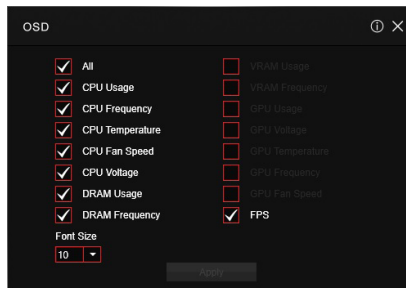

- **Apply Button** - applies above settings to OSD.

Eye Rest

Eye Rest allows you to optimize the display on your monitor.

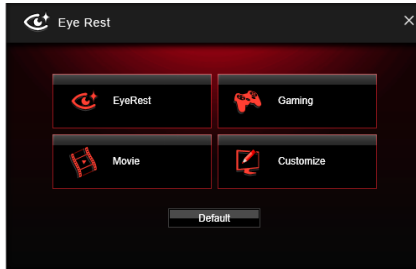

- **EyeRest** - reduces blue-light of your LED backlit screen, in order to protect your eyes.
- **Gaming** - automatically increases contrast ratio of your screen.
- **Movie** - automatically increases dynamic contrast ratio of your screen.
- **Customize** - allows you to adjust gamma, contrast and color balance for your screen.
- **Default** - loads the default settings.

VR Ready

It will optimize the performance of your system to ensure everything is VR Ready.

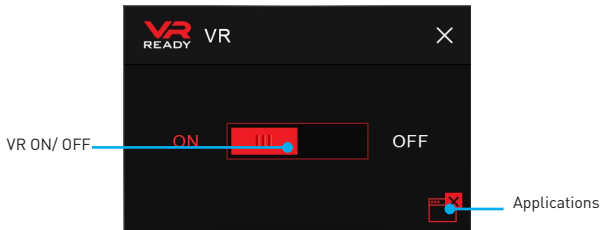

- **VR ON/ OFF** -enables or disables VR settings.
- **Applications** - appears when you turn on the VR support. It allows you to close some applications to optimize the system for better VR experience.

Gaming Hotkey

Gaming Hotkey provides instant control of the system through user defined hotkeys.

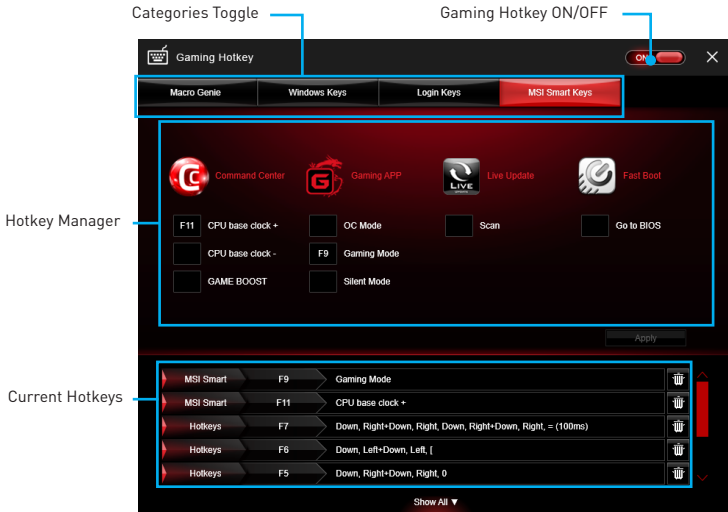

- **Gaming Hotkey ON/OFF** - allows you to turn ON/OFF the Gaming Hotkey function.
- **Categories Toggle** - allows you to toggle over the Hotkey categories.
 - **Macro Genie** - provides the keyboard and mouse macro record function and allows you to define the hotkeys for the macro recorder.
 1. Click on the **Record** button to start the keyboard and mouse macro recorder.
 2. Click on the **Stop** button to stop the recorder.
 3. Key-in a file name and set-up the parameter for the macro.
 4. Finally, click on the **Save** button to save the recorded macro.
 - **Windows Keys** - allows you to define hotkeys to replace Windows default keyboard shortcuts.
 - **Login Keys** - provides hotkey login function.
 - **MSI Smart Keys** - allows you to define hotkeys for MSI Smart Keys.
- **Hotkey Manager** - allows you to create, edit and delete hotkeys.
- **Current Hotkeys** - shows all existing hotkeys.

Important

- The **Caps Lock**, **Num Lock**, **Scroll Lock**, **Window Home**, **Application** and **BackSpace** keys can not be used as Hotkeys.
- Some key combinations are reserved for use by Microsoft Windows and can not be assigned as a hotkey.

Mouse Master

Mouse Master provides mouse macro function. You can also use it to change DPI of your mouse.

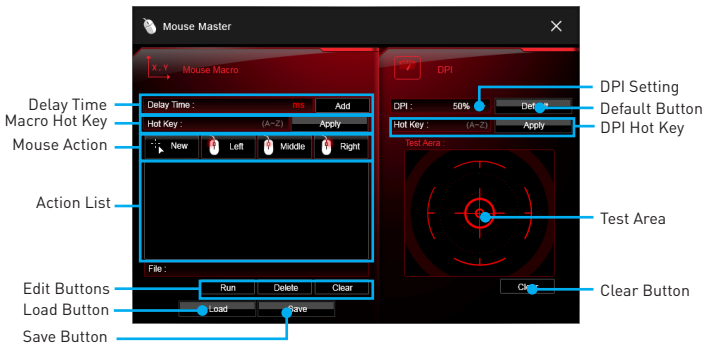

- **Delay Time** - allows you to apply a delay time in mouse macro.
- **Macro Hot Key** - allows you to assign a hotkey from A to Z to activate the macro.
- **Mouse Action** - assigns mouse actions to the macro.
 - **New** - captures the mouse coordinate and add to the macro.
 - **Left** - adds a left-click to the macro.
 - **Middle** - adds a middle-click to the macro.
 - **Right** - adds a right-click to the macro.
- **Action List** - shows the actions of the current macro.
- **Edit Buttons** - there 3 buttons for editing the macro.
 - **Run** - activates the macro.
 - **Delete** - removes the selected action from the macro.
 - **Clear** - removes all actions from the macro.
- **Load Button** - allows you to load a macro.
- **Save Button** - allows you to save the macro to a file.
- **DPI Setting** - allows you select the mouse DPI from the drop-down menu.
- **Default Button** - reverts to the default DPI setting.
- **DPI Hot Key** - allows you to assign a hotkey from A to Z to activate the DPI setting. Please note that you must hold the hotkey to keep the DPI setting. When you release the hotkey, the DPI setting will be reverted to default.
- **Test Area** - allows you to test the mouse movement.
- **Clear Button** - clears the test area.

RAMDISK

RAMDISK creates a virtual RAM drive using the available memory in your computer, the performance of the RAMDISK is faster than an SSD and hard drive. RAMDISK allows you to store any temporary information on it. Furthermore, using the RAMDISK will extend your SSD's life by sparing it from excessive reading and writing.

Creating a RAM Disk

When **RAMDISK** is started, it will create a default RAM disk. If you want to change settings, refer to following instructions.

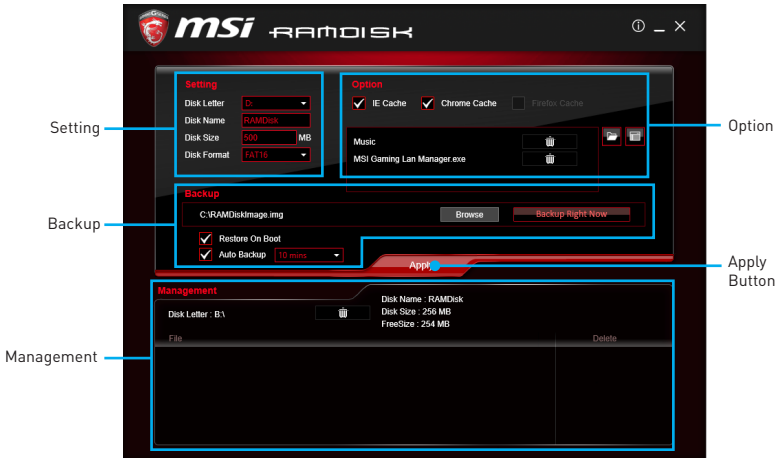

- **Setting** - specify **Letter, Name, Size and Format** of the RAM disk.
- **Option** - select browser temporary files to save/load on the RAM disk. You can also add software files to improve reading speed.
- **Backup** - specify backup and restore settings to prevent data loss. All files will be lost each time the RAMDISK is stopped if you do not backup.
 - **Browse Button** - set the path to the image file.
 - **Backup Right Now Button** - manually backup files.
 - **Restore On Boot** - check this box to have the image file loaded automatically when RAMDISK starts.
 - **Auto Backup** - check this box to backup automatically over a period of time.
- **Apply Button** - allows you to apply changes.
- **Management** - shows RAMDISK information and allows you to delete files.

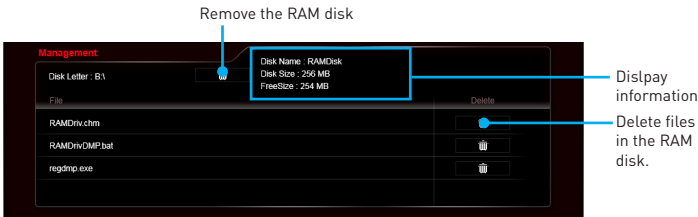

X-BOOST

The MSI **X-BOOST** allows you to select the system performance mode to meet your current system environment or supports faster storage access speed. Most of the external storage and memory cards can also benefit this feature.

Easy

In **Easy** page, you can select one system performance mode to meet the current system environment.

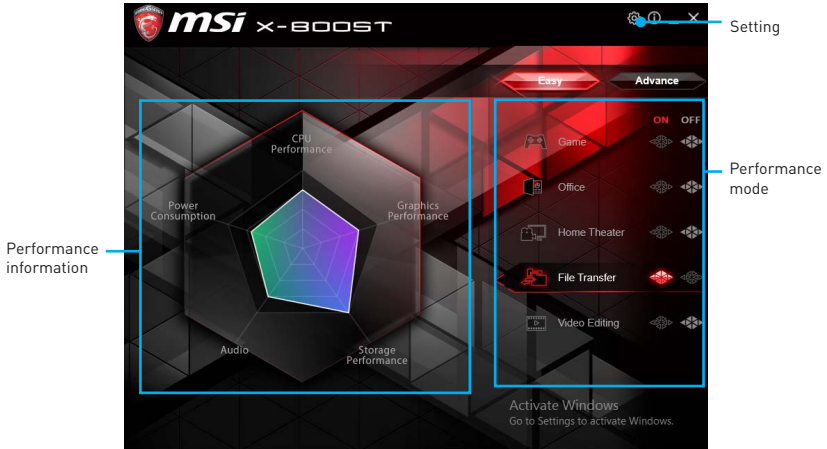

- **Performance mode** - moves over the mouse to any one of performance mode and click on the **ON** button to enable it.
- **Performance information** - displays the system performance diagram of enabled mode.
- **Setting** - enables or disables **Run X-BOOST when windows starts**.

Advance

In **Advance** page, you can enable the **USB SPEED UP** and/or the **STORAGE BOOST**.

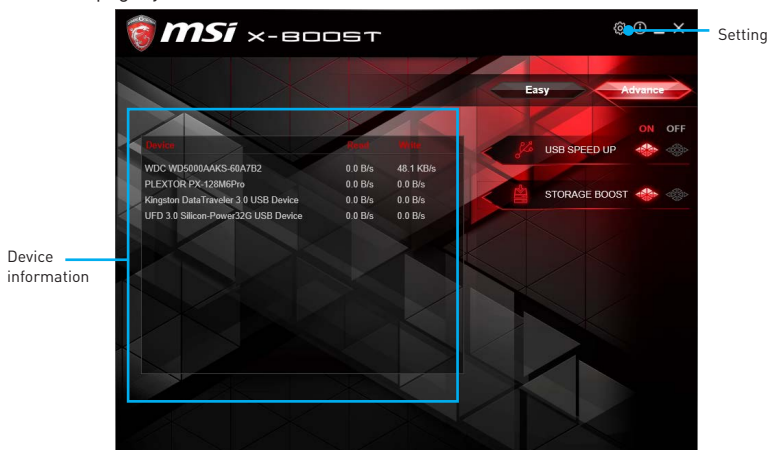

- **Device information** - displays the information and current transfer rates/ access speeds of USB/ storage devices.
- **Setting** - enables or disables **Run X-BOOST when windows starts**.
- **USB SPEED UP** - supports faster data transfer rates of the USB storage devices.
- **STORAGE BOOST** - supports faster access speed of storage device.

Important

- Please note that you can only select one mode at a time from Easy or Advance page as **MSI X-BOOST** function.
- The improved transfer rate/ access speed will vary with the USB/ storage device.

MSI SMART TOOL

MSI SMART TOOL is a convenient tool that can help you to create your Windows installation USB flash drive with USB 3.0 drivers, and it can also create a SUPER RAID.

Main menu

After installing and activating MSI SMART TOOL, it will display a main menu for you to choose **Win7 Smart Tool** or **SUPER RAID**. Note that the SUPER RAID is only available when your system equipped with at least 3 hard-disk drives (1 system disk and 2 data disks).

WIN7 SMART TOOL

Before you can create your Windows installation USB flash drive, you'll need to have your Windows Installation DVD or ISO file, and also have a minimum of a 8GB USB flash drive to create your installer. Be sure to backup files on the USB drive, this process will erase it.



To create the Windows installation USB drive:

Step1. Choose source folder

- In the **Source folder** box, type the name and path of your Windows ISO file, or click **Browse** button and select the file from the dialog box. (This option will copy all Windows installation files and USB 3.0 drivers)
- If you already have the Windows Installation USB flash drive and just want to add USB 3.0 drivers on it, you can choose **Add USB drivers**.

Step2. Choose Storage device

- Choose **USB storage** and select your USB flash drive in the drop-down list. In case the USB flash drive is not listed, click the **Refresh Drive** button.
- If you want to install Windows on the NVMe SSD, check the **Add NVMe driver** checkbox to copy NVMe drivers to the USB flash drive.
- Click **Start**.



Important

You can also create an installer ISO image file by selecting the **ISO destination** in Step2, and then burn it onto the DVD.

SUPER RAID

This utility allows you to create a SUPER RAID in Windows system.



To create a SUPER RAID:

1. Use checkboxes to select the disks you want included in your RAID.
2. Choose **Speed Up** or **Backup** for RAID type.
 - Speed Up = RAID0
 - Backup = RAID1
3. Click **Start**.
4. When prompt **Finish!**, click **OK**.



Important

SUPER RAID can't include the system disk.

GAMING LAN MANAGER

GAMING LAN MANAGER is an utility for traffic shaping for the Windows 7/ 10. It can keep your internet fast during heavy upload/ download and improve your ping for online games. If your motherboard has a Wi-Fi module, GAMING LAN MANAGER provides virtual access point function for traffic shaping for your mobile devices.

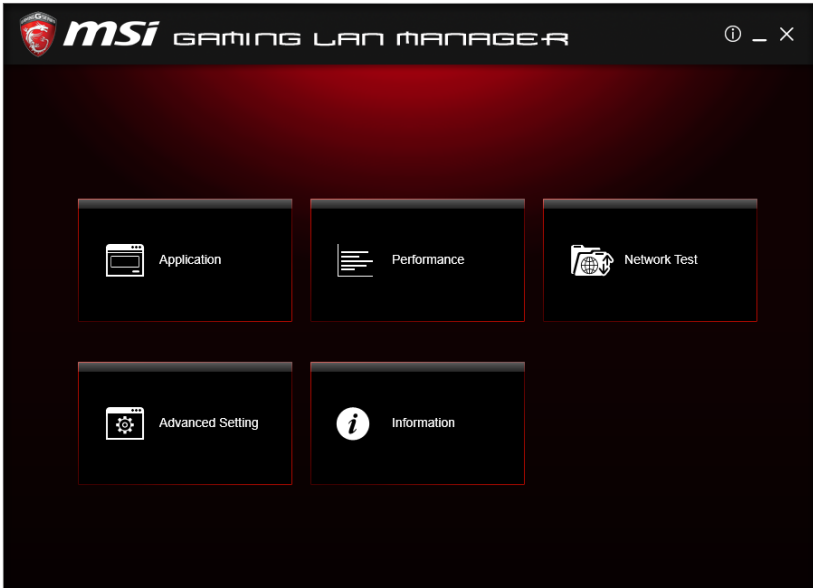

- **Applications** - displays currently using network bandwidth applications. You can prioritize Games, Medias or File sharing programs as high as possible.
- **Performance** - shows top 5 applications by total traffic, allows you to monitor network bandwidth usage.
- **Network Test** - allows you to setup bandwidth control.
- **Advanced Setting** - allows you to expand RWIN to accelerate download speed. You can also block IP address and setup virtual access point.
- **Information** - shows version information.

Configuring Bandwidth

This section describes how to configure Internet Provider Speed. You can configure default internet upload and download bandwidth from the Network Test tab on the GAMING LAN MANAGER window.

Important

*Before using the GAMING LAN MANAGER for the first time, you should use the **Test Network Speed** button which runs a speed test of your current total Internet bandwidth delivered through your Internet service provider.*

Speed Testing

The speed testing is used to optimize bandwidth usage. To test the Upload and Download speed, please follow the steps below:

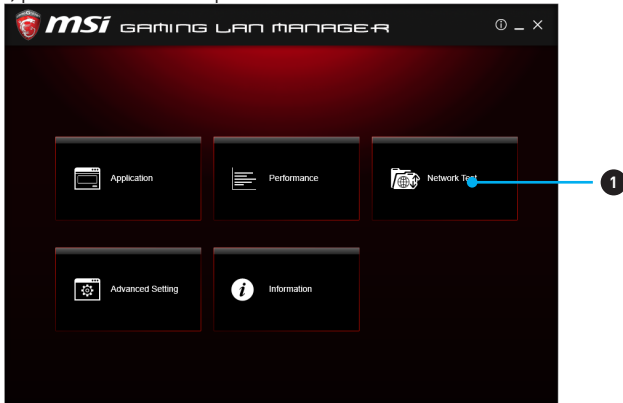

1. Click the **Network Test** block in GAMING LAN MANAGER.

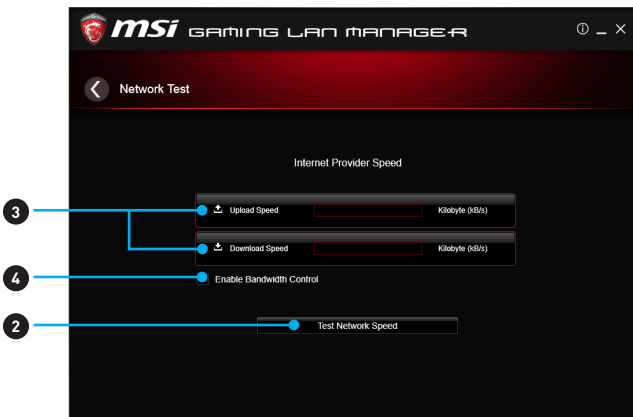

2. Click **Test Network Speed** button. The test takes several minutes to test your network speed.
3. Enter the testing results into **Upload Speed** and **Download Speed** fields.
4. Check the **Enable Bandwidth Control** to allow the GAMING LAN MANAGER to manage the bandwidth.

DRAGON EYE

DRAGON EYE is an application that allows you to watch a game guide, tutorial, live match or tournament stream while playing a game. In the game, you can use hotkeys to control / adjust the window of video.

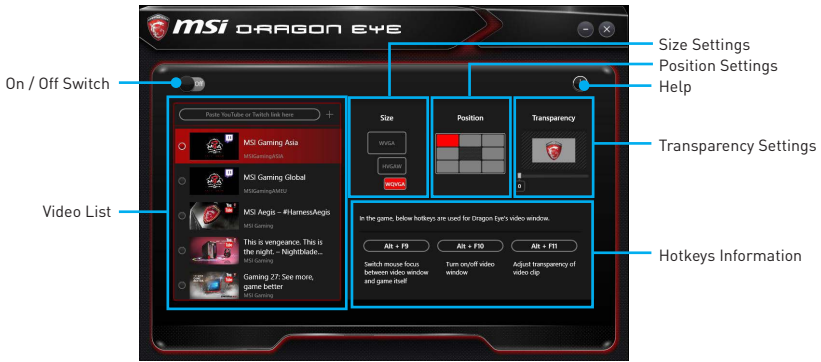

- **On / Off Switch** - enables or disables Dragon Eye during your gaming sessions. Switch it on before you launch the game in order to watch video while playing.
- **Video List** - allows you to select the video you want to watch, and also add videos or channels to the list. You simply paste the URL of your video or stream into the input bar and hit the +. Then your video or stream will be in the list and you can select it to view it with Dragon Eye.
- **Size Settings** - allows you to select the size of the Dragon Eye video content displayed on-screen when you're playing a game. There are three options available:
 - WQVGA (Small – 400 × 240)
 - HVGA (Medium – 640 × 360)
 - WVGA (Large – 768 × 480)
- **Position Settings** - allows you to select where the Dragon Eye video needs to be displayed on screen. This way you can control where you want your video in-game, so you can place it on a place where no important game information is.
- **Help** - If you want to watch the video tutorial for Dragon Eye or want to see if your game is supported, press this button and the help window will be shown.
- **Transparency Settings** - allows you to set the transparency of your Dragon Eye video.
 - 0 = opaque | 100 = transparent.
- **Hotkeys Information** - In this information screen you can find the hotkeys for Dragon Eye. There are three hotkeys:
 - **Alt+F9** - switches mouse focus between video window and game itself. (Direct interface to adjust progress bar, volume and other settings of video during the game)
 - **Alt+F10** - turns on/off video window .
 - **Alt+F11** - adjusts transparency of video clip.

NOTE: To customize hotkey, simply select the hotkey icon and then press the keys combination you want to use as a hotkey.

XSplIt Gamecaster V2

XSplIt Gamecaster is the newest product from SplitmediaLabs, the creators of XSplIt Broadcaster, the world's most popular streaming application.

XSplIt Gamecaster was designed to provide gamers with the simplest and most uncomplicated way to create high quality gameplay recordings and live streams. By utilizing the revolutionary in-game overlay, streamlined encoding, and social network features, you'll be sharing your gameplay to your family, friends, and followers in no time!

Logging

After installing and activating XSplIt Gamecaster V2, it will display a login dialogue. If you already have an account and password, fill your email and password into the form and click the **Login** button.

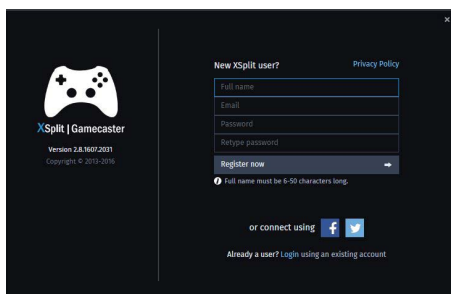

Important

When starting XSplIt Gamecaster V2 on select MSI® gaming laptops, all-in ones or on machines that contain select MSI® motherboards or graphics cards, you will receive a free 6 month XSplIt premium license that you can apply to an existing free account or to a new account. If you already have an XSplIt account with a personal or premium license, then you can instead add 6 months to your license duration.

Registering an Account

If you don't have an XSplIt account yet, click **Register now** on the login dialogue. When the user registration form appears, complete all the fields.

Learning stream and record

Refer to the Start page of XSplit Gamecaster V2 to learn how to stream and record your gameplay.

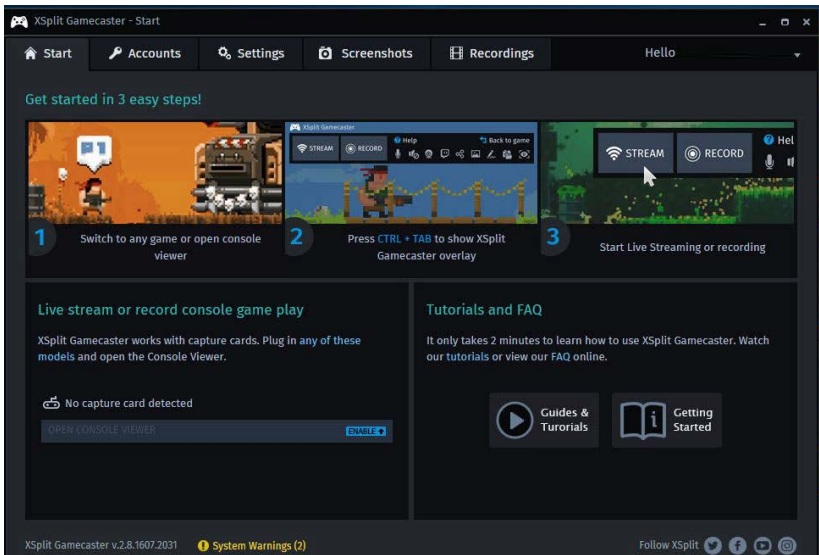

Tool Tip

When you click the question mark next to a feature name on the panel, a tooltip will show, describing the particular function of that item.

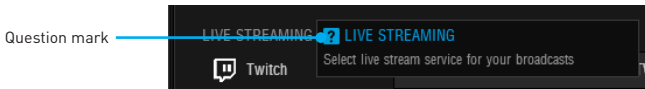

Inside the XSplit Gamecaster Overlay

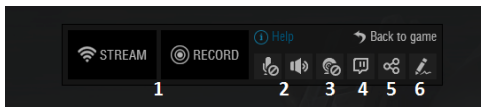

1. **Streaming/Recording Buttons** - Press Stream to start live streaming or Record to start recording.
2. **Microphone/System Sound Control** - Pressing the microphone or system sound button will enable or disable the microphone or system sound.
3. **Webcam Controls** - To enable webcam controls, you must first select a camera/webcam in the Settings Tab. Once you have selected a webcam, you can activate it by clicking on its icon in the XSplit Gamecaster V2 overlay.
4. **Twitch Chat Controls** - If you've signed in to your Twitch.tv account, you'll see a Twitch icon in the overlay. When you click on this icon, a window will open. This window is XSplit Gamecaster's integrated chat system.

5. **Share Button** - If you authorize your Facebook, Twitter, and/or Google+ accounts, you can quickly share your stream URL and status update within the overlay.
6. **Annotations** - This feature of XSplit Gamecaster V2 allows you to draw directly onto your game play. You can activate annotation mode by clicking on the pencil button in the overlay.

Accounts Tab

- **Live Streaming** - allows you to stream to a variety of live streaming services such as **YouTube, Twitch, Ustream, Dailymotion, Niconico** and also allows for custom RTMP streaming.
- **Video Sharing** - allows you to directly upload recordings to **YouTube** from within the software.
- **Social Network** - allows you to share your live stream or YouTube links to friends & followers on **Google+, Facebook, and Twitter**. To allow XSplit Gamecaster to post on your desired social network, click on the **Authorize To Post On...** button of your desired social network and enter your username and password to authorize.

Settings Tab

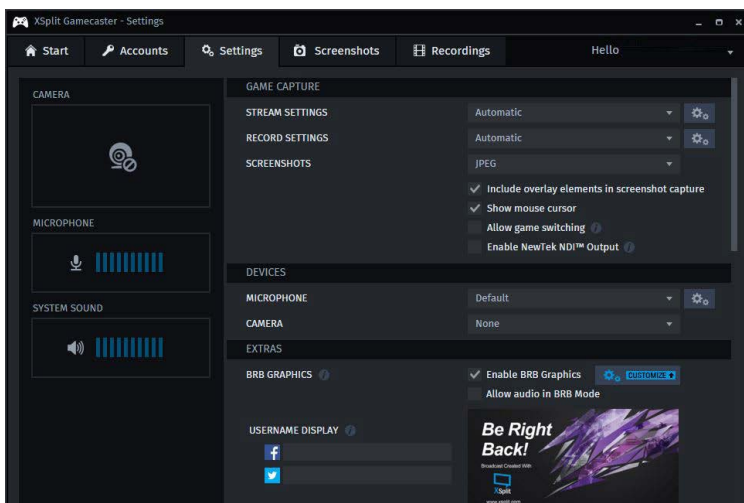

- **Stream Settings** - The default setting is Automatic mode. In Automatic mode, your stream settings are automatically determined by XSplit Gamecaster based on your computer and internet resources (this includes resolution, bitrate, codec, but frame is always set to 30). You can change to a different resolution by clicking on the drop-down arrow.
- **Record Settings** - The default setting for recording is Original Resolution. This refers to the resolution of the game that's been set inside the game's video/graphics settings. You can change to a different resolution by clicking on the drop-down arrow.

- **Microphone Settings** - In this region, you can select your desired microphone. What is shown in the list depends on what you have connected to your PC. If you don't see your desired device in the list, please make sure that it is detected and it is not disabled in your recording devices list in the Windows® Sound Menu (**Start > Control Panel > Sound > Recording**).
- **Camera Settings** - In this region, you can select your desired camera. What is shown in the list depends on the cameras you have connected to your PC (**Control Panel > Device Manager > Imaging Devices**).
- **BRB Graphics (Be-Right-Back Graphics)** - BRB Graphics are activated when you alt-tab or minimize your game. BRB Graphics will not work in Console Viewer mode. You can enter the BRB Graphics editor by clicking on the gear icon next to the BRB Graphics preview.

Recordings Tab

- **Arranging Recordings** - In the Recordings Tab, you can view your recordings as thumbnails or in a listed format by clicking on the  button in the top right corner of the window. You can sort your recordings by name, date, length, and size by right clicking in the Recordings Tab.
- **Opening Recordings Folder** - To open your recordings folder in Windows® Explorer, click on **Open Folder**.
- **Changing Recordings Location** - To change the location of where your videos will be saved, click on the recordings folder location.
- **Uploading video recordings to YouTube** - To upload to YouTube, you must first authorize your account in the Accounts Tab. After you have authorized your account, click on a recording and then click on the YouTube logo in the bottom right corner. A window will open and you will be able to fill out the title, description, category, tags, privacy, and you will be able to choose to allow or disallow embedding. Once you have entered the details for YouTube, press the Upload Now button.
- **Sharing on Social Media** - Once a video has been uploaded, you can share the YouTube link on any social media accounts you have connected to XSplit Gamecaster. Simply click on the icon of the social media site you wish to share, and a window will appear where you can enter some details about your post before publishing your link. When you are done entering the details of your post, click Share Video to post it to your selected social media account.

SteelSeries Engine 3

SteelSeries Engine 3 is a unified platform built to support all of SteelSeries products. It can deploy your saved device settings automatically when switching between your favorite games or applications.

After installation the SteelSeries Engine background processes will start and the interface will open automatically.

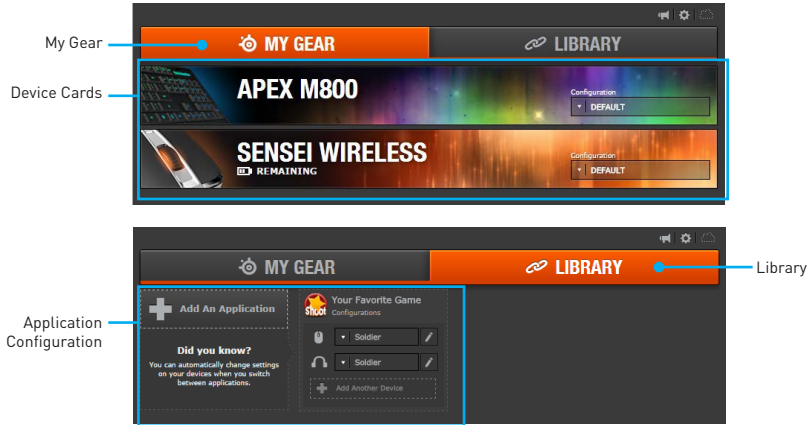

- **My Gear** - all of your SteelSeries devices in one place.
 - **Device Cards** - all of your SteelSeries devices are easily accessible from the My Gear tab, regardless of type, connection status, or which applications they are assigned to.
- **Library** - quickly set up your configurations to autolaunch with an application.
 - **Application Configuration** - you can choose to have configurations deploy automatically whenever you use a specific game or application. Add any number of applications to your library and SteelSeries Engine 3 will seamlessly change the configurations of your devices as you switch between them.

Configuration Windows

Configuration Windows are unique to their devices and each of them includes a collapsible **Configuration List Panel** of all the configurations for that device. You can create a new configuration by selecting the **New** button at the bottom of the Configuration List Panel.

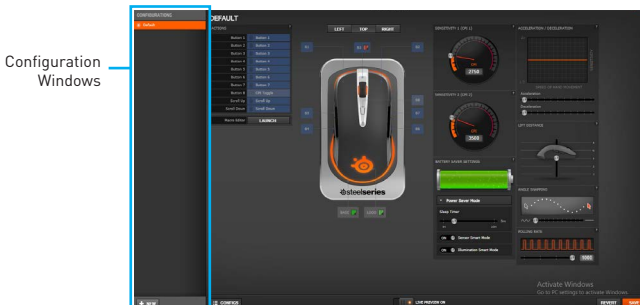

Configuring Your Devices

You can custom configurations for SteelSeries devices in their Configuration Windows. The top left displays the name of the configuration you are viewing, the body features widgets for customizing various functions of the device, and at the bottom are Save/ Revert buttons, a Live Preview toggle, and a button to open/close the collapsible Configuration List Panel.

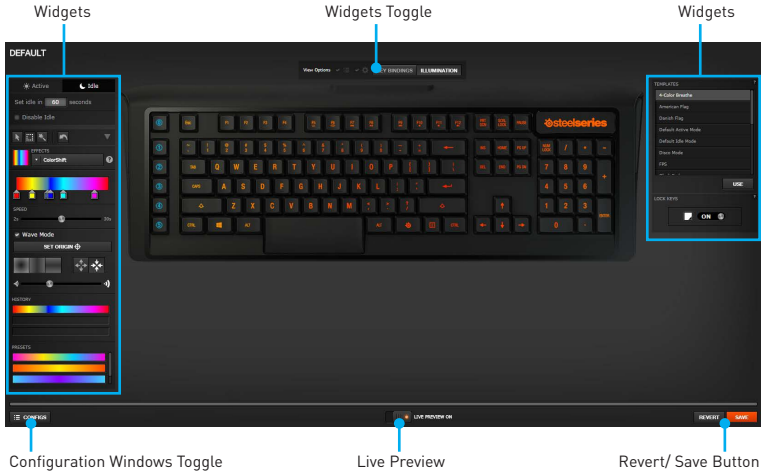

- **Widgets** - allow you to customize a certain aspect of your device.
- **Widgets Toggle** - allows you to toggle Widgets .
- **Configuration Windows Toggle** - allows you to toggle the Configuration Windows.
- **Live Preview** - gives you the full experience of your configuration's look, feel, and sound while you are editing it.
- **Revert/ Save Button** - configuration changes are not written to the database until you select **Save**. This gives you freedom to experiment, knowing that you can select **Revert** to undo changes.

Tool Tip

When you click the question mark next to a feature name on the panel, a tooltip will show, describing the particular function of that item.

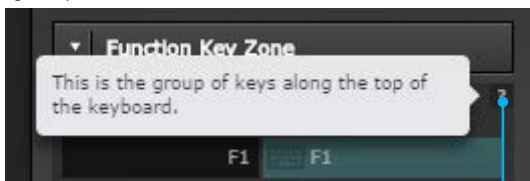

Question Mark

CPU-Z

CPU-Z is a utility that gathers information on some of the main devices of your system.

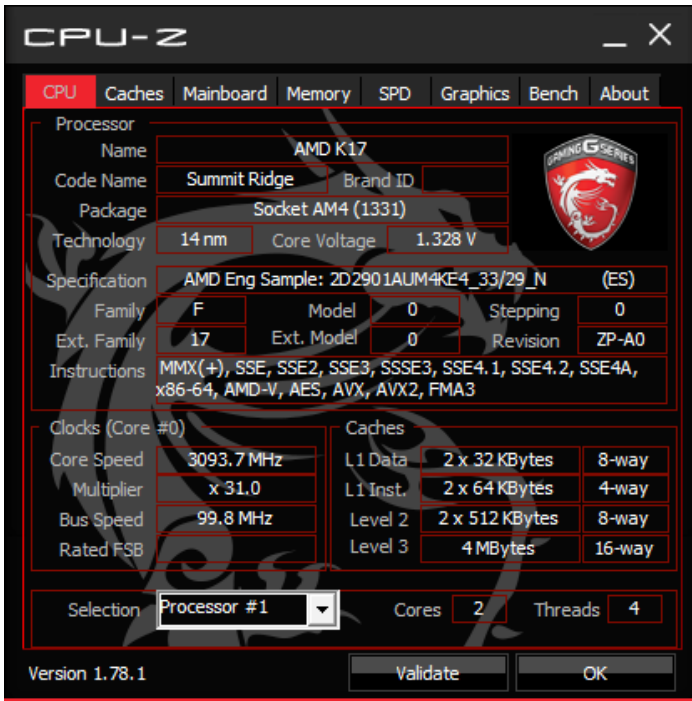

- **CPU Tab** - shows processor name, code name, package, specification, instructions sets, core speed and cache levels.
- **Caches Tab** - shows extended information related to the cache capabilities.
- **Mainboard Tab** - shows motherboard manufacturer, model name, chipset, BIOS version and graphic interface.
- **Memory Tab** - shows memory type, memory size, channels, memory frequency.
- **SPD Tab** - shows specifications relating to each memory module connected to the motherboard, including the size, type and frequency.
- **Graphics Tab** - shows GPU name, code name, core speed, memory size, and memory type.
- **Bench Tab** - allows you to run either a benchmark or a stress test on your processor.
- **About Tab** - shows the CPU-Z version, Windows version, DirectX version and allows you to save the report file.

Troubleshooting

Before sending the motherboard for RMA repair, try to go over troubleshooting guide first to see if your got similar symptoms as mentioned below.

The power is not on.

- Connect the AC power cord to an electrical outlet securely.
- Check if all ATX power connectors like **ATX_PWR1**, **CPU_PWR1** are connected from the power supply to the motherboard?
- Some power supply units have a power button on the rear side, make sure the button is turned on.
- Check if the power switch cable is connected to **JFP1** pin header properly.
- Verify the **Clear CMOS** jumper **JBAT1** is set to **Keep DATA**.
- Test with another known working power supply of equal or greater wattage.

The power is on, but no signal to monitor

- Connect the monitor power cord to a electrical outlet securely.
- Make sure the monitor is turned on.
- Select different inputs on the monitor.
- If 3 long beeps are heard, remove all memory modules and try to install only one memory module in the **DIMMA2** slot first and then restart the computer.
- If 1 long 2 short beeps are heard, remove and reinstall the graphics card and then restart the computer.
- Test with another known working graphics card.

The computer does not boot after updating the BIOS

- Clear the CMOS.
- Use the secondary BIOS to bootup the system (Only for motherboard with Dual BIOS)

Lost BIOS password

- Clear the CMOS, but that will cause you to lose all customized settings in the BIOS.

There is no audio

- Adjust the volume.
- Connect the speakers/headphones to audio ports on the motherboard rear IO panel.
- Remove secondary speakers/headphones, HDMI cables, USB audio devices.
- Test with another known working speaker or headphone.

There is no network

- Make sure the network chipset driver has been installed.
- Verify if the network cable is properly connected and make sure the LAN port LEDs are properly illuminated.
- Verify your TCP/IP settings.
- Restart or reset your router.
- Test with another known working LAN cable.

The USB device is not working

- Make sure your USB drive driver has been installed.
- Verify if USB device is listed in Windows® Device Manager.
- Connect the USB device to other USB port on the motherboard rear IO panel.

Regulatory Notices

FCC Compliance Statement

Note: This equipment has been tested and found to comply with the limits for a Class B digital device, pursuant to part 15 of the FCC Rules. These limits are designed to provide reasonable protection against harmful interference in a residential installation. This equipment generates, uses and can radiate radio frequency energy and, if not installed and used in accordance with the instructions, may cause harmful interference to radio communications. However, there is no guarantee that interference will not occur in a particular installation. If this equipment does cause harmful interference to radio or television reception, which can be determined by turning the equipment off and on, the user is encouraged to try to correct the interference by one or more of the following measures:

- Reorient or relocate the receiving antenna.
- Increase the separation between the equipment and receiver.
- Connect the equipment into an outlet on a circuit different from that to which the receiver is connected.
- Consult the dealer or an experienced radio/TV technician for help.

Caution: Changes or modifications not expressly approved by the party responsible for compliance could void the user's authority to operate the equipment.

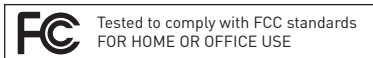

This device complies with part 15 of the FCC Rules. Operation is subject to the following two conditions:
(1) This device may not cause harmful interference, and
(2) this device must accept any interference received, including interference that may cause undesired operation.

CE Conformity

 Hereby, Micro-Star International CO., LTD declares that this device is in compliance with the essential safety requirements and other relevant provisions set out in the European Directive.

C-Tick Compliance



B급 기기 (가정용 방송통신기자재)

 이 기기는 가정용(B급) 전자파적합기기로서 주 로 가정에서 사용하는 것을 목적으로 하며, 모든 지역에서 사용할 수 있습니다.

クラスB情報技術装置

 この装置は、クラスB情報技術装置です。この装置は、家庭環境で使用することを目的としていますが、この装置がラジオやテレビジョン受信機に近接して使用されると、受信障害を引き起こすことがあります。取扱説明書に従って正しい取り扱いをして下さい

VCCI-B

Battery Information

European Union:



Batteries, battery packs, and accumulators should not be disposed of as unsorted household waste. Please use the public collection system to return, recycle, or treat them in compliance with the local regulations.

Taiwan:



廢電池請回收

For better environmental protection, waste batteries should be collected separately for recycling or special disposal.

California, USA:



The button cell battery may contain perchlorate material and requires special handling when recycled or disposed of in California.

For further information please visit:

<http://www.dtsc.ca.gov/hazardouswaste/perchlorate/>

CAUTION: There is a risk of explosion, if battery is incorrectly replaced.
Replace only with the same or equivalent type recommended by the manufacturer.

Chemical Substances Information

In compliance with chemical substances regulations, such as the EU REACH Regulation (Regulation EC No. 1907/2006 of the European Parliament and the Council), MSI provides the information of chemical substances in products at:
http://www.msi.com/html/popup/csr/evmtprtt_pcm.html

WEEE (Waste Electrical and Electronic Equipment) Statement

ENGLISH

To protect the global environment and as an environmentalist, MSI must remind you that...

Under the European Union ("EU") Directive on Waste Electrical and Electronic Equipment, Directive 2002/96/EC, which takes effect on August 13, 2005, products of "electrical and electronic equipment" cannot be discarded as municipal wastes anymore, and manufacturers of covered electronic equipment will be obligated to take back such products at the end of their useful life. MSI will comply with the product take back requirements at the end of life of MSI-branded products that are sold into the EU. You can return these products to local collection points.



DEUTSCH

Hinweis von MSI zur Erhaltung und Schutz unserer Umwelt

Gemäß der Richtlinie 2002/96/EG über Elektro- und Elektronik-Altgeräte dürfen Elektro- und Elektronik-Altgeräte nicht mehr als kommunale Abfälle entsorgt werden. MSI hat europaweit verschiedene Sammel- und Recyclingunternehmen beauftragt, die in die Europäische Union in Verkehr gebrachten Produkte, am Ende seines Lebenszyklus zurückzunehmen. Bitte entsorgen Sie dieses Produkt zum gegebenen Zeitpunkt ausschliesslich an einer lokalen Altgerätesammelstelle in Ihrer Nähe.

FRANÇAIS

En tant qu'écologiste et afin de protéger l'environnement, MSI tient à rappeler ceci... Au sujet de la directive européenne (EU) relative aux déchets des équipements électriques et électroniques, directive 2002/96/EC, prenant effet le 13 août 2005, que les produits électriques et électroniques ne peuvent être déposés dans les décharges ou tout simplement mis à la poubelle. Les fabricants de ces équipements seront obligés de récupérer certains produits en fin de vie. MSI prendra en compte cette exigence relative au retour des produits en fin de vie au sein de la communauté européenne. Par conséquent vous pouvez retourner localement ces matériels dans les points de collecte.

РУССКИЙ

Компания MSI предпринимает активные действия по защите окружающей среды, поэтому напоминаем вам, что... В соответствии с директивой Европейского Союза (ЕС) по предотвращению загрязнения окружающей среды использованным электрическим и электронным оборудованием [директива WEEE 2002/96/ЕС], вступающей в силу 13 августа 2005 года, изделия, относящиеся к электрическому и электронному оборудованию, не могут рассматриваться как бытовой мусор, поэтому производители вышеперечисленного электронного оборудования обязаны принимать его для переработки по окончании срока службы. MSI обязуется соблюдать требования по приему продукции, проданной под маркой MSI на территории ЕС, в переработку по окончании срока службы. Вы можете вернуть эти изделия в специализированные пункты приема.

ESPAÑOL

MSI como empresa comprometida con la protección del medio ambiente, recomienda: Bajo la directiva 2002/96/EC de la Unión Europea en materia de desechos y/o equipos electrónicos, con fecha de rigor desde el 13 de agosto de 2005, los productos clasificados como "eléctricos y equipos electrónicos" no pueden ser depositados en los contenedores habituales de su municipio, los fabricantes de equipos electrónicos, están obligados a hacerse cargo de dichos productos al término de su periodo de vida. MSI estará comprometido con los términos de recogida de sus productos vendidos en la Unión Europea al final de su periodo de vida. Usted debe depositar estos productos en el punto limpio establecido por el ayuntamiento de su localidad o entregar a una empresa autorizada para la recogida de estos residuos.

NEDERLANDS

Om het milieu te beschermen, wil MSI u eraan herinneren dat...

De richtlijn van de Europese Unie (EU) met betrekking tot Vervuiling van Electricische en Electronische producten (2002/96/EC), die op 13 Augustus 2005 in zal gaan kunnen niet meer beschouwd worden als vervuiling. Fabrikanten van dit soort producten worden verplicht om producten retour te nemen aan het eind van hun levenscyclus. MSI zal overeenkomstig de richtlijn handelen voor de producten die de merknaam MSI dragen en verkocht zijn in de EU. Deze goederen kunnen geretourneerd worden op lokale inzamelingspunten.

SRPSKI

Da bi zaštitili prirodnu sredinu, i kao proizvođače koje vodi računa o okolini i prirodnoj sredini, MSI mora da vas podesti da... Po Direktivi Evropske unije ("EU") o odbačenoj elektonskoj i električnoj opremi, Direktiva 2002/96/EC, koja stupa na snagu od 13. Avgusta 2005, proizvođači koji spadaju pod "elektronsku i električnu opremu" ne mogu više biti odbačeni kao običan otpad i proizvođači ove opreme biće prinudeni da uzmu natrag ove proizvode na kraju njihovog uobičajenog veka trajanja. MSI će poštovati zahtev o preuzimanju ovakvih proizvoda kojima je istekao vek trajanja, koji imaju MSI oznaku i koji su prodati u EU. Ove proizvode možete vratiti na lokalnim mestima za prikupljanje.

POLSKI

Aby chronić nasze środowisko naturalne oraz jako firma dbająca o ekologię, MSI przypomina, że... Zgodnie z Dyrektywą Unii Europejskiej ("UE") dotycząca odpadów produktów elektrycznych i elektronicznych (Dyrektywa 2002/96/EC), która wchodzi w życie 13 sierpnia 2005, tzw. "produkty oraz wyposażenie elektryczne i elektroniczne" nie mogą być traktowane jako śmieci komunalne, tak więc producenci tych produktów będą zobowiązani do odbierania ich w momencie gdy produkt jest wycofywany z użycia. MSI wypełni wymagania UE, przyjmując produkty [sprzedawane na terenie Unii Europejskiej] wycofywane z użycia. Produkty MSI będzie można zwracać w wyznaczonych punktach zbiorczych.

TÜRKÇE

Çevreci özelliğiyle bilinen MSI dünyada çevreyi korumak için hatırlatır:
Avrupa Birliği (AB) Kararnamesi Elektrik ve Elektronik Malzeme Atığı, 2002/96/EC Kararnamesi altında 13 Ağustos 2005 tarihinden itibaren geçerli olmak üzere, elektrikli ve elektronik malzemeler diğer atıklar gibi çöpe atılmayacak ve bu elektronik cihazların üreticileri, cihazların kullanim süreleri bittikten sonra ürünleri geri toplamakla yükümlü olacaktır. Avrupa Birliği'ne satılan MSI markalı ürünlerin kullanim süreleri bittiğinde MSI ürünlerin geri alınması isteği ile işbirliği içerisinde olacaktır. Ürünlerinizi yerel toplama noktalarına bırakabilirsiniz.

ČESKY

Záleží nám na ochraně životního prostředí - společnost MSI upozorňuje...

Podle směrnice Evropské unie ("EU") o likvidaci elektrických a elektronických výrobků 2002/96/EC platné od 13. srpna 2005 je zakázáno likvidovat "elektrické a elektronické výrobky" v běžném komunálním odpadu a výrobci elektrických výrobků, na které se tato směrnice vztahuje, budou povinni odebírat takové výrobky zpět po skončení jejich životnosti. Společnost MSI splní požadavky na odebrání výrobků značky MSI, prodávaných v zemích EU, po skončení jejich životnosti. Tyto výrobky můžete odevzdat v místních sběrnách.

MAGYAR

Annak érdekében, hogy környezetünk megvédjük, illetve környezetvédekként fellépve az MSI emlékezteti Önt, hogy ...
Az Európai Unió („EU”) 2005. augusztus 13-án hatályba lépő, az elektromos és elektronikus berendezések hulladékairól szóló 2002/96/EK irányelve szerint az elektromos és elektronikus berendezések többé nem kezelhetőek lakossági hulladékként, és az ilyen elektronikus berendezések gyártói kötelesek válnak az ilyen termékek visszavételére azok hasznos élettartama végén. Az MSI betartja a termékviszavétellel kapcsolatos követelményeket az MSI márkanév alatt az EU-n belül értékesített termékek esetében, azok élettartamának végén. Az ilyen termékeket a legközelebbi gyűjtőhelyre viheti.

ITALIANO

Per proteggere l'ambiente, MSI, da sempre amica della natura, ti ricorda che...
In base alla Direttiva dell'Unione Europea (EU) sullo Smaltimento dei Materiali Elettrici ed Elettronici, Direttiva 2002/96/EC in vigore dal 13 Agosto 2005, prodotti appartenenti alla categoria dei Materiali Elettrici ed Elettronici non possono più essere eliminati come rifiuti municipali: i produttori di detti materiali saranno obbligati a ritirare ogni prodotto alla fine del suo ciclo di vita. MSI si addeguerà a tale Direttiva ritirando tutti i prodotti marchiati MSI che sono stati venduti all'interno dell'Unione Europea alla fine del loro ciclo di vita. È possibile portare i prodotti nel più vicino punto di raccolta

日本JIS C 0950材質宣言

日本工業規格JIS C 0950により、2006年7月1日以降に販売される特定分野の電気および電子機器について、製造者による含有物質の表示が義務付けられます。
http://www.msi.com/html/popup/csr/cemm_jp.html
http://tw.msi.com/html/popup/csr_tw/cemm_jp.html

India RoHS

This product complies with the "India E-waste (Management and Handling) Rule 2011" and prohibits use of lead, mercury, hexavalent chromium, polybrominated biphenyls or polybrominated diphenyl ethers in concentrations exceeding 0.1 weight % and 0.01 weight % for cadmium, except for the exemptions set in Schedule 2 of the Rule.

Türkiye EEE yönetmeli 7

Türkiye Cumhuriyeti: EEE Yönetmeli ine Uygundur

Україна обмеження на наявність небезпечних речовин

Обладнання відповідає вимогам Технічного регламенту щодо обмеження використання деяких небезпечних речовин в електричному та електронному обладнанні, затвердженого постановою Кабінету Міністрів України від 3 грудня 2008 № 1057.

Việt Nam RoHS

Kể từ ngày 01/12/2012, tất cả các sản phẩm do công ty MSI sản xuất tuân thủ Thông tư số 30/2011/TT-BCT quy định tạm thời về giới hạn hàm lượng cho phép của một số hóa chất độc hại có trong các sản phẩm điện, điện tử"

Environmental Policy

- The product has been designed to enable proper reuse of parts and recycling and should not be thrown away at its end of life.
- Users should contact the local authorized point of collection for recycling and disposing of their end-of-life products.
- Visit the MSI website and locate a nearby distributor for further recycling information.
- Users may also reach us at gpcontdev@msi.com for information regarding proper Disposal, Take-back, Recycling, and Disassembly of MSI products.



产品中有害物质的名称及含量

部件名称	有害物质					
	铅 (Pb)	汞 (Hg)	镉 (Cd)	六价铬 (Cr(VI))	多溴联苯 (PBB)	多溴二苯醚 (PBDE)
印刷电路板组件*	X	0	0	0	0	0
电池** 	X	0	0	0	0	0
外部信号连接头	X	0	0	0	0	0
线材	X	0	0	0	0	0

本表格依据 SJ/T 11364 的规定编制。

0: 表示该有害物质在该部件所有均质材料中的含量均在 GB/T 26572 规定的限量要求以下。

X: 表示该有害物质至少在该部件的某一均质材料中的含量超出 GB/T 26572 规定的限量要求, 但所有部件都符合欧盟 RoHS 要求。

* 印刷电路板组件: 包括印刷电路板及其构成的零部件。

** 电池本体上如有环保使用期限标识, 以本体标识为主。

■ 上述有毒有害物质或元素清单会依型号之部件差异而有所增减。

■ 产品部件本体上如有环保使用期限标识, 以本体标识为主。

Copyright

msi Micro-Star Int'l Co., Ltd.
Copyright © 2017 All rights reserved.

The material in this document is the intellectual property of Micro-Star Int'l Co., Ltd. We take every care in the preparation of this document, but no guarantee is given as to the correctness of its contents. Our products are under continual improvement and we reserve the right to make changes without notice.

Technical Support

If a problem arises with your system and no solution can be obtained from the user guide, please contact your place of purchase or local distributor. Alternatively, please try the following help resources for further guidance.

- Visit the MSI website for technical guide, BIOS updates, driver updates, and other information: <http://www.msi.com>
- Register your product at: <http://register.msi.com>

Trademark Recognition

All product names used in this manual are the properties of their respective owners and are acknowledged.

Revision History

Version 2.0, 2017/02, For X370 SLI PLUS
Version 2.1, 2017/03, For X370 GAMING PRO